

Effect of Valve Pressure Drop in Exergy Analysis of C_2^+ Recovery Plants Refrigeration Cycles

B. Tirandazi, M. Mehrpooya and A. Vatani

Abstract—This paper provides an exergy analysis of the multistage refrigeration cycle used for C_2^+ recovery plant. The behavior of an industrial refrigeration cycle with refrigerant propane has been investigated by the exergy method. A computational model based on the exergy analysis is presented for the investigation of the effects of the valves on the exergy losses, the second law of efficiency, and the coefficient of performance (COP) of a vapor compression refrigeration cycle. The equations of exergy destruction and exergetic efficiency for the main cycle components such as evaporators, condensers, compressors, and expansion valves are developed. The relations for the total exergy destruction in the cycle and the cycle exergetic efficiency are obtained. An ethane recovery unit with its refrigeration cycle has been simulated to prepare the exergy analysis. Using a typical actual work input value; the exergetic efficiency of the refrigeration cycle is determined to be 39.90% indicating a great potential for improvements. The simulation results reveal that the exergetic efficiencies of the heat exchanger and expansion sections get the lowest rank among the other compartments of refrigeration cycle. Refrigeration calculations have been carried out through the analysis of T-S and P-H diagrams where coefficient of performance (COP) was obtained as 1.85. The novelty of this article includes the effect and sensitivity analysis of molar flow, pressure drops and temperature on the exergy efficiency and coefficient of performance of the cycle.

Keywords—exergy; Valve; CRP; refrigeration cycle; propane refrigerant; C_2^+ Recovery; Ethane Recovery;.

I. INTRODUCTION

THE first law analysis method is widely used to evaluate thermodynamic systems; however, this method is concerned only with energy conservation, and therefore it cannot show how or where irreversibility occurs in a system or process. To determine the irreversibility, the exergy analysis method is applicable, providing an indicator that points in which direction efforts should concentrate to improve the performance of the thermodynamic systems [2].

B. Tirandazi Department of Chemical Engineering, Faculty of Engineering, University of Tehran, P.O.Box: 33316-19636, Tehran, Iran. (E-mail: behnam.tirandazi@gmail.com).

M. Mehrpooya Department of Chemical Engineering, Faculty of Engineering, University of Tehran, P.O.Box: 33316-19636, Tehran, Iran. (E-mail: mehdimp@gmail.com)

A. vatani Department of Chemical Engineering, Faculty of Engineering, University of Tehran, P.O.Box: 33316-19636, Tehran, Iran. (E-mail: avatani@ut.ac.ir)

The general principles and methodology of exergy analysis can be found in [3-7]. An exergy analysis is usually aimed at determining the maximum performance of the system and identifies the sites of exergy destruction. Exergy analysis of a complex system can be performed by analyzing the components of the system separately. The loss of exergy, or irreversibility, provides a generally applicable quantitative measure of process inefficiency. Analyzing a multi-component plant indicates the total plant irreversibility distribution among the plant components, pinpointing those contributing most to overall plant inefficiency [6]. There have been several studies on the exergy analysis of refrigeration systems [2,8-21]. The behavior of two stage compound compression-cycle, with flash intercooling, using refrigerant R22, investigated by the exergy method [9] and an exergy analysis carried out for an irreversible Braysson cycle by Zheng et al. [11]. Yumrutas, et al [12] presented a computational model based on the exergy analysis for the investigation of the effects of the evaporating and condensing temperature on the pressure losses, the exergy losses and performance of a vapour compression refrigeration cycle. An exergy analysis of small-scale liquefied natural gas (LNG) liquefaction processes carried out by Remelje and Hoadley [16]. Analysis of a combined power and refrigeration cycle by the exergy method is presented by Vidal et al. [2]. Mehrpooya [17] illustrated Simulation and exergy-method analysis of an industrial refrigeration cycle used in NGL recovery units. Exergy maximization of cascade refrigeration cycles and numerical verification for a transcritical CO_2 - C_3H_8 system carried out by Bhattacharyya and Sarkar [19]. Methodology for thermal design of novel combined refrigeration/power binary fluid systems carry out by; Zhang et al [18] and Khaliq and Kumar [21] presented Exergy analysis of double effect vapor absorption refrigeration system. Kabul, et al. [20] described Performance and exergetic analysis of vapor compression refrigeration system with an internal heat exchanger using a hydrocarbon, isobutene (R600a).

In this paper the exergy equations have been developed using refrigerant thermodynamic properties computed by means of a simple model of local equations of states. Next exergy analysis is applied to the refrigeration cycle. Then exergy losses (lost work) and exergetic efficiencies for each component of refrigeration cycle were calculated. Furthermore it will be easy to identify which sites of cycle should be optimized and what is the effect of optimal coefficient of performance (COP) on energy integration. The expression for the exergy losses (lost works) that make up the cycle as well as

the coefficient of performance (COP) and second law efficiency for the entire cycle are obtained. Effects of expansion pressure and condensing temperatures on the exergy losses, second law efficiency and COP were investigated.

II. PROCESS DESCRIPTION AND SIMULATION

Marun C₂⁺ Recovery plant (CRP) Petrochemical Company is located south east of Ahwaz in south of Iran. The process consists of six main units: 1- Feed Inlet Facilities unit, 2- Feed Compression unit, 3- Drying unit, 4- C₂⁺ Recovery unit, 5- C₂⁺ Buffer, 6-Sales Gas Export. C₂⁺ product will be transferred to olefin petrochemical units

In CRP an external refrigeration cycle is used which is quite discrete from the process. Refrigeration cycle is shown in Fig.1. The purpose of the propane refrigerant system is to provide additional cooling for the plant in a temperature range below cooling water i.e. for recovering the C₂⁺ components from the Natural Gas feed. This refrigeration system has three stages. Additional power savings can be achieved by using a three-stage compression system. As with a two-stage system, flash economization and/or an intermediate heat load can be used. The savings, while not as dramatic as the two stages versus one-stage, can still be significant enough to justify the additional equipment. Energy consumption is frequently reduced as the number of stages is increased. The compression power for refrigeration can be reduced further by shifting refrigerant load from cooler levels to warmer levels.

The interstage pressure and corresponding refrigerant temperature may be fixed by either equipment or process conditions. Equal compression ratios per stage are chosen whenever possible to minimize work. Propane Refrigerant is provided to the consumer at the following temperature [1]:

- LP propane -38 °C
- MP propane -17 °C

The propane vapors are compressed by three-stage propane compressor C-4 which is driven by a variable speed electrical motor. The propane from the compressor discharge enters the propane condenser E-4 where is totally condensed against cooling water. The propane liquid enters in the Propane Buffer Drum D-12 and Subcooled in the Propane Subcooler E-3 against cooling water. Subsequently the liquid propane is expanded into the Suction Drum 3rd stage of compressor C-4. From the 3rd stage Suction Drum; D-7 the propane vapour is charged to the 3rd stage of compressor C-4. The liquid level in D-7 is controlled by feeding liquid propane from Propane Buffer Drum D-12. The purpose of establishing a liquid level in D-7 is to cool bypassed propane gas during bypass operation. The liquid propane from 3rd stage Suction Drum; D-7 is expanded into the 2nd Stage Suction Drum; D-8 of compressor C-4 and MP-Propane Circulation; D-9.

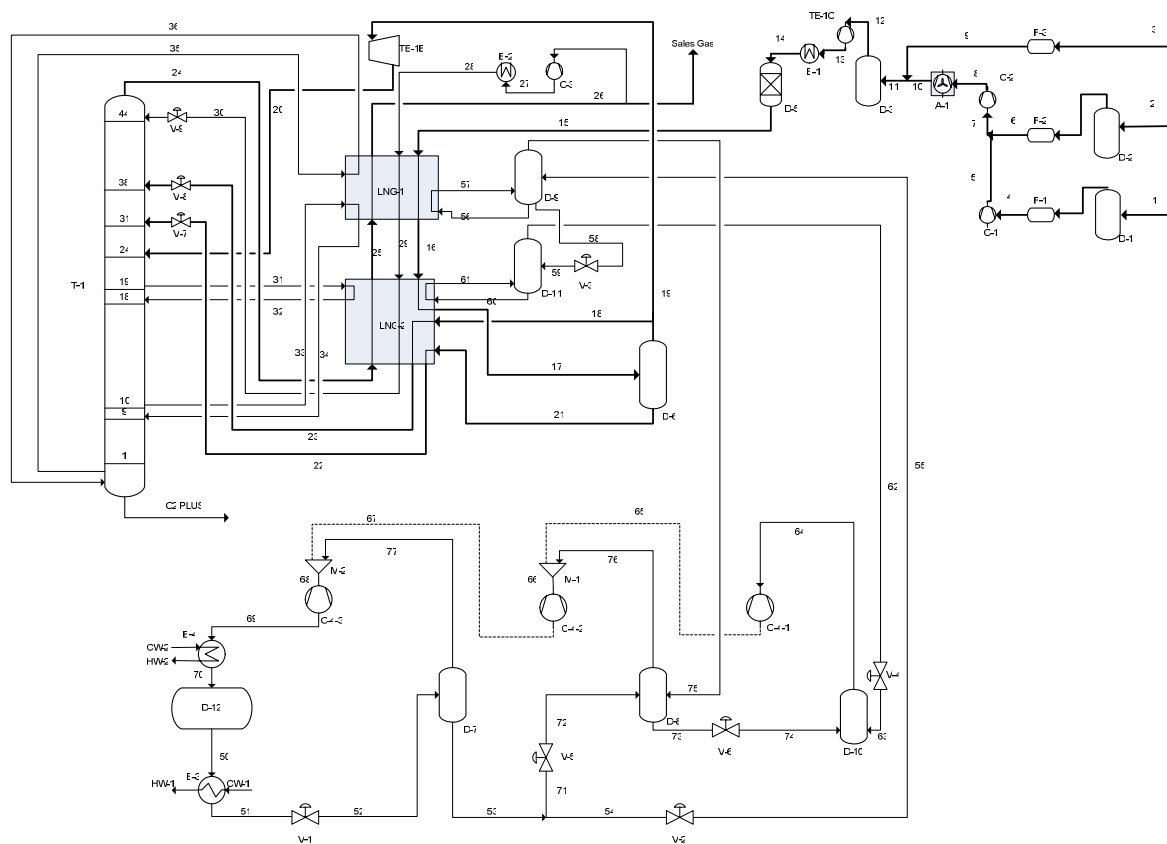

Fig.1. Propane refrigeration cycle used in C₂⁺ recovery plant (CRP).

The purpose of establishing a liquid level in D-8 is to cool bypassed propane gas during bypass operation. The purpose of establishing a liquid level in D-9 is to provide cooling in the Feed Gas Cooler I by means of natural circulation. The evaporated propane is routed back to D-8. From the D-8, propane vapor is charged to the 2nd stage of compression C-4. The liquid propane from D-9 is withdrawn at a temperature of -17 °C and fed into the LP-Propane Circulation Drum D-11. After expansion to approx. 1.2 bara it supplies cold propane at -38 °C to D-11. The purpose of establishing a liquid level in D-11 is to provide cooling in the Feed Gas Cooler II by natural circulation. The evaporated propane is routed to the 1st stage Suction Drum; D-10. A liquid level in D-10 is controlled by feeding liquid propane from D-8. The purpose of establishing a liquid level in D-10 is to cool bypassed propane gas during bypass operation. From the 1st stage suction drum, D-10 propane vapour is charged to the 1st stage of compressor C-4. The suction pressure of the 1st stage is controlled by adjusting the speed of the Propane Compressor in the first stage of compressor C-4. In the 1st stage of C-4 the propane is compressed from 1.08 to approx 2.5 bar. In the 2nd stage of C-4 the propane is compressed from 2.5 to approx 6.5 bar. In the 3rd stage of C-4 the propane is compressed from 6.5 to approx 16.6 bar.

III. EXERGY ANALYSIS

Exergy analysis combines the first and second laws of thermodynamics, and is a powerful tool for analyzing both the quantity and the quality of energy utilization. The maximum work obtainable from a system using the environmental parameters as reference state is called exergy and is expressible in terms of four components: physical exergy, kinetic exergy, potential exergy and chemical exergy. However, the kinetic and potential exergies are usually neglected and because there is no departure of chemical substances from the cycle to the environment, the chemical exergy is zero [6]. Therefore, in this analysis the physical exergy ($\dot{E}x$) is only considered and is calculated. Physical exergy of a material stream can be defined as the maximum work (useful energy) that can be obtained from when it is taken to physical equilibrium state (of temperature and pressure) with the environment:

$$\dot{E}x = (h - h_e) - T_e(s - s_e) \quad (1)$$

where h and s are the enthalpy and entropy respectively and T_e is the reference environmental temperature. Where the enthalpy and the entropy of the substance have to be evaluated at its temperature and pressure conditions (P, T) and at the temperature and pressure of the environment (P_e, T_e). When matter is taken from one state to another via a hypothetical reversible process, the reference terms cancel out and the change in exergy is given by:

$$\Delta \dot{E}x = (h_2 - h_1) - T_e(s_2 - s_1) \quad (2)$$

This change in exergy represents the minimum amount of work to be added or removed to change from state 1 to state 2 when there is an increase or decrease in internal energy or enthalpy resulting from the change.

Exergy balance and irreversibility: Considering the control volume at steady state (Fig.2) the exergy balance can be expressed as

$$\dot{E}x_{in} + \dot{E}x_{Qin} = \dot{E}x_{out} + \dot{E}x_{Qout} + \dot{W}_{shaft} + \dot{I} \quad (3)$$

The exergy analysis is mainly concerned for the calculation of exergy efficiency and lost work for each unit operation.

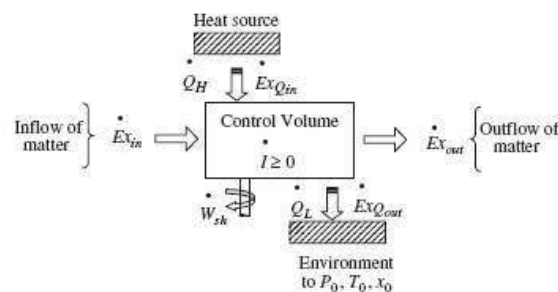

Fig. 2. Flow of matter and energy in a control region of a steady state process, adapted from Ref [6].

A. Exergy balance for cycle

The total exergy destruction in the cycle is simply the sum of exergy destructions in condensers, LNG and compressors. The overall exergetic efficiency of the cycle can be defined as:

$$\eta = \frac{\dot{E}x_{out} - \dot{E}x_{in}}{\dot{W}_{actual}} = 1 - \frac{\dot{I}_{total}}{\dot{W}_{actual}} \quad (4)$$

where given in the numerator is the exergy difference or the actual work input to the cycle \dot{W}_{actual} minus the total exergy destruction \dot{I}_{tot} . The actual work input to the cycle is the sum of the work inputs to the propane compressor. Total exergy destruction is sum of the all input stream that inlet to cycle components minus sum of the all input stream that leave cycle components.

The exergy of material and energy streams in refrigeration cycle has been calculated based on (1), where the HYSYS calculate the enthalpy and the entropy of each stream.

Lost work and exergetic efficiency for all compartments in refrigeration cycle can be listed, and then by comparison of both efficiency and lost work values it will be possible to find the sites of plant that operate in low performance of energy with a large amount of exergy losses. After finding these weak sites, we can suggest some practical ways like changing the process operation conditions or changing the components or configuration of system layout to decrease the irreversibilities and energy losses.

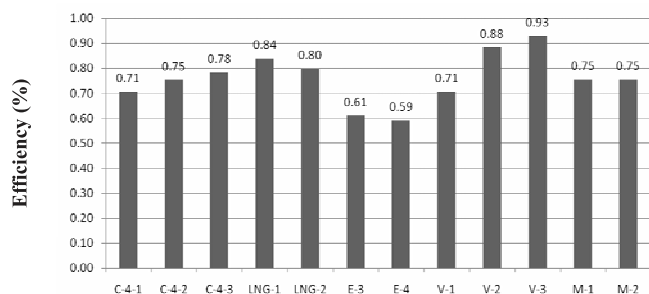

Fig. 3. Exergetic efficiencies of refrigeration cycle components.

After simulating the process via HYSYS; it is linked (automated) to MATLAB (computational) environment to evaluate the efficiency and lost work by changing in process. The reason for using MATLAB is that the simulation (HYSYS) model has been developed mainly for design purposes rather than for performance and exergy analysis, so by linking the HYSYS to an external package such as MATLAB we may carry out the computations more efficiently. We can also provide optimization programs or optimization packages (like MATLAB optimization toolboxes) linked to our process simulation file. The results for all components except Flash Drums are summarized in Figs 3 and 4. The exergy efficiency and lost work for cycle have been calculated 39.90% and 6.02×10^3 (kw), respectively.

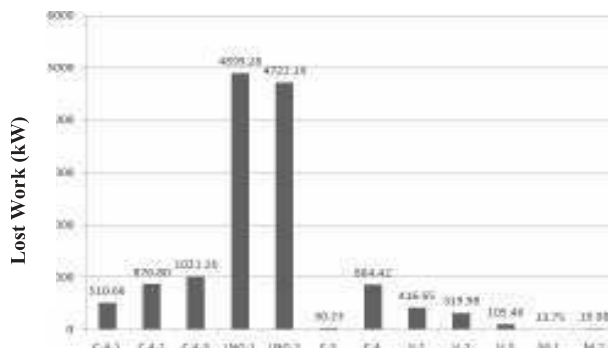

Fig. 4. Lost work of refrigeration cycle components.

IV. RESULTS AND DISCUSSION

Coefficient of performance (COP)

The performance of refrigerators and heat pumps is expressed in terms of *coefficient of performance* (COP). COP is a standard criterion for performance analysis of a refrigeration cycle or heat pump. For real one-stage cycles used in gas industries it usually gets value from 0.85 to 4. The COP is the ratio of total removed heat from evaporator divided by required total input work in compression section. All the removed heat from evaporator section (Q_{ev}) and required input works for compressor are summarized in Table 1. For instance, we may calculate the COP of the cycle as:

$$COP_{actual} = \frac{\sum_{i=1}^n Q_{Li}}{\sum_{j=1}^m W_j} = \frac{18530}{10016} = 1.85 \quad (5)$$

where n is the number of evaporators, and m is denoted as number or stages of compressors. A refrigerator or heat pump that operates on the reversed Carnot cycle is called a *Carnot refrigerator* or a *Carnot heat pump*, and their COPs are ideal. For the ideal case, COP is obtained as 2.4 :

$$COP_{ideal} = \frac{1}{\left(\frac{T_H}{T_c} - 1\right)} = \frac{1}{0.417} = 2.4 \quad (6)$$

So, by decreasing the irreversibilities or changing the type of refrigeration cycle or its configuration (for example changing from one stage to multi stage cycles), it is possible to increase the performance of coefficient (COP).

TABLE 1 SIMULATION RESULTS FOR COP CALCULATION

Compressor no.	Consumed work (kw)	Evaporator no.	Removed heat (kw)
C-4-1	1736	LNG-1	12162
C-4-1	3562	LNG-2	6368
C-4-1	4718	-	-

Exergy & COP Analysis

The exergy analysis of refrigeration cycle was carried out in the present study to evaluate the magnitude of exergetic losses in each component of the refrigeration system. The lowest efficiencies belong to exchanger E-4 (59%) and exchanger E-3 (61%), therefore the large amount of irreversibility belongs to condenser and expansion sections. Evaporating section has the highest amount of efficiency as 80% so Evaporator performance is the nearest to ideal manner.

The product flow rate (C_2^+) is a function of evaporator's temperature and it will be increased as the evaporator's heat rejection is decreased. Propane refrigerant temperature is very sensitive to its pressure. The pressure drop in chillers of the cycle is the basic parameter. The refrigerant temperature is decreased as its pressure decreased. This low temperature propane obtains the cooling load in the chillers, more pressure drop in the evaporation section more temperature reduction is caused; in the other hand changing in pressure drop affect the evaporator's temperature. When the pressure drop in evaporators is increased more work will be consumed in compression section therefore pressure drop is an important parameter that it can affect the energy consumption in the cycle and its performance. Also it has a strong effect on C_2^+ production in the unit.

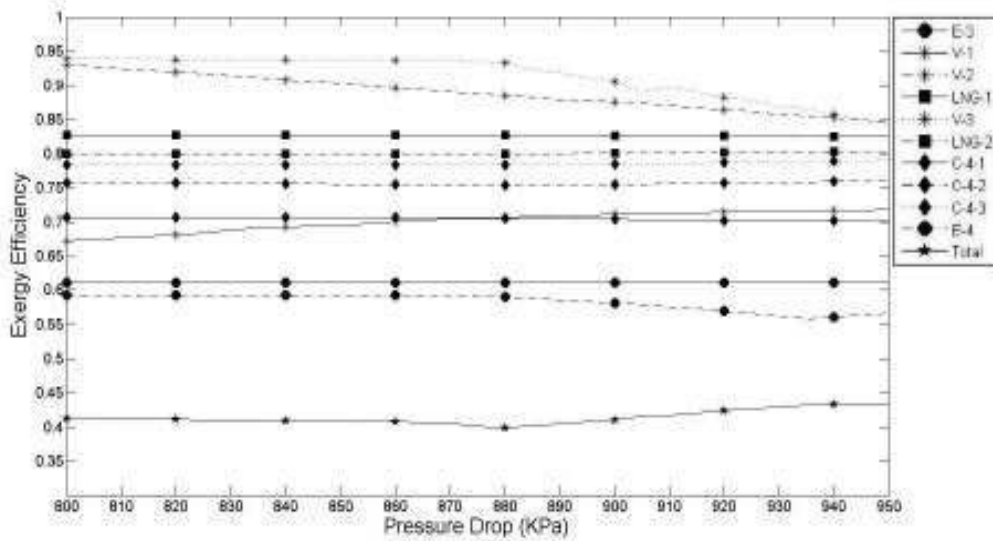

Fig. 5. Variation of Exergy Efficiency in each component with the change in V-1 pressure drop.

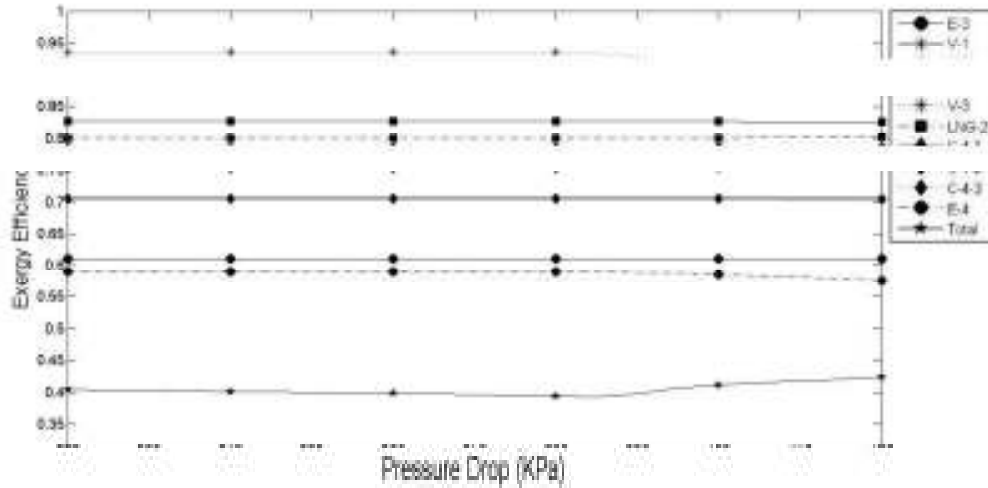

Fig. 6. Variation of Exergy Efficiency in each component with the change in V-2 pressure drop.

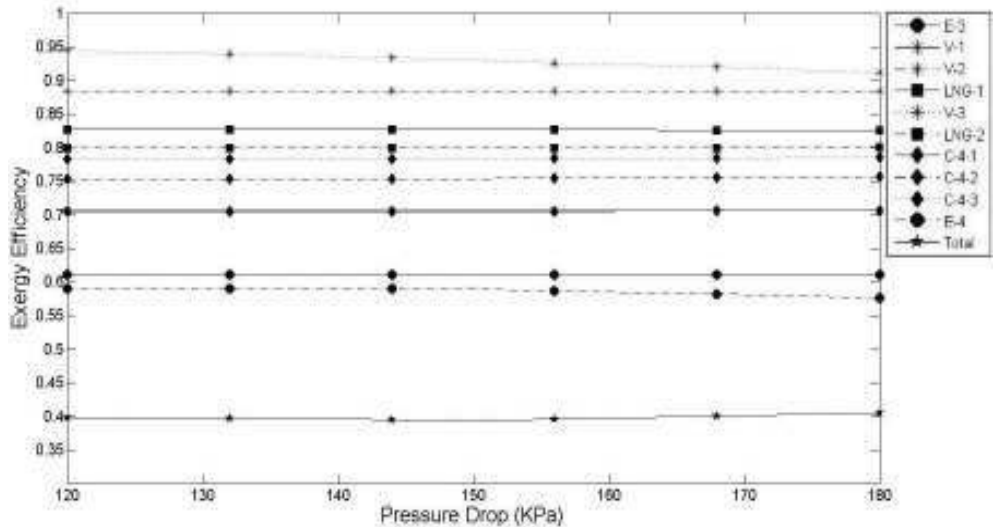

Fig. 7. Variation of Exergy Efficiency in each component with the change in V-3 pressure drop.

Exergy efficiency in each compartment, the COP and second law efficiency of the cycle are calculated by an iterative scheme. Average values of properties at the inlet and outlet of the condenser and Valves are used in these calculations. Figs 5–7 show the exergy efficiency in each component and total exergy efficiency versus V-1 pressure drop, V-2 pressure drop, and V-3 pressure drop, respectively. Figs 8–10, show the COP, removed heat from evaporator and compressor efficiency over the above parameters.

As shown in Fig.7, the variation of the Exergy Efficiency in each component and in the cycle is plotted against the change in V-1 pressure drop. It can be seen that when Pressure drop increases, the V-1 Exergy Efficiency increases whereas the V-2 Exergy Efficiency decreases. The V-3, E-4 Exergy Efficiency and Total Exergy Efficiency are constant (up to a value of 880 Kpa). Afterward, the V-3 and E-4 Exergy Efficiency decreases and Total Exergy Efficiency value increases slightly. Fig.8 illustrates the relationship between the COP and the V-1 pressure drop. As shown in Fig.8, the COP value, compressor work and removed heat of evaporators are constant (up to a value of 880 Kpa). Next, because of decreasing the removed heat from evaporators and increasing the compressor work, the COP value decreases. By increasing pressure drop the amount of vapour in D-7 increases, therefore the more vapour is charged to the 3rd stage of C-4, consequently the work of this stage is increased. But the liquid propane from the Suction Drum D-7 decreases therefore the works of other stage of compressor decreases then the sum of the works up to 880 kpa is constant. Even though the liquid propane from the D-7 decreases but the temperature of propane decreases then it supplies the removed heat of evaporators and it is constant nearly up to 880 Kpa pressure drop. In spite of this, when the pressure drop increases above the 880 kpa, the liquid propane is a little that it cannot supplies the required removed heat of evaporator and the compressor work increases. So the COP value increases. This reason can be true for the trend of E-4 and V-3 exergy efficiency.

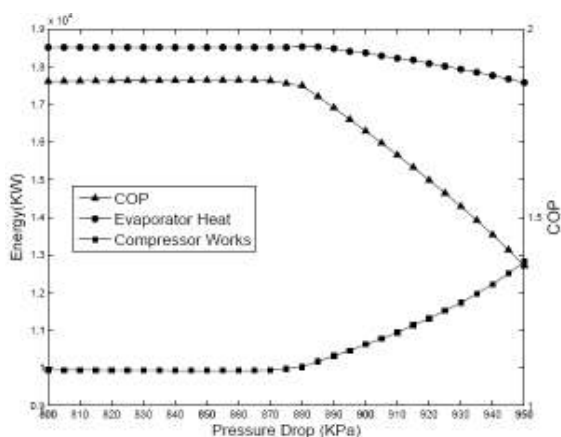

Fig. 8. Variation of COP and Evaporator Heat and Compressor Works (kW) with the change in V-1 Pressure Drop.

As can be seen in Fig.6, the variation of the Exergy Efficiency in each component and in the cycle is plotted

against the V-2 pressure drop. It is seen that when Pressure drop increases, the V-2 Exergy Efficiency decreases. The V-3 and E-4 Exergy Efficiency and Total Exergy Efficiency value is constant (up to a value of 880 Kpa). Afterward, the V-3 and E-4 Exergy Efficiency decreases and Total Exergy Efficiency value increases. Fig.9 shows the relationship between the COP and the V-2 pressure drop. The reason of such trend is like the analysis which quoted for V-1 pressure drop trend.

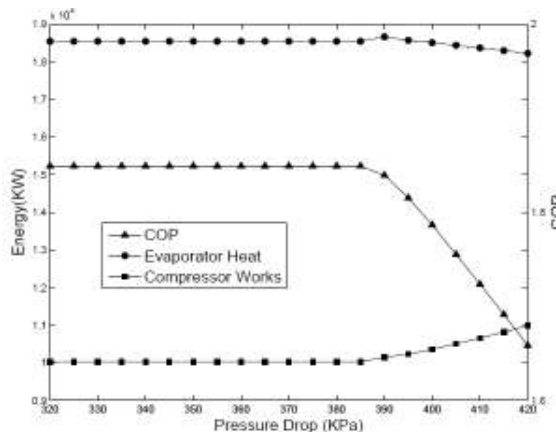

Fig. 9. Variation of COP and Evaporator Heat and Compressor Works (kW) with the change in V-2 Pressure Drop.

Fig.7 illustrates the variation of the Exergy Efficiency in each component and in the cycle against the change in V-3 pressure drop. It is seen that when Pressure drop increases, the V-3 Exergy Efficiency decreases. The E-4 Exergy Efficiency and Total Exergy Efficiency value is constant (up to a value of 880 kpa). Afterward, the E-4 Exergy Efficiency decreases and Total Exergy Efficiency value increases. Fig.10 shows the relationship between the COP and the V-3 pressure drop. The reason of such trend is like the analysis which quoted for V-1 and V-2 pressure drop.

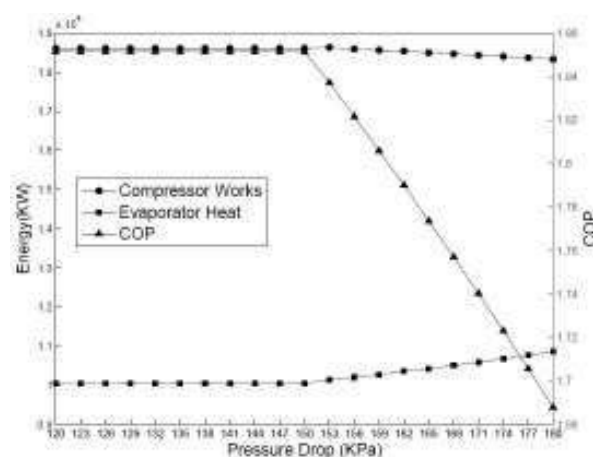

Fig.10. Variation of COP and Evaporator Heat and Compressor Works (kW) with the change in V-3 Pressure Drop.

V. CONCLUSIONS

This paper presents the methods and results of applying exergy analysis in a typical, large scale and industrial ethane recovery plant, the so-called CRP process. The exergy method used here is found to be a powerful and systematic tool in optimizing the performance of such complex refrigeration systems. The main concern has been focused on its refrigeration cycle. The equations of exergy destruction and exergetic efficiency for the main cycle components such as evaporators, condensers, compressors, and expansion valves are developed. Before conducting the exergy analysis, a rigorous process simulation is needed to be accomplished by a conventional process simulator such as HYSYS. The whole plant was simulated via HYSYS and was promoted by automation link to the MATLAB environment. The link is necessary for exergy calculations. The exergy analysis results on the refrigeration cycle indicate that the condenser and valves sections have the highest irreversibility. Also, the evaporator's irreversibility is acceptable. Because the plate-fin heat exchanger is used instead of other conventional heat exchangers and exergy efficiency is much higher than other such heat exchangers. Exergetic efficiency is calculated for each component of refrigeration cycle. Refrigeration cycle of CRP (case study) was also analyzed by T-S diagram and COP was obtained as 1.85 for actual case.

The complex nature of C_2^+ recovery plants caused process variables are known as determining factors in design and performance of such plants. We select a currently in operation C_2^+ recovery plant as case study.

The performance of propane refrigeration cycles in these plants can be affected by some process parameters. In this work we tried to show that expansion valves pressure drop, are effective parameters. They can affect the refrigeration cycle components efficiency as shown in the figures. Also by adjusting these variables the cycle efficiency and consequently process performance can be improved. To that end, it can be said that the integration between the cycle and the process determine how above said parameter should be tuned.

REFERENCES

- [1] Vidal A, Best R, Rivero R, Cervantes J, Analysis of a combined power and refrigeration cycle by the exergy method, *Energy* 31 (2006) 3401–3414.
- [2] Kotas T.J. The exergy method of thermal plant analysis. Malabar, FL: Krieger Publish Company; 1995.
- [3] Kanoglu M, Exergy analysis of multistage cascade refrigeration cycle used for natural gas liquefaction, *Int. J. Energy Res* 26. (2002), 763–774
- [4] GPSA. 1998. Section 16, Hydrocarbon Recovery (11th ed). Gas Processors Suppliers Association. SI Version.
- [5] E Van Wylen and Sonntag, *Fundamentals of Classical Thermodynamics*, (6th ed), John Wiley & Sons ,(2002)
- [6] Khaliq A, Kumar R, Exergy analysis of double effect vapor absorption refrigeration system, *Int. J. Energy Res* 32, 2008, 161–174
- [7] Mehrpooya M, Jarrahan A, Pishvaie M.R, Simulation and exergy-method analysis of an industrial refrigeration cycle used in NGL recovery units, *Int. J. Energy Res* 30. (2006), 1336–1351
- [8] Mehrpooya M, Gharagheizi F, vatani A, An Optimization of Capital and Operating Alternatives in a NGL Recovery Unit, *Chem. Eng. Technol.* 29 (No.12), (2006) , 1469–1480
- [9] Smith E.M, *Advances in Thermal Design of Heat Exchangers*, 2005 John Wiley & Sons, Ltd, 2005
- [10] Bhattacharyya S, Bose S, Sarkar J, Exergy maximization of cascade refrigeration cycles and its numerical verification for a transcritical CO₂-C₃H₈ system, *International Journal of Refrigeration* 30 (2007) 624–632.
- [11] Tozer R, James R.W, Heat powered refrigeration cycles, *Applied Thermal Engineering* 18 (1998) 731–743.
- [12] Zhang N, Lior N, Methodology for thermal design of novel combined refrigeration/power binary fluid systems, *International Journal of Refrigeration* 30 (2007) 1072–1085.
- [13] Bejan A. *Advanced Engineering Thermodynamics*. John Wiley & Sons New York.1988.
- [14] Gaggioli RA. 1998. Available energy and exergy. *International Journal of Applied Thermodynamics* 1(1–4):1–8.
- [15] Moran MJ. *Availability Analysis: A Guide to Efficient Energy Use*. Prentice-Hall: Englewood Cliffs, NJ. 1982
- [16] Nikolaidis C, Probert D. Exergy-method analysis of a two-stage vapour-compression refrigeration-plants performance. *Applied Energy* 60, (1998), 241–256.
- [17] Talbi M.M, Agnew B, Exergy analysis: an absorption refrigerator using lithium bromide and water as the working fluids, *Applied Thermal Engineering* 20 (2000) 619–630.
- [18] Zheng J, Sun F, Chen L, Wu ch, Exergy analysis for a Braysson cycle, *Exergy Int. J.* 1(1) (2001) 41–45
- [19] Yumrutas, R, Kunduz M, Kanoglu M. Exergy analysis of vapor compression refrigeration systems. *Exergy, an International Journal* 2, (2002), 266–272.
- [20] Ouadha A, En-nacer M, Adjlout L, Imine O. Exergy analysis of a two-stage refrigeration cycle using two natural substitutes of HCFC22. *International Journal of Exergy* 2(1), (2005),14–30.
- [21] Stegou-Sagia A, Paigniannis L. Exergy losses in refrigerating systems. A study for performance comparisons in compressor and condenser. *International Journal of Energy Research* 27, (2003), 1067–1078.