

Developing a Simple and an Accurate Formula for the Conduction Angle of a Single Phase Rectifier with RL Load

S. Ali Al-Mawsawi, Fadhel A. Albasri

Abstract—The paper presents a simple and an accurate formula that has been developed for the conduction angle (δ) of a single phase half-wave or full-wave controlled rectifier with RL load. This formula can be also used for calculating the conduction angle (δ) in case of A.C. voltage regulator with inductive load under discontinuous current mode. The simulation results shows that the conduction angle calculated from the developed formula agree very well with that obtained from the exact solution arrived from the iterative method. Applying the developed formula can reduce the computational time and reduce the time for manual classroom calculation. In addition, the proposed formula is attractive for real time implementations.

Keywords—Conduction Angle, Firing Angle, Excitation Angle, Load Angle.

I. INTRODUCTION

INDUSTRIAL load typically contain inductance as well as resistance. An inductor in series with the load will serve as a filter representing a high filter impedance to the alternating harmonic components in the rectifier output. The inductor may also be considered as storing magnetic energy when the current is above the average value and releasing that energy to the load when the current tends to fall below the average, thus reducing the ripple. In power electronics applications, it is often necessary to consider a load consisting of a resistive load in series with an inductive load. Consider this type of a load with a single phase phase-angle controlled voltage regulator as shown in figure 1. By adding an inductor in series with the load resistance causes an increase in the conduction period of the load current, hence resulting the regulator circuit working under an inductive load [1]-[13].

The waveform of the output voltage (v_o) and the output current (i_o) are represented in Fig. 2.

S. A. Al-Mawsawi is with the Department of Electrical & Electronics Engineering, College of Engineering, University of Bahrain, P.O. Box 32038, Kingdom of Bahrain. (email: salmosawi@eng.uob.bh)

F. A. Albasri is with the Department of Electrical & Electronics Engineering, College of Engineering, University of Bahrain, P.O. Box 32038, Kingdom of Bahrain. (email: albasri@eng.uob.bh)

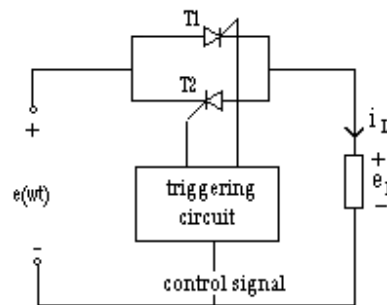

Fig. 1 A single phase phase-angle controlled voltage regulator with RL load.

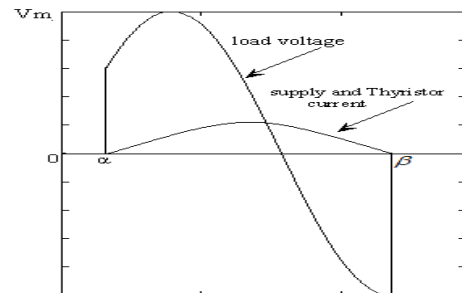

Fig. 2 waveform of output voltage and output current of Fig. 1.

For the input voltage, $V_{in} = V_m \sin(\omega t)$, the circuit differential equation for the conducting interval and neglecting the voltage drop across the thyristor can be written as:

$$V_m \sin(\omega t) = i_0(t)R + L \frac{di_0(t)}{dt} \quad (1)$$

Let α be the firing angle of the thyristor, ($0 < \alpha < 180^\circ$) and ϕ be the load angle,

$$\phi = \tan^{-1} \frac{\omega L}{R}$$

Where, ($0^\circ < \phi < 90^\circ$).

Solving equation (1) using the differential equation for $\alpha > \phi$, the following equation for the load current can be obtained [1]-[3]:

$$i_0(t) = \frac{V_m}{|Z|} \sin(\omega t - \phi) - \frac{V_m}{|Z|} \sin(\alpha - \phi) e^{-\frac{R}{\omega L}(\omega t - \alpha)} \quad (2)$$

Where
 $|Z|$ is the magnitude of the load impedance $|Z| = \sqrt{R^2 + (\omega L)^2}$
 and V_m is a supply peak voltage.

It is well known that equation (2) is also valid for the case of a single phase full wave rectifier and A.C. single phase regulator with RL load under discontinuous current mode of operation when $\alpha > \phi$ [1]-[13].

From figure (2) it can be seen that the current is existing between the firing angle (α) and excitation angle (β). Nevertheless, in order to calculate the performance parameters of the circuit it is necessary to know the value of excitation angle (β). Accordingly, β can be found from the solution of equation (2) when $i_o(t) = 0$ at $\omega t = \beta$:

$$\sin(\beta - \phi) - \sin(\alpha - \phi) e^{-\frac{R}{\omega L}(\beta - \alpha)} = 0 \quad (3)$$

Hence, the conduction angle (δ) is defined as the period at which the power electronic device is conducting:

$$\delta = (\beta - \alpha) \quad (4)$$

Therefore, substituting (4) into (3) to get equation in term of δ and α :

$$\sin(\delta + \alpha - \phi) - \sin(\alpha - \phi) e^{-\frac{R}{\omega L}(\delta)} = 0 \quad (5)$$

Therefore, equation (5) is not linear and the iteration needed for solving for (δ) which is time consuming. A family of curves for calculating the conduction angle (δ) can be used to overcome this difficulty [4]-[5]. However these curves are not providing all possible values of (ϕ) and are not being easily usable in direct computations. Therefore, the objective of this paper is to develop a simple and accurate close-form formula for calculating the conduction angle (δ) of equation (5) under discontinuous conduction mode.

II. FORMULA DEVELOPMENT METHOD

In general, the conduction angle (δ) for purely inductive load, $\phi = 90^\circ$, can be found from:

$$\delta_{(\phi=90^\circ)} = 2(\pi - \alpha) \quad (6)$$

Whereas, the conduction angle (δ) for resistive load, $\phi = 0^\circ$, can be found from:

$$\delta_{(\phi=0^\circ)} = (\pi - \alpha) \quad (7)$$

Consequently, it can be seen from equations (6) and (7) that all the condition characteristics lie between two linear boundaries in the (δ) versus (α) plane. It is proposed that an

approximate value of conduction angle (δ) can be found from the simple relationship [13]:

$$\Delta = \pi + \phi - \alpha \quad (8)$$

Where, the range of change of Δ for different load resistance is given in Table 1:

TABLE I
 RANGE OF CHANGE Δ FOR DIFFERENT LOAD RESISTANCE

Δ in degree		Load resistance(R)
From	to	
5 ⁰	10 ⁰	> ωL
10 ⁰	15 ⁰	$\approx \omega L$
15 ⁰	20 ⁰	< ωL

Using equation (8) with the possible values of Δ and by using tools provided by Matlab program called Curve Fitting [14]-[15], the following formula has been obtained:

$$\delta = \phi(0.047\phi + 1.64) - \alpha(0.04\alpha + 0.8) - 0.565\phi\alpha + 2.988 \quad (9)$$

III. SIMULATION RESULTS

To verify the validity of the obtained formula, the exact values of the conduction angle (δ) are computed from non-linear equation (5), by using a Newton-Rapason iteration method and compared with that proposed formula given in equation (9). The values of the conduction angle are computed from both equations (5) and (9), for different values of load angles ($\phi = 5^\circ, 25^\circ, 55^\circ, 75^\circ$) as shown in Fig. 3 to Fig. 6. It can be seen from these figures that the proposed formula simulates the conduction angle with a reasonable accuracy. Furthermore, it has been observed that the percentage error is minimum (<1%) in most cases of load angle. However, the maximum percentage of error of less than 5% can be obtained at highly inductive load. In other words, further fine tuning of the developed formula can reduce this error.

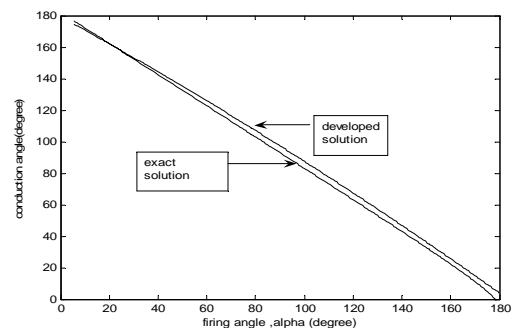

Fig. 3 Variation of firing angle (α) with conduction angle (δ) in case of $\phi = 5^\circ$

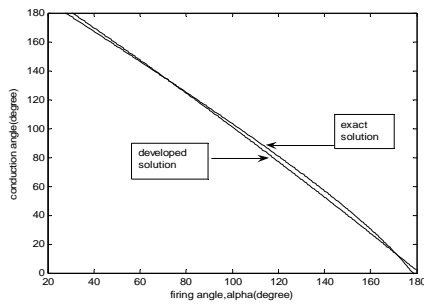

Fig. 4 Variation of firing angle (α) with conduction angle (δ) in case of $\phi = 25^\circ$

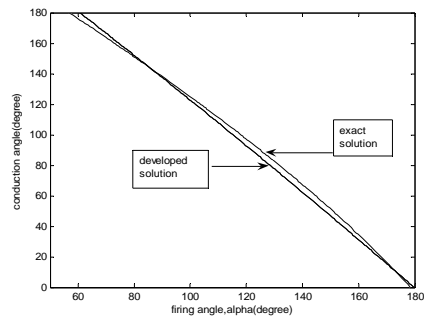

Fig. 5 Variation of firing angle (α) with conduction angle (δ) in case of $\phi = 55^\circ$

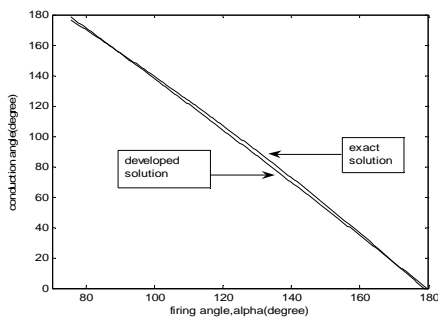

Fig. 6 Variation of firing angle (α) with conduction angle (δ) in case of $\phi = 75^\circ$

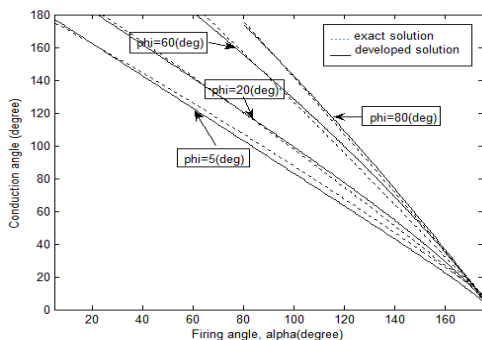

Fig. 7 Variation of firing angle (α) with conduction angle (δ) for difference cases of load angle (ϕ)

IV. APPLICATIONS OF PROPOSED FORMULA

There has been some work done in literature to simplify the conduction angle. For example, in [16], the following formula was proposed for excitation angle (β).

$$\beta = \pi(\pi - \alpha) \sqrt{\frac{(\pi - \alpha)(1.14 - 0.045 \tan^2 \phi) + 5 \tan \phi}{12(\tan \phi + \pi - \alpha)}} \quad (10)$$

It was claimed that the overall error of the above formula is less than 3% for any value of load impedance and firing angle when compared with the exact iterative solution obtained from solving the non-linear equation (3) using Newton-Raphson method [16]. Although the formula given in (10) is simple as compared to the non-linear equation of (3), it is not as simple as our proposed formula given in (9). In addition, the developed simple formula given in equation (9) is more attractive for real time implementation in hardware because only multiplications and addition operations are required as compared to complexity of implementing equation (10). Furthermore, the proposed formula can be used as a teaching tool in classroom to reduce the computational time.

V. CONCLUSION

The development of a simple and an accurate formula for the conduction angle (δ) of a single phase half-wave or full-wave controlled rectifier with RL load has been presented. This formula can be also used for calculating the conduction angle (δ) in case of A.C. voltage regulator with inductance load under discontinuous current mode. It has been shown that the results calculated from the developed formula agree very well with that obtained from the exact iterative method. The maximum percentage of error was obtained at highly inductive load and was less than 5%. The developed simple formula can be used to reduce the computational time and provides a close form solution that students can use in classroom for manual calculation and analysis. In addition, the proposed formula is attractive for real time implementations.

REFERENCES

- [1] M.H. Rashid, "Power Electronics: Circuit, Devices, and Applications", Third edition, Pearson Prentice Hall, USA, 2004.
- [2] D. W. Hart, "Introduction to Power Electronics", Prentice Hall, USA, 1997.
- [3] B.M. Bird and K.G. King, "An Introduction to Power Electronics", John Wiley & Sons Ltd, January 1988.
- [4] N. Mohan, T. Undeland, and W. Robbins, "Power Electronics: Converters, Applications, and Design", Third Edition, John Wiley & Sons, USA, 2003.
- [5] A. Ahmed, "Power Electronics for Technology", Prentice Hall, USA, 1999.
- [6] P.C. Sen, "Power Electronics", Tata McGraw-Hill Publishing Company Limited, New Delhi, 1990.
- [7] J. Kassakian, M. Schlecht, and G. Verghese, "Principles of Power Electronics", Addison-Wesley Publishing Company, New York, 1991.
- [8] C.W. Lander, "Power Electronics", Second Edition, McGraw-Hill Book Company, U.K., 1987.
- [9] D. Straughen, "Power Semiconductor Circuits", Wiley-Interscience Publication, John Wiley & Sons, New York, 1975.

- [10] M.J. Fisher, "Power Electronics", Thomson Information / Publishing group, PWS-KENT Publishing Company, Boston, 1991.
- [11] S.K. Datta, "Power Electronics & Controls", Prentice-Hall Company, Reston, Virginia, 1985.
- [12] W. Shepherd and L.N. Hulley, "Power Electronics and Motor Control", Cambridge University Press, U.K., 1982.
- [13] 13 - B.R. Pelly, Thyristor Phase -Control Converters and Cycloconverters, John Wiley & Sons, Inc, Canada, 1971.
- [14] 14- A.Brain and M .Breiner, MATLAB for Engineering , Addison-Weseley, Workingham ,1995.
- [15] 15-D.Fowoy, and M. Horton , The Student edition of MATLAB, The Math Works, London, 1995.
- [16] 16- M. Akbaba, S. Nassimi, and I. Qamber, "Accurate formula for the conduction angle of single phase voltage controllers and controlled rectifiers with inductive loads", Modelling, Measurement & Control, Vol. 59, No. 3, 1995, pp. 41-46.