

Artificial Neural Networks Application to Improve Shunt Active Power Filter

Rachid.Dehini, Abdesselam.Bassou, Brahim.Ferdi

Abstract—Active Power Filters (APFs) are today the most widely used systems to eliminate harmonics compensate power factor and correct unbalanced problems in industrial power plants. We propose to improve the performances of conventional APFs by using artificial neural networks (ANNs) for harmonics estimation. This new method combines both the strategies for extracting the three-phase reference currents for active power filters and DC link voltage control method. The ANNs learning capabilities to adaptively choose the power system parameters for both to compute the reference currents and to recharge the capacitor value requested by VDC voltage in order to ensure suitable transit of powers to supply the inverter. To investigate the performance of this identification method, the study has been accomplished using simulation with the MATLAB Simulink Power System Toolbox. The simulation study results of the new (SAPF) identification technique compared to other similar methods are found quite satisfactory by assuring good filtering characteristics and high system stability.

Keywords—Artificial Neural Networks (ANN), p-q theory, (SAPF), Harmonics, Total Harmonic Distortion.

I. INTRODUCTION

DUE to proliferation of power electronic equipment and nonlinear loads in power distribution systems, the problem of harmonic contamination and treatment take on great significance. These harmonics interfere with sensitive electronic equipment and cause undesired power losses in electrical equipment [1-8]. In order to solve and to regulate the permanent power quality problem introduced by this Current harmonics generated by nonlinear loads such as switching power factor correction converter, converter for variable speed AC motor drives and HVDC systems, the passive filters have been used; which are simple and low cost. However, the use of passive filter has many disadvantages, such as large size, tuning and risk of resonance problems.

Lately, owing to the rapid improvement in power semiconductor device technology that makes high-speed, high-power switching devices such as power MOSFETs, MCTs, IGBTs, IGCTs, IEGTs etc. usable for the harmonic

compensation modern power electronic technology, Active power filter (APF) have been considered as an effective solution for this issue, it has been widely used.

One of the most popular active filters is the Shunt Active Power Filter (SAPF) [2-6, 8]. SAPF have been researched and developed, that they have gradually been recognized as a workable solution to the problems created by non-linear loads. The functioning of shunt active filter is to sense the load currents and extracts the harmonic component of the load

current to produce a reference current i_c^* , a block diagram of the system is illustrated in Fig. 1. The reference current consists of the harmonic components of the load current which the active filter must supply. This reference current is fed through a controller and then the switching signal is generated to switch the power switching devices of the active filter such that the active filter will indeed produce the harmonics required by the load. Finally, the AC supply will only need to provide the fundamental component for the load, resulting in a low harmonic sinusoidal supply.

Generally, the effectiveness of (SAPF) depends on three design criteria: (i) design of power inverter; (ii) use of current controller's types (iii) methods used to obtain the reference current. The presented work was oriented mostly on the latter criterion.

In order to determine harmonic and reactive component of load current, reference source current generation is needed. Thus, reference filter current can be obtained when it is subtracted from total load current. For better filter performance, generation of reference source current should be done properly. For this purpose, several methods such as pq-theory, dq-transformation, multiplication with sine function and Fourier transform have been introduced in literature [9-14].

Recently, some methods based on artificial intelligence have been applied. In order to improve processing detecting time of harmonic current. The past decade has seen a dramatic increase in interest Artificial Neural Networks (ANNs) which is characterized by its learning ability and high speed recognition but simple structure, the (ANNs) have been applied in many uses in the power electronic part of both machinery [16] and filters devices [17-24] where it have justified their effectiveness. The results obtained with ANNs are often better than those of traditional methods. Indeed, as a result of their capacities to optimize simultaneously their weights and biases in an on-line training process, they are able

Rachid.Dehini is with Department of the sciences and technology, Bechar University.A, B.P 417 BECHAR (08000), ALGERIA (corresponding author to provide phone: + 213-049-81-95-91; e-mail: dehini.rachid@yahoo.fr).

Abdesselam.Bassou is with Department of the sciences and technology, Bechar University.A, B.P 417 BECHAR (08000), ALGERIA Tel: + 213-049-90-24, Fax: +049-81-52-44 (e-mail: bassou2004@yahoo.fr).

Brahim.Ferdi is with Department of Electrical & Computer Engineering, Oran University of the sciences and technology, Oran, ALGERIA (e-mail: ferdi_brahim@yahoo.com).

to adapt themselves to any system.

In this paper, a detection method using artificial neural network (ANN) is presented which can be utilized in both harmonic current detection from distorted wave and DC link control voltage. This method can precisely obtain the reference current of each phase. The learning rate can be regulated in a wide range with little affection on the performance with a simple structure and theory [17-24]. The performances of the Neural Method are evaluated under simulation and are compared with p-q theory.

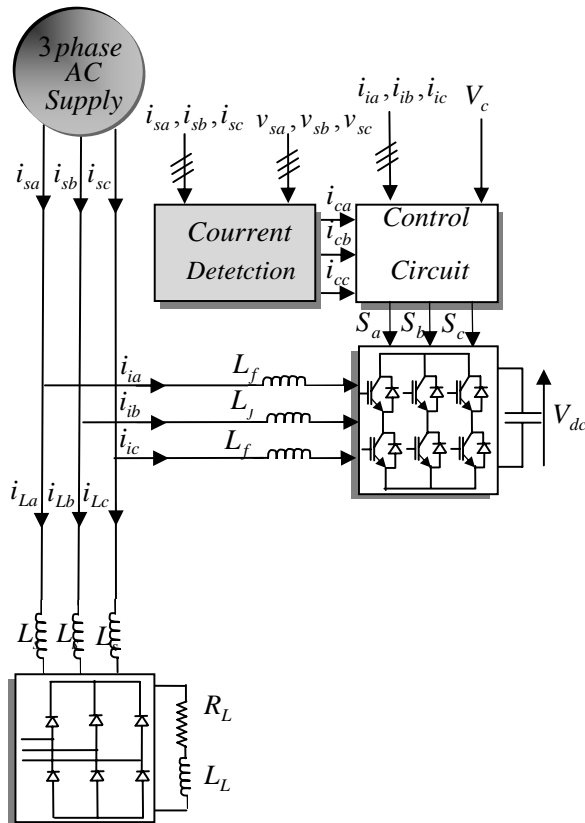

Fig.1. Schematic diagram of shunt APF

II. REFERENCE SOURCE CURRENT GENERATION

The concept of instantaneous reactive power theory (p-q theory) method basically consists of a variable transformation from the a, b, c reference frame of the instantaneous power, voltage and current signals to the $\alpha - \beta$ reference frame [13]. The instantaneous values of voltages and currents in the $\alpha - \beta$ coordinates can be obtained from the following equations:

$$\begin{bmatrix} v_\alpha \\ v_\beta \end{bmatrix} = [A] \begin{bmatrix} v_a \\ v_b \\ v_c \end{bmatrix}, \begin{bmatrix} i_\alpha \\ i_\beta \end{bmatrix} = [A] \begin{bmatrix} i_a \\ i_b \\ i_c \end{bmatrix} \quad (1)$$

where A is the transformation matrix and is equal to:

$$[A] = \begin{bmatrix} 1 & -1/2 & -1/2 \\ 0 & \sqrt{3}/2 & -\sqrt{3}/2 \end{bmatrix} \quad (2)$$

This transformation is valid if and only if $v_a(t) + v_b(t) + v_c(t) = 0$ and also if the voltages are balanced and sinusoidal. The instantaneous active and reactive powers in the $\alpha - \beta$ coordinates are calculated with the following expressions:

$$p(t) = v_\alpha(t) i_\alpha(t) + v_\beta(t) i_\beta(t) \quad (3)$$

$$q(t) = -v_\alpha(t) i_\beta(t) + v_\beta(t) i_\alpha(t) \quad (4)$$

The values of p and q can be expressed from Eqs.(3) and (4) in terms of the dc components plus the ac components, that is:

$$p = \bar{p} + \tilde{p} \quad (5)$$

$$q = \bar{q} + \tilde{q} \quad (6)$$

where:

\bar{p} : is the dc component of the instantaneous power p, and is related to the conventional fundamental active current.

\tilde{p} : is the ac component of the instantaneous power p, it does not have average value, and is related to the harmonic currents caused by the ac component of the instantaneous real power.

\bar{q} : is the dc component of the imaginary instantaneous power q, and is related to the reactive power generated by the fundamental components of voltages and currents.

\tilde{q} : is the ac component of the instantaneous imaginary power q, and is related to the harmonic currents caused by the ac component of instantaneous reactive power.

In order to compensate reactive power and current harmonics generated by nonlinear loads, the reference signal of the shunt active power filter must include the values of \bar{p} and \tilde{q} . [5] In this case the reference currents required by the SAPF are calculated with the following expression:

$$\begin{bmatrix} i_{c\alpha}^* \\ i_{c\beta}^* \end{bmatrix} = \frac{1}{v_\alpha^2 + v_\beta^2} \begin{bmatrix} v_\alpha & v_\beta \\ v_\beta & -v_\alpha \end{bmatrix} \begin{bmatrix} \tilde{P}_L \\ \tilde{Q}_L \end{bmatrix} \quad (7)$$

$$\begin{bmatrix} i_{ca}^* \\ i_{cb}^* \\ i_{cc}^* \end{bmatrix} = \sqrt{\frac{2}{3}} \begin{bmatrix} 1 & 0 \\ -\frac{1}{2} & \frac{\sqrt{3}}{2} \\ -\frac{1}{2} & -\frac{\sqrt{3}}{2} \end{bmatrix} \begin{bmatrix} i_{c\alpha}^* \\ i_{c\beta}^* \end{bmatrix} \quad (8)$$

The final compensating currents components in a, b, c reference frame are the following:

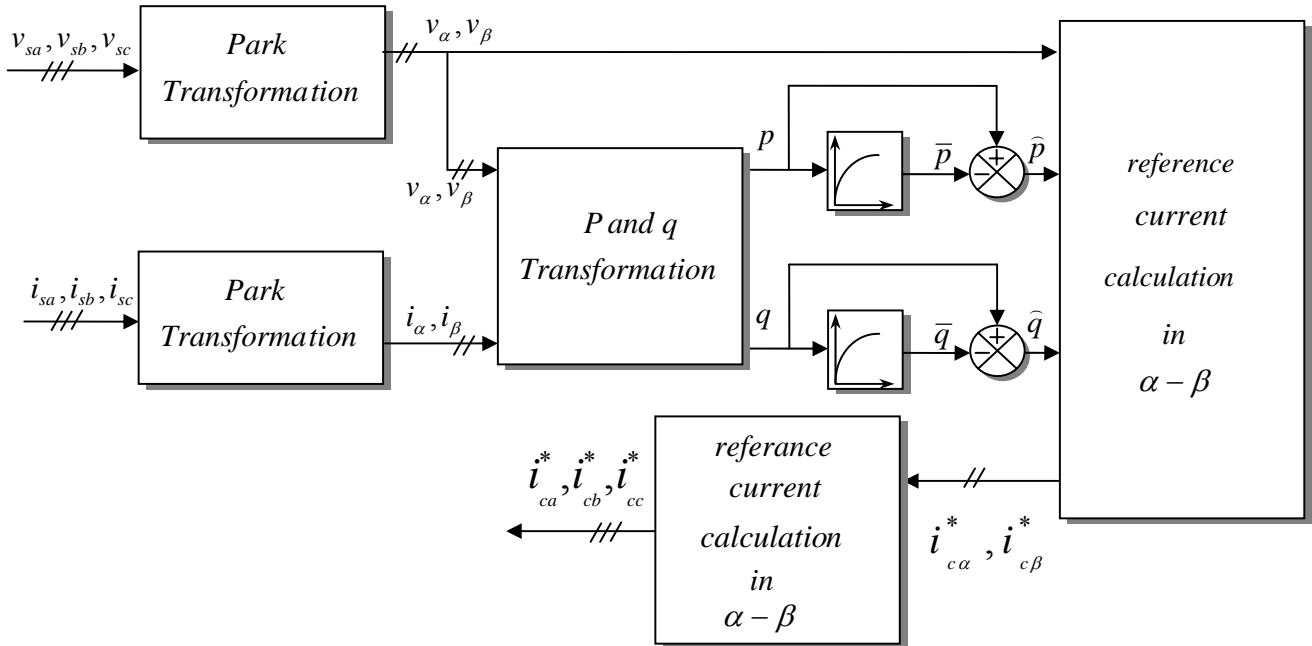

Fig.2. Block diagram for the instantaneous active and reactive power

The (SAPF) control strategy involves not only the production of currents whether to eliminate the undesired harmonics or to compensate reactive power, but also to recharge the capacitor value requested by VDC voltage in order to ensure suitable transit of powers to supply the inverter[8-12]. The storage capacity C absorbs the power fluctuations caused by the compensation of the reactive power, the presence of harmonics, and the active power control and also by the losses of the converter. The average voltage across the capacitor terminals must be kept at a constant value. The regulation of this voltage is made by absorbing or providing active power on the electrical network. The correction of this voltage must be done by adding the fundamental active current in the reference current of (SPAF) [30].

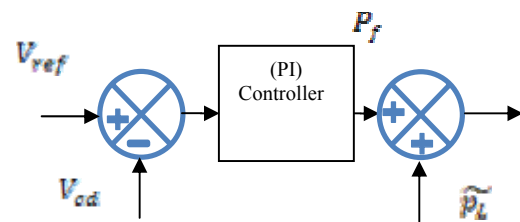

Fig.3. Control of DC Voltage

To realize these objectives, a controller as shown in Figure.3 is added to regulate the capacitor dc voltage of the (SAPF). In this circuit, the actual dc capacitor voltage is detected and compared with the reference value, and the error is amplified then is added to the \tilde{P}_L , the output of high-pass filter in Figure. 2. Therefore, active power allowed into the capacitor is been changed and the dc voltage is controlled.

III. NEURAL NETWORKS FOR REFERENCE SOURCE CURRENT AND DC VOLTAGE CONTROL

In this work, the p-q theory is modeled, as depicted in Fig. 4, by an artificial neural network (ANN) made up of two

hidden layers with 12 neurons each, and one output layer with 3 neurons. The logarithmic activation function is the base of the two hidden layers neurons, and linear activation function for the output layer neurons.

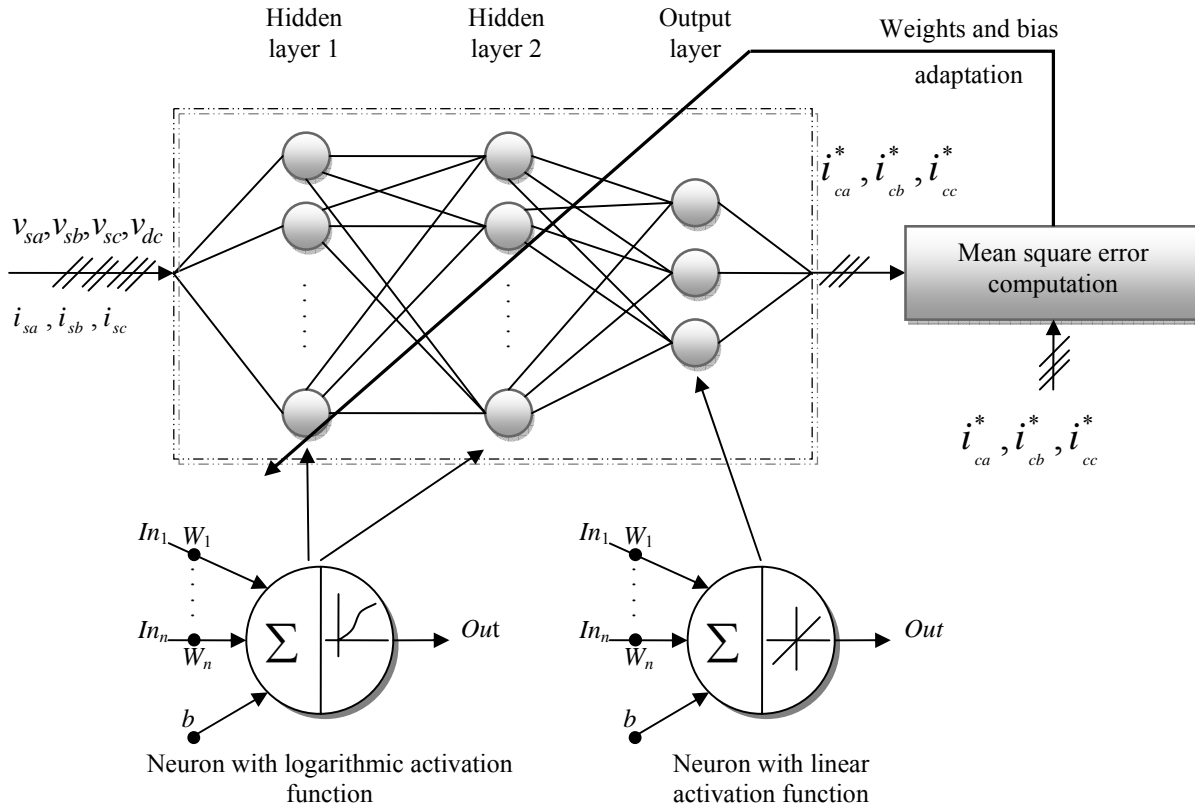

Fig.4. Neural network for (p-q theory) modelling

The ANN in Fig. 4 has seven inputs ($V_{sa}, V_{sb}, V_{sc}, V_{dc}, i_{sa}, i_{sb}, i_{sc}$) and three outputs ($i_{ca}^*, i_{cb}^*, i_{cc}^*$), as observed in the p-q theory. The model of the neurons of the hidden layers is represented in Fig.4, where each neuron has n inputs. This parameter varies in function of the chosen hidden layer, where n equals 7 if the neuron belongs to hidden layer 1, and n equals 12 if the neuron belongs to hidden layer 2. For the neurons of the output layer, n equals 12.

The adaptation of the weights (W) and bias (b) in the ANN, is based, first, on the computation of the mean square error (MSE) between the outputs of the PQ technique and those of the ANN, and secondly, on the execution of 'Levenberg-Marquardt backpropagation' algorithm [18-24].

IV. SIMULATION RESULTS

The performance of the proposed detection method using

artificial neural network (ANN) was examined through simulations. The system model was implanted in Matlab / Simulink environment. The (SAPF) was designed to compensate harmonics caused by nonlinear loads. The system model parameters are shown in Table I.

TABLE I SYSTEM PARAMETERS	
Parameters	
Supply phase voltage U	220 V
Supply frequency f_s	50 Hz
Filter inductor L_f	0.7 mH
Dc link capacitor C_f	0.768474 mF
Vdc	850V
Smoothing inductor L_{smooth}	70 μ H

A three-phase diode rectifier with an RL load was used as a harmonic producing load. The load value is (resistance was $10/3 \Omega$ and the inductance 60 mH. or Load apparent power $SL=82VA$).

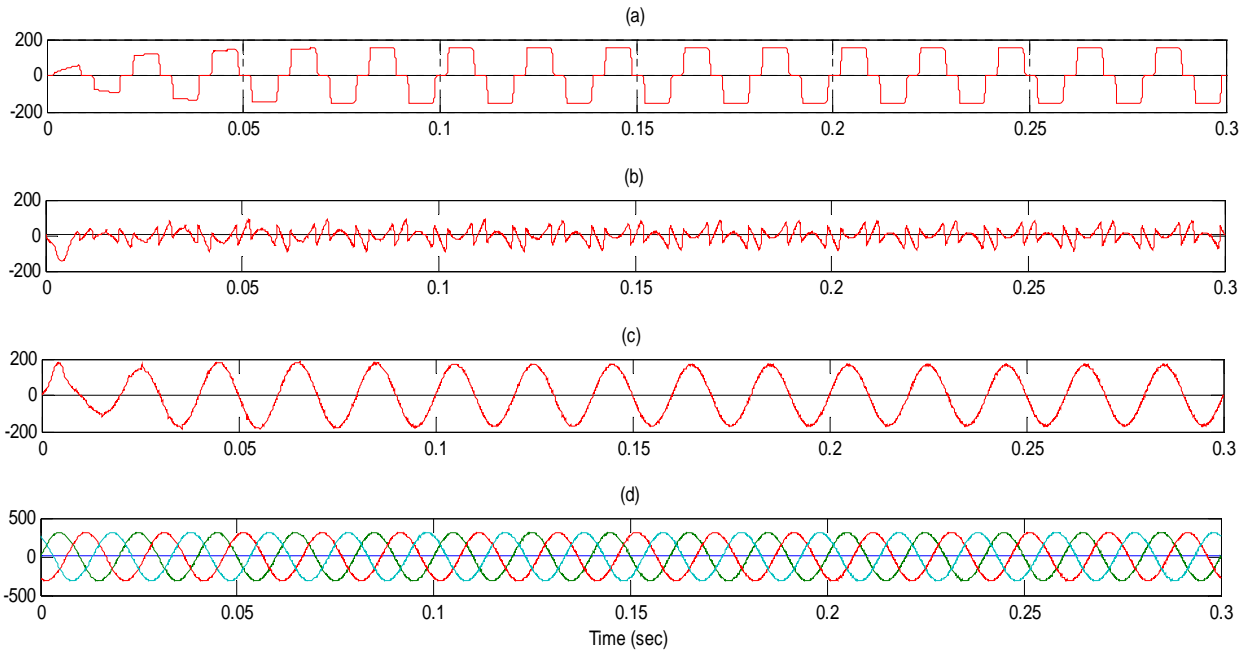

Fig.5. (a) Simulated phase-a load current waveforms, (b) Simulated phase-a reference current waveforms , (c) Simulated phase-a the supply current waveforms , (d) Simulated the supply voltage waveforms with a (p-q theory) method

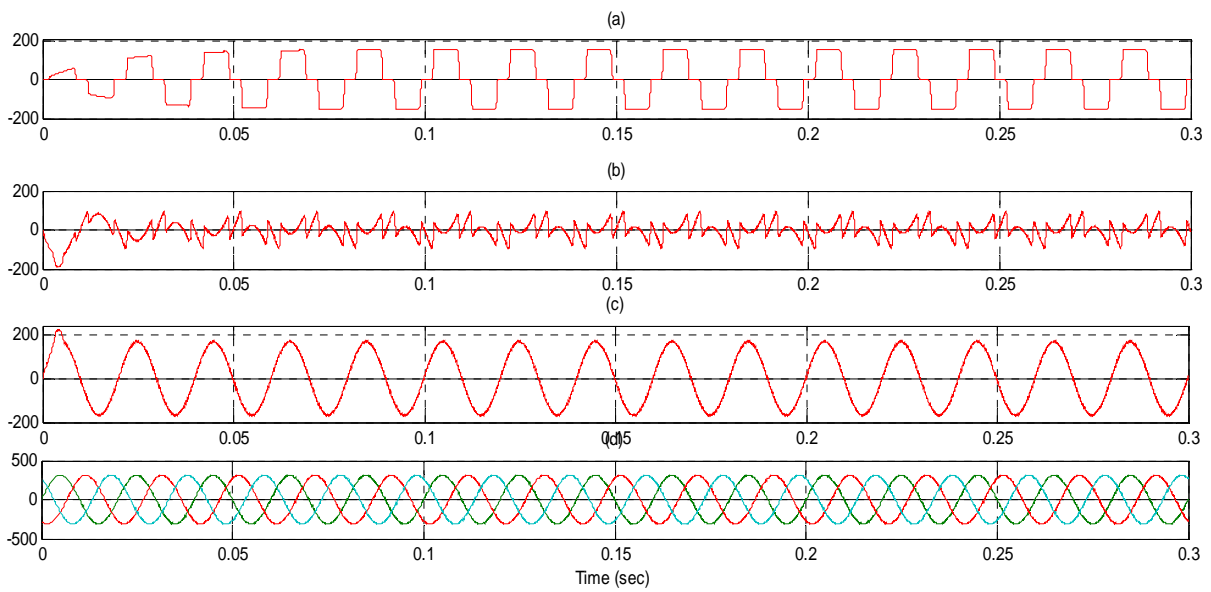

Fig.6. (a) Simulated phase-a load current waveforms, (b) Simulated phase-a reference current waveforms , (c) Simulated phase-a the supply current waveforms , (d) Simulated the supply voltage waveforms with a (ANN) method

TABLE II HARMONIC SUPPLY CURRENT PHASE-A-COMPONENT

Harmonic Supply Current Components			
Isa(n)/Isa(1) [%]			
n	load	p-q theory	(ANN) method
5	19.59	0.37	0.28
7	13.56	0.43	0.37
11	8.06	0.17	0.04
13	6.48	0.27	0.24
17	4.38	0.41	0.06
19	3.63	0.21	0.17
23	2.51	0.11	0.06
25	2.08	0.15	0.12
29	1.43	0.21	0.04
31	1.18	0.05	0.08
35	0.82	0.07	0.04
37	0.70	0.03	0.05
41	0.56	0.16	0.03
43	0.51	0.01	0.05
47	0.46	0.11	0.04
49	0.44	0.05	0.05
THD	26.91	1.05	0.74

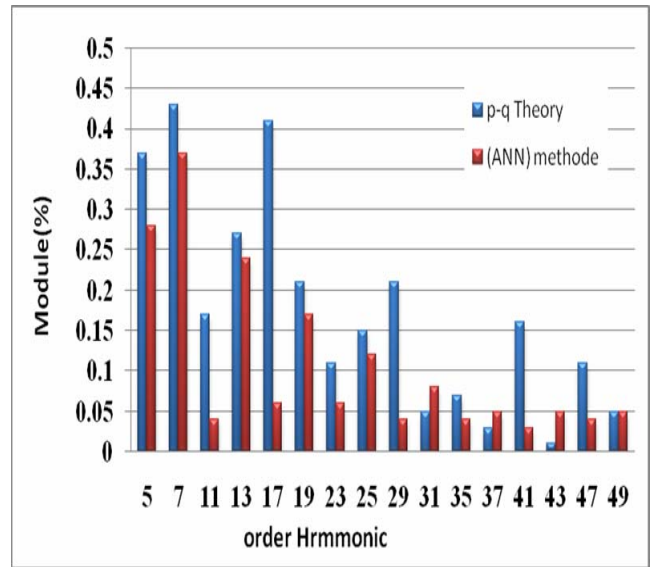

Fig.7. Harmonic spectrum of supply current Phase 'a'

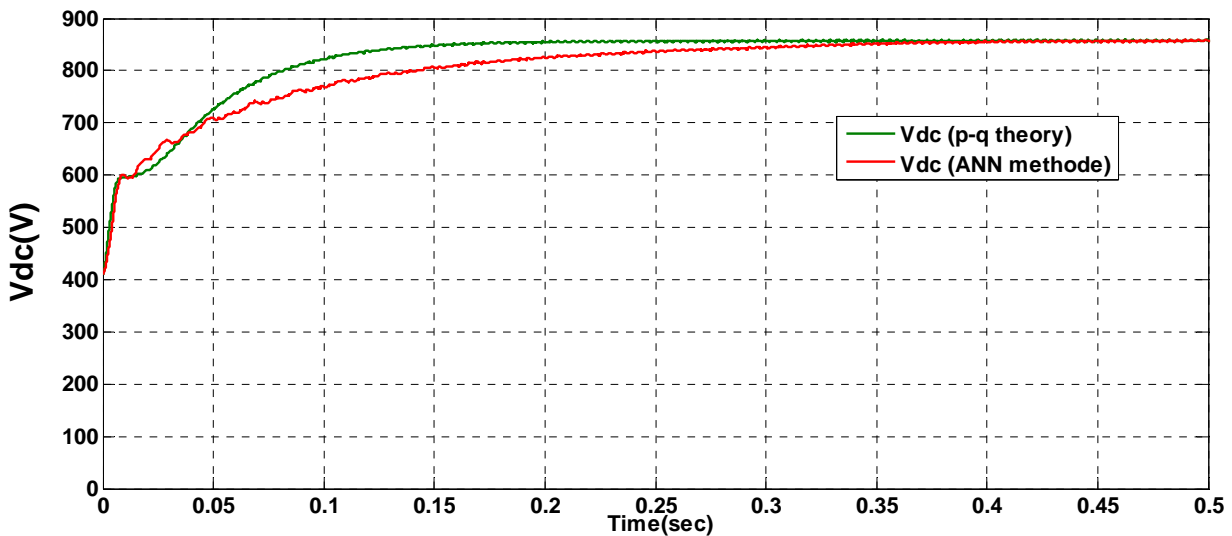

Fig.8.DC link voltage regulation comparison between (p-q theory) and (ANN)

TABLE .III PERFORMANCE INDICES, SYSTEM WITH THE TWO METHODS

	(ANN) Case	(p-q theory) Case
Rise Time	0.1488	0.08598
overshoot	0%	0%
Settling Time(s)	0.15	0.42
Steady-state Error	0.3280%	0.3301%

In simulations the two different identification methods were

used .Because of the (ANNs) capacities to optimize simultaneously their weights and biases in an on-line training process; this approach improves the (SAPF) performance. The filtering result can be seen in Figure 5and 6. The deformations have now been reduced and the harmonic distortion calculated up to 2.5 kHz (THD2.5kHz) has been weakened. Although the filtering performance especially with the low order harmonics has been improved, this can be seen in Table II, where the THD calculated up to 2.5 kHz remains less than the case of

(p-q theory) approach.

Figure 8 represents the controlled voltage in the borders of the condenser. We compared between the pro-posed approach (ANN) and the case of the PI controller which is incorporated in (p-q theory) as shown in Table III It seems clearly that the PI controller in (p-q theory) is characterized by a very low Rising Time and Settling Time (T_r is equal to 0.08598 s, T_s is equal to 0.15 s) compared to the (ANN) case

(T_r is equal to 0.1488 s, T_s is equal to 0.42 s). The former case presents acceptable results at the level of DC voltage control.

V.CONCLUSION

The work presented in this paper makes a significant contribution to identification and control strategies in order to improve the (SAPF) performance. The novel approach is based on intelligent neural techniques, has been proposed. The performance of the proposed (ANN) was verified through simulation studies with Matlab and confronted with classical technical. The complete (SAPF) structure has been implanted to compensate harmonics caused by nonlinear loads.

At this level, comparative studies between the neural approach and; one of the most conventional techniques used to extract the harmonic component of the load current to produce reference currents; (p-q theory) have been accomplished. The achieved results can be asserted that all the identifying objectives of the harmonic currents could be satisfied by the approach based on neural networks. However, the (p-q theory) merit is that the latter contains integrated (PI) controller, added to regulate the capacitor dc voltage of the (SAPF).

REFERENCES

- [1] Youssef ,K., "Industrial power quality problems Electricity Distribution," IEE Conf. Publ No. 482, vo1.2. June 2001, 18-21.
- [2] Ping.W.,Zhixiong.Z., Houquan.C., 'A DSP-based active power filter for three-phase power distribution systems', 2009International Conference on Computer Engineering and Technology 978-0-7695-3521-0/09 \$25.00 © 2009 IEEE DOI 10.1109/ICCET.2009.140
- [3] C. Benachaiba, S. Dib and O. Abdelkhlek, 'Genetic Algorithm-Based Self-Learning Fuzzy PI Controller for Shunt Active filter', International Journal of Applied Engineering Research V. 1/ N. 2 (IJAER) 2006, pp. 203-216.
- [4] O. Abdelkhalek, C. Benachaiba, M.Haidas, T. Benslimane, 'A new technique applied to a fuzzy regulator to control the shunt active filter DC bus voltage', journal "Information Technology and Control (ITC) 2008" , September 2008 Vol.37 No.3 (ISSN 1392-124X).
- [5] Hugo.A, Ramos.C., Aurelio.M., Gary W. C., 'Real-Time Shunt Active Power Filter Compensation', IEEE TRANSACTIONS ON POWER DELIVERY, VOL. 23, NO. 4, OCTOBER 2008
- [6] M. Rafiei, Verification of global optimality of the OFC active power filters by means of genetic algorithms, Proc. WSEAS Int. Conf. on Systems, Vouliagmeni, Athens, Greece, Jul. 10-12, 2006, pp. 559-564
- [7] H. Akagi, S. Srianthumrong and Y. Tamai, "Comparisons in circuit configuration and filtering performance between hybrid and pure shunt active filters", IEEE 38th Conf on Industry Applications, Vol. 2, pp. 1195-1202, October 2003.
- [8] S.Rahmani, K. Al-Haddad, . F.Fnaiech. "A Three-Phase Shunt Active Power Filter for Damping of Harmonic Propagation in Power Distribution Systems " IEEE ISIE 2006, July 9-12, 2006, Montreal, Quebec, Canada, pp. 1760-1764.

- [9] Hui.L, Guohai.L and Yue. S., 'A Novel harmonics Detection Method Based on Wavelet Algorithm for Active Power Filter', Proceedings of the 6th World Congress on Intelligent Control and Automation, June 21 - 23, 2006, Dalian, China.
- [10] Khadkikar.V.,Chandra.A., Singh. B.N., 'Generalised single-phase p-q theory for active power filtering: simulation and DSP-based experimental investigation', Published in IET Power Electronics Received on 2nd September 2007 Revised on 5th April 2008 doi: 10.1049/iet-pel:20070375.
- [11] O. Abdelkhalek, C. Benachaiba, T. Benslimane, M. Haidas, 'A Novel Theory of Reference Harmonic Current Identification Based on the Per Unit System Used for The Active Filters', Istanbul University – Journal of Electrical & Electronics Engineering (JEEE), 2008 Vol. 8, No. 2, pp. 747-757.
- [12] O. Abdelkhalek, C. Benachaiba, T. Benslimane, M. Haidas, ' A Novel Theory of Reference Reactive Current Identification Based on the Per Unit System Used for The Active Filters ', Istanbul University – Journal of Electrical & Electronics Engineering (JEEE), 2008 Vol. 8, No. 2, pp. 759-767.
- [13] A. TAHRI, A. DRAOU "Instantaneous Active and Reactive Power Measuring Method in Three Phase Power System" Leonardo Electronic Journal of Practices and Technologies, Issue 6, January-June 2005, p. 17-28.
- [14] S. A. Soliman, K. El-Naggar, and Al-Kandari, "Kalman filtering based algorithm for low frequency power systems sub-harmonics identification," International Journal of Power Energy Systems, vol.17, 1997.
- [15] Matthew.A. G., 'A Comparative Analysis Of Proportional-Integral compensated And Sliding mode Compensated Shunt Active Power Filters', A Thesis Submitted to the Faculty of Mississippi State University in Partial Fulfillment of the Requirements for the Degree of Master of Science in Electrical Engineering in the Department of Electrical and Computer Engineering ,December 2004, Copyright 2005 by Gray, Matthew Alan , 10-18
- [16] M. Ahmed 'Sliding Mode Control For Switched Mode Power Supplies', Thesis for the degree of Doctor of Science (Technology) to be presented with due permission for public examination and criticism in the auditorium 1382 at Lappeenranta University of Technology, Lappeenranta, Finland on the 14th of December 2004, at noon. Page(s):32-34.
- [17] C. Benachaiba, B. Ferdi, 'A Comparative Study of IEC 61000 Part 3-2 & 3-4 and IEEE 519-1992 Standards in Low Voltage Applications', International Review of Electrical Engineering (IREE) December 2007, pp. 771-776.
- [18] Yongtao,Dai1 Wenjin, Dai2 "Harmonic and Reactive Power Compensation with Artificial Neural Network Technology "Proceedings of the 7th World Congress on Intelligent Control and Automation June 25 - 27, 2008, Chongqing, China.
- [19] M. Rukonuzzaman ,M.Nakaoka "Adaptive Neural Network Based Harmonic Current Compensation in Active Power Filter " 0-7803-7044-9/01/\$10.00 02001 IEEE,pp 228 1- 2286.
- [20] O. Bouhali, M. Berkouk, B. Francois, C. Saudemont, S. Labiod "Solving Harmonics Elimination Problem in Voltage-controlled Three Phase Inverter using Artificial Neural Networks" J. Electrical Systems 1-1 (2005): 47-61.
- [21] N. K.Nguyen, D. Ould Abdeslam, P.Wira, D.Flieller, J. Mercklé "Artificial Neural Networks for Harmonic Currents Identification in Active Power Filtering Schemes" 9978-1-4244-1766-7/08-2008 IEEE, pp 2696-2701.
- [22] W.Dai, T.Huang, N.Lin "Single-phase Shunt Hybrid Active Power Filter Based on ANN" Fourth International Conference on Fuzzy Systems and Knowledge Discovery (FSKD 2007), 0-7695-2874-0/07 © 2007,IEEE.
- [23] W.Dai , Y.Wang "Active Power Filter of Three-phase Based on Neural Network" Fourth International Conference on Natural Computation, 978-0-7695-3304-9/08 © 2008 IEEE.
- [24] N.Pecharanin, M.Sone, H.Mitsui "An Application Of Neural Network For Harmonic Detection In Active Filter" 0-7803-1901-X/94 1994 IEEE,pp 3756-3760.

R. Dehini : received the stage license degree in electrical & engineering from the national high school of technical teachings (ENSET) ALGERIA. Currently, He is working toward the Doctorate degree. His interests are in electrical power quality.

A. Bassou :received the state engineer degree in Electronic Engineering in 1997 from the University of Abou Bekr Belkaïd de (Tlemencen-Algeria) and the M.S. degree in 2000 from University of Djillali Liabes (Sidi Bel Abbas–Algeria). In 2006 he received the doctorate degree from University of Djillali Liabes (Sidi Bel Abbas–Algeria) (USTO), Algeria and currently holding the post of Assistant Professor. His current research and teaching interests are in the areas of Artificial Neural Networks, telecommunication and signal. Presently he is supervising doctoral students working in the field of telecommunication and Artificial Neural Networks.

B. Ferdi :received the stage engineer degree in electrical & engineering from the University of Boumerdes (INELEC), in 1991 and the MS degree in 2008 from Bechar University ALGERIA. Currently, He is working toward the Doctorate degree. His areas of interest are hybrid active power filters, applications of power electronics, and power quality improvement.