

# Nonlinear model predictive control for solid oxide fuel cell system based on Wiener model

T.H. Lee, J.H. Park, S.M. Lee and S.C. Lee

*Abstract*—In this paper, we consider Wiener nonlinear model for solid oxide fuel cell (SOFC). The Wiener model of the SOFC consists of a linear dynamic block and a static output non-linearity followed by the block, in which linear part is approximated by state-space model and the nonlinear part is identified by a polynomial form. To control the SOFC system, we have to consider various view points such as operating conditions, another constraint conditions, change of load current and so on. A change of load current is the significant one of these for good performance of the SOFC system. In order to keep the constant stack terminal voltage by changing load current, the nonlinear model predictive control (MPC) is proposed in this paper. After primary control method is designed to guarantee the fuel utilization as a proper constant, a nonlinear model predictive control based on the Wiener model is developed to control the stack terminal voltage of the SOFC system. Simulation results verify the possibility of the proposed Wiener model and MPC method to control of SOFC system.

*Keywords*—SOFC, model predictive control, Wiener model.

## I. INTRODUCTION

As high efficiency and more environment-friendly energy sources, fuel cell (FC) among many kinds of distributed resources is considered the most important one. The FC plant efficiency can be as high as 40 – 55% because FC generates electrical energy directly from chemical reactions, unlike heat engine or gas turbine. Until now, various types of fuel cell is investigated, but recently among the these types of fuel cell, solid oxide fuel cell (SOFC) has attracted considerable interest as it offers wide application ranges, flexibility in the choice of fuel, high system efficiency and possibility of operation with an internal reformer [1]. It is well known that SOFC systems are sealed, and work in a high-temperature (600 – 1000° C) environment. So, the heat generation from the electrochemical reactions and the high-temperature environment can be used for cogeneration applications increasing the efficiency up to 70%.

During the last several years, SOFC modelling of the nonlinear dynamics have been investigated [2]-[4], for SOFC is a

T.H Lee and J.H. Park are with Department of Electrical Engineering, Yeungnam University, 214-1 Dae-Dong, Kyongsan 712-749, Republic of Korea. Email: jessie@ynu.ac.kr

S.M. Lee is with Department of Electronic Engineering, Daegu University, Gyungsan 712-714, Republic of Korea. Email: moony@daegu.ac.kr

S.C. Lee is with Public and Original Technology Research Center, Daegu-Gyungbuk Institute of Science and Technology (DGIST), Taegu 790-784, Republic of Korea. Email: sclee@dgist.ac.kr

The research of J.H. Park and S.C. Lee was financially supported by the Ministry of Knowledge Economy (MKE), Korea Institute for Advancement of Technology (KIAT) and Dae-Gyeong Leading Industry Office through the Leading Industry Development for Economic Region. Also, The research of S.M. Lee was supported by Basic Science Research Program through the National Research Foundation of Korea (NRF) funded by the Ministry of Education, Science and Technology (2010-0011460 ).

dynamic device which will affect the dynamic behavior of the power system to which it is connected. However, most of these models indicated the detailed electrochemical processes. These models are very useful to analyze the transient characteristics of the SOFC, but they are too complicated to be used in controller design. So, for developing effective control strategies, the system identification for SOFC is needed. Recently, a study which identified SOFC system to various system model such as Hammerstein model, neural network, nonlinear ARX model and so on, has been introduced [5]-[6].

A special class of nonlinear models is block oriented one in which a linear time invariant dynamic block is preceded and followed by a static non-linearity. These models, such as Hammerstein and Wiener, do not require much fundamental knowledge about a system only require input-output data, and they are relatively easy to be constructed using process data. The Wiener model consists of a linear dynamic block and a static output non-linearity followed by the block. Although Wiener models only represent a small subclass of all nonlinear models, they have appeared useful in modeling several nonlinear processes encountered in the process industry, such as distillation columns [7] a heat exchanger [8] and pH neutralization processes [9].

As is well-known, model predictive control (MPC), also known as receding horizon control (RHC), is a popular technique for the control of slow dynamical systems, such as those encountered in chemical process control. At every time instant, MPC requires the on-line solution of an optimization problem to compute optimal control inputs over a fixed number of future time instants. Although more than one control input is generally calculated, only the first one is implemented. At the next sampling time, the optimization problem is reformulated and solved with new measurements obtained from the system. The on-line optimization can be typically reduced to either a linear program or a quadratic program. Since MPC can consider a finite horizon cost function, it can easily handle time varying tracking commands, input and output constraints and so on. For this reason, it has been widely investigated in academia and in industry [10]-[12].

There are several methods to relax the computational demand of the nonlinear optimization problem. Wang and Hendriksen [13] suggest the use of a prediction horizon equal to one, in which the optimal solution can be found by solving a polynomial equation. An approach used by Gerksic et al. [14] is to linearize the predictions around a control sequence obtained from previous iterations. Norquay et al. [15] use the specific structure of Wiener models to relax the computational demand. This is done by inverting the static nonlinearity, thus essentially removing it from the control problem, which en-

ables the use of linear MPC techniques for the remaining linear block. By the way, every suggested Wiener model predictive control (WMPC) algorithms are considered on regulation and tracking problems based on state feedback or state observer based form.

In this paper we propose a design method of MPC for SOFC. In order to design the model predictive controller, we identify SOFC model to Wiener model. The proposed control law is based on integral action form to provide zero offset for constant command signals and the closed loop stability is guaranteed under linear matrix inequality (LMI) conditions on the terminal weighting matrix using the decreasing monotonicity property of the performance. Through a simulation example, we show that the proposed schemes can be appropriate tracking controllers for Wiener models

### A. Basic reaction of SOFC

Two ceramic electrodes are the basic components of the SOFC which are anode and cathode channel. In the fuel cell, fuel is supplied to the anode and air is supplied to the cathode. At the cathode-electrolyte interface, oxygen molecules accept electrons coming from the external circuit to form oxide ions. The electrolyte layer allows only oxide ions to pass through and at the anode-electrolyte interface, hydrogen molecules present in the fuel react with oxide ions to form steam and electrons get released. These electrons pass through the external circuit and reach the cathode-electrolyte layer, and thus the circuit is closed. The electrochemical reactions are given as follows:

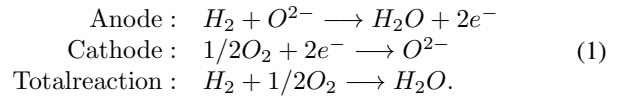

### B. The partial pressure

The output voltage is the most important variable in SOFC because most of control purpose is to make actual voltage trajectory and desired voltage trajectory as same. As considering results in previous study, output voltage is consisted of partial pressure of hydrogen, oxide and water by Nernst's equation. Thus to control the output voltage, we should know dynamics of each partial pressure. In many paper about SOFC, it is clearly developed. The Laplace transformed partial pressure inside the channel of hydrogen, oxygen and water are as follows :

$$p_{H_2}(s) = \frac{1/K_{H_2}}{1 + \tau_{H_2}s} (q_{H_2}^{in} - 2K_r I) \quad (2)$$

$$p_{O_2}(s) = \frac{1/K_{O_2}}{1 + \tau_{O_2}s} (q_{O_2}^{in} - K_r I) \quad (3)$$

$$p_{H_2O}(s) = 2K_r I \frac{1/K_{H_2O}}{1 + \tau_{H_2O}s}. \quad (4)$$

### C. The output voltage

The SOFC consists of hundreds of cells connected in series or in parallel. By regulating the fuel valve, the amount of fuel into the SOFC can be adjusted, and the output voltage of the SOFC can be controlled. The Nernst's equation determine the average voltage magnitude of the fuel cell stack. In addition, if we consider terms of voltage loss then we can get more perfectly voltage equation of SOFC. Hence, applying Nernst's equation and terms of voltage loss, the output voltage of the SOFC can be modeled as follows:

$$V_{dc} = E - \eta_{act} - \eta_{conc} - \eta_{ohm}, \quad (5)$$

where

$$E = N_0 \left( E^0 + \frac{RT}{2F} \ln \frac{p_{H_2} p_{O_2}^{1/2}}{p_{H_2O}} \right) \quad (6)$$

$$\eta_{act} = \frac{\beta}{\alpha} \log I \quad (7)$$

$$\eta_{conc} = \frac{RT}{2F} \ln(1 - I/I_L) \quad (8)$$

$$\eta_{ohm} = IR_{ohm}. \quad (9)$$

## II. SOFC DYNAMIC MODEL

Until now SOFC dynamic model has been widely investigated. Thus we briefly review SOFC dynamics based on previous researches ([2]-[4], [16]-[17]). Fig. 1 displays whole of SOFC process in this section.

### Nomenclature

$E$	open – circuit reversible potential(V)
$E^0$	standard reversible cell potential(V)
$F$	Faraday's constant( $c \text{ mol}^{-1}$ )
$I$	stack current(A)
$I_L$	limiting current(A)
$K_{H_2}$	valve molar constants for hydrogen( $\text{mol s}^{-1} Pa$ )
$K_{H_2O}$	valve molar constants for water( $\text{mol s}^{-1} Pa$ )
$K_{O_2}$	valve molar constants for oxygen( $\text{mol s}^{-1} Pa$ )
$K_r$	constant
$n$	number of electrons participating in the reaction
$N_0$	number of cells in the stack
$p_{H_2}$	partial pressure of hydrogen(atm)
$p_{H_2O}$	partial pressure of water(atm)
$p_{O_2}$	partial pressure of oxygen(atm)
$q_f$	mature gas flow rate( $\text{mol s}^{-1}$ )
$q_{H_2}^{in}$	input hydrogen flow( $\text{mol s}^{-1}$ )
$q_{H_2}^{out}$	output hydrogen flow( $\text{mol s}^{-1}$ )
$q_{H_2}^r$	hydrogen flow that reacts( $\text{mol s}^{-1}$ )
$q_{O_2}^{in}$	input oxygen flow( $\text{mol s}^{-1}$ )
$r_{H-O}$	hydrogen – oxygen flowratio
$R$	gas constant( $J \text{ mol}^{-1} K$ )
$R_{ohm}$	Ohmic resistance( $\Omega$ )
$T$	cell temperature(K)
$u_f$	fuel utilization
$V$	compartment volume( $m^3$ )

### Greek letters

$\beta$	Tafel slope
$\eta_{act}$	activation losses(V)
$\eta_{conc}$	concentration losses(V)
$\eta_{ohm}$	Ohmic losses(V)
$\tau_{H_2}$	response time for hydrogen flow(s)
$\tau_{H_2O}$	response time for water flow(s)
$\tau_{O_2}$	response time for oxygen(s)
$\theta$	Tafel constant

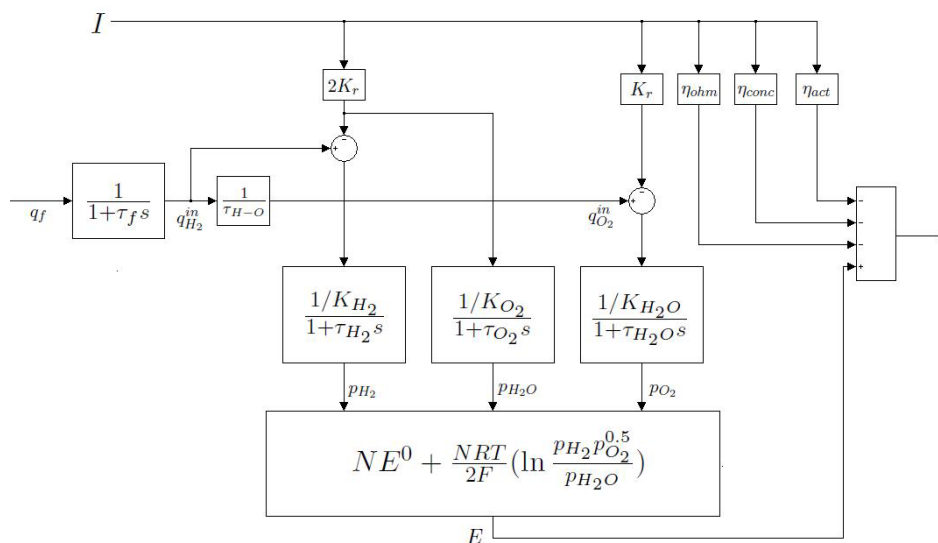

Fig. 1: SOFC dynamic model

#### D. Fuel utilization

Fuel utilization is defined as:

$$u_f = \frac{q_{H_2}^{in} - q_{H_2}^0}{q_{H_2}^{in}} = \frac{q_{H_2}^r}{q_{H_2}^{in}} = \frac{N_0 I}{2F q_{H_2}^{in}} \quad (10)$$

It is one of the most important operating variables affecting the system performance of FC. When the stack is operated at a high fuel utilization, the voltage density decrease. Furthermore, if fuel utilization is too large, it becomes impossible for the SOFC to sustain the voltage across the load. However, it is a waste under a low fuel utilization when there is no cycling of the anode gas flow. Therefore, the fuel utilization should be carefully selected to achieve the high SOFC performance. From Eq. (10), the SOFC stack is operated with constant steady-state utilization by controlling the natural gas input flow to the stack as:

$$q_f = \frac{N_0 I}{2F u_{fs}} \quad (11)$$

where  $u_{fs}$  is the desired utilization in steady-state.

### III. MODEL PREDICTIVE CONTROL

In this section, we briefly introduce main framework of model predictive control method for Wiener model which is studied by Lee et al [18].

Nonlinear Wiener model consists of a linear dynamic block and a static output non-linearity followed by the block. Let us consider the following identified Wiener model equation described by

$$\begin{aligned} x(k+1) &= Ax(k) + Bu(k) \\ y(k) &= Cx(k) + Du(k) \\ z(k) &= h(y(k)), \end{aligned} \quad (12)$$

where  $A, B, C$  and  $D$  are the system matrices of the linear dynamic block,  $x(k) \in \mathcal{R}^n$  is the state,  $u(k) \in \mathcal{R}^m$  and

$y(k) \in \mathcal{R}^l$  are the input and output of the linear block respectively.  $z(k) \in \mathcal{R}^l$  is the output of the nonlinear block and  $h(y(k))$  is the nonlinear mapping from  $y(k)$  to  $z(k)$ . The static nonlinear function  $h(\cdot)$  is assumed to be known and invertible.

The goal of this paper is to obtain static output feedback model predictive tracking control law which stabilizes (12) and makes outputs follow given command signals.

The considered controller has the following structure

$$u(k) = F(k)z(k) + N(k), \quad (13)$$

where  $F(k)$  and  $N(k)$  are design variables.

In this section, we consider integral action form because it provides zero-offset for constant command signals. We assume the control increment  $\delta u(k) \triangleq u(k+1) - u(k)$  and  $\delta y(k) \triangleq y(k+1) - y(k)$ . We replace  $u(k)$  with  $\delta u(k)$  and then we obtain the incremental model and performance index as follows:

$$\begin{aligned} x^e(k+1) &= A^e x^e(k) + B^e \delta u(k) \\ y(k) &= C^e x^e(k) \\ z(k) &= h(y(k)), \end{aligned} \quad (14)$$

where

$$\begin{aligned} A^e &= \begin{bmatrix} I & C \\ 0 & A \end{bmatrix}, B^e = \begin{bmatrix} D \\ B \end{bmatrix}, \\ C^e &= [ I \quad 0 ], x^e = \begin{bmatrix} y(k) \\ \delta x(k) \end{bmatrix}, \end{aligned}$$

and

$$\begin{aligned} \Delta J(k) = & \sum_{i=0}^{N-1} \left[ \{z(k+i|k) - z_r(k+i|k)\}^T Q \times \right. \\ & \{z(k+i|k) - z_r(k+i|k)\} \\ & \left. + \delta u(k+i|k)^T R \delta u(k+i|k) \right] + \\ & \begin{bmatrix} y(k+N|k) - y_r(k+N|k) \\ \delta x(k+N|k) \end{bmatrix}^T P^e(k+N) \\ & \times \begin{bmatrix} y(k+N|k) - y_r(k+N|k) \\ \delta x(k+N|k) \end{bmatrix}, \quad (15) \end{aligned}$$

where  $z_r(k+i)$  is given reference signals,  $N$  is fixed finite horizon and  $Q$  and  $R$  are positive definite diagonal weighting matrices. For our goal, the above performance index is minimized at the time  $k$ .

According to process in [18], we can obtain upper bound on the performance index :

$$\Delta J(k) < \bar{x}^e(k)^T \bar{P}^e(k) \bar{x}^e(k). \quad (16)$$

In order to design the optimized controller for Wiener model, it is key point to find minimalized  $\bar{P}^e(k+N)$ . So we can find proper  $\bar{P}^e(k+N)$  by following process:

- We obtain  $P^e(k+N) = P_f^e = \bar{P}^e(k+N)\{1, 1\}$  to stable Wiener systems.
  - We assume  $z_r = 0$  and calculate  $P_f^e$ .
  - Nonlinearities are considered by Norquay' inversion method which is referred in preliminaries.
- We find  $\bar{P}^e(k+i)$ ,  $F(k+i)$  and  $N(k+i)$  with given  $\bar{P}^e(k+i+1)$  recursively for tracking problem during fixed finite horizon.
  - Weighting matrix  $H(k+i)$  is changed with respect to command signals.
- Repeat same work at the next time.
  - We repeat this until the desired time.

The basic concept of this Wiener MPC algorithm is presented in [19] and consists of inverting the output nonlinearity, thus removing it from the control problem. The performance index (15) is changed into

$$\begin{aligned} \Delta J(k) = & \sum_{i=0}^{N-1} \left[ \{y(k+i|k) - y_r(k+i|k)\}^T \hat{Q} \times \right. \\ & \{y(k+i|k) - y_r(k+i|k)\} \\ & \left. + \delta u(k+i|k)^T R \delta u(k+i|k) \right] + \\ & \begin{bmatrix} y(k+N|k) - y_r(k+N|k) \\ \delta x(k+N|k) \end{bmatrix}^T P^e(k+N) \\ & \times \begin{bmatrix} y(k+N|k) - y_r(k+N|k) \\ \delta x(k+N|k) \end{bmatrix}, \quad (17) \end{aligned}$$

where

$$\begin{aligned} \hat{Q}(k+i) &= \left( \frac{\delta h(y)}{\delta y} \Big|_{y=h^{-1}(z_r(k+i))} \right)^T Q \times \\ & \left( \frac{\delta h(y)}{\delta y} \Big|_{y=h^{-1}(z_r(k+i))} \right) \\ &= H(k+i)^T Q H(k+i). \end{aligned}$$

TABLE I: SOFC operating point

Parameter	Unit	Value
$T$	$K$	1273
$F$	$Cmol^{-1}$	96485
$R$	$J(molK)^{-1}$	8.314
$N_0$	-	384
$E^0$	$V$	1
$K_r$	$mol(sA)^{-1}$	$0.996 \times 10^{-3}$
$K_{H_2}$	$mol(sPa)^{-1}$	$8.32 \times 10^{-6}$
$K_{H_2O}$	$mol(sPa)^{-1}$	$2.77 \times 10^{-6}$
$K_{O_2}$	$mol(sPa)^{-1}$	$2.49 \times 10^{-5}$
$\tau_{H_2}$	$s$	26.1
$\tau_{H_2O}$	$s$	78.3
$\tau_{O_2}$	$s$	2.91
$R_{ohm}$	$\Omega$	0.126
$q_{H_2}^{in}$	$mol s^{-1}$	Variable
$\beta$	-	0.11
$\theta$	-	0.05
$I_L$	$A$	800
$n$	-	Variable
$I$	$A$	Variable
$u_{fs}$	-	0.8

And nonlinearity output and control input can be written as:

$$\begin{aligned} z(k+i) &= h(y(k+i)) = H(k+1)y(k+i) \\ \delta u(k+i) &= F(k+i)H(k+i)y(k+i) + N(k+i) \end{aligned}$$

Steps of Section 3 in this paper was proposed in [18] already. By using the Theorem 2 in [18], we will show results of control of Wiener model for SOFC in next section.

#### IV. SIMULATION RESULTS

In this section, we present numerical experiments to show the validation of the identified Wiener model for SOFC and the proposed MPC scheme. In addition, constant fuel utilization control is presented.

##### A. The result of system identification for SOFC

To establish the desired Wiener model, we use the SOFC simulator [20] in MATLAB which is developed by Wang and Nehrir. The operating conditions of SOFC simulator is specified in Table 1. Now, identified parameters are as follows:

$$\begin{aligned} A &= \begin{bmatrix} 0.9995 & -0.2824 & -0.0752 \\ 0.0143 & 0.9896 & 0.6329 \\ 0.0001 & -0.0076 & 0.9536 \end{bmatrix}, \\ B &= \begin{bmatrix} -47.0236 \\ 11.0719 \\ 0.0128 \end{bmatrix} \\ C &= [-0.2750 \quad -0.4587 \quad 0.5252], \\ D &= 2.9167e+003 \\ h(y) &= 0.0937y^3 - 0.3156y^2 + 1.0193y + 0.0348. \end{aligned}$$

To verify whether identified Wiener model is compatible, we conduct a experiment which demonstrate relationship between input (hydrogen flow) and output (voltage). When a fuel flow is changed from  $0.9 \times 10^{-3}$  to  $1.4 \times 10^{-3} [mol s^{-1}]$  at  $I = 70A$ , the output voltage of the SOFC simulator and the output voltage of the Wiener model are represented in Fig. 2. It shows that two graphs are almost same and the suitability of identified

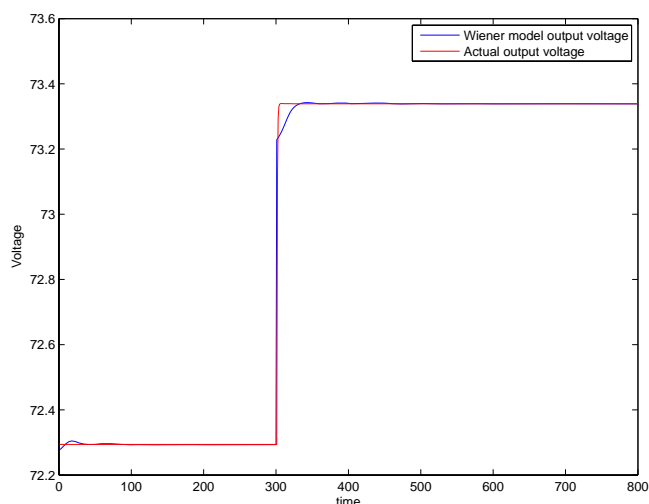

Fig. 2: Output voltage of actual and Wiener model

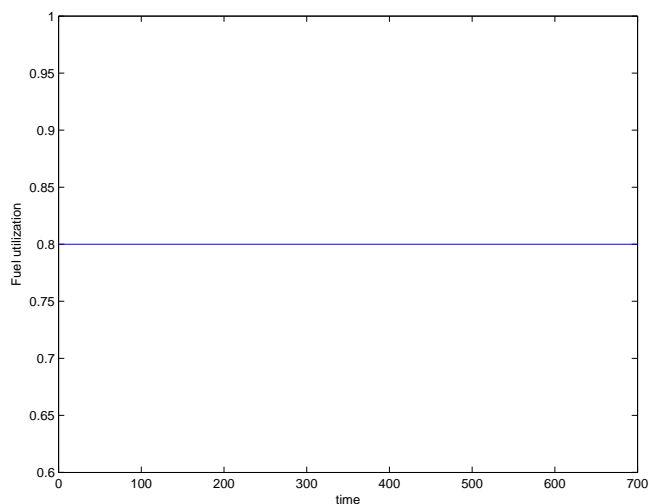

Fig. 4: Constant fuel utilization control

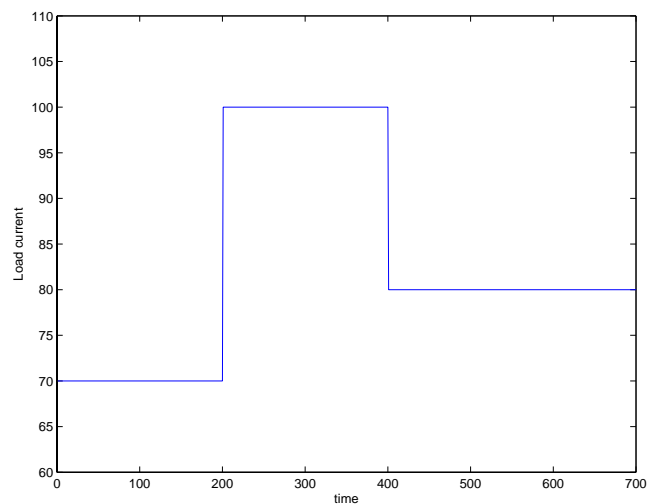

Fig. 3: Load current

choose the current disturbance as a multiple step signal which increase from 70A to 100A at 200 s, and reduce from 100A to 80A at 400 s. The load current disturbance is shown in Fig.3. Fig. 4 displays fuel utilization of this simulation. From Fig. 4, we can see the fuel utilization of the SOFC can be controlled as steady-state constant by regulating the natural gas input flow according to the stack current.

In order to prove the validity of our MPC based on Wiener model for SOFC, we conduct constant output voltage control at the same current disturbance. For this simulation, following parameter for MPC method is selected

$$Q = 10, R = 0.01, N = 3.$$

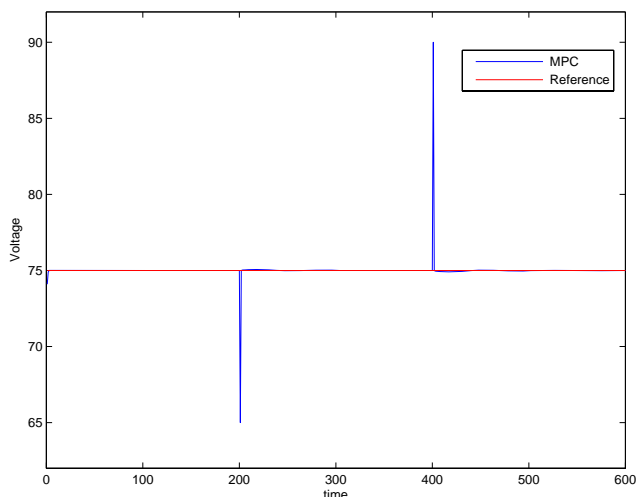

Fig. 5: Constant voltage control based on MPC

Wiener model is outstanding. To evaluate the suitability of identified Wiener model, the VAF is used which compute the percentage variance accounted for (VAF) between two signals. The VAF of two signals that are the same is 100%. If they are different, the VAF will be lower. The VAF is often used to verify the correctness of a model, by comparing the real output with the estimated output of the model. VAF is defined as follows:

$$VAF = \left(1 - \frac{y - y_{est}}{y}\right) \times 100[\%]. \quad (18)$$

So, VAF of Fig.2 is 99.6%, it means identified Wiener model for SOFC in this paper can replace actual SOFC system.

### B. Fuel utilization and output voltage control

We can regulate the input hydrogen flow by using Eq.(11). To prove the effectiveness of the control strategies, we

If finite horizon step,  $N$ , is increased then performance of controller is more good but amount of calculation of MPC controller is increased. The other side, small  $N$  has low probability about to get feasible MPC controller. Fig. 5 shows

that the output voltage using MPC controller can achieve the desired value in changing load current. And the hydrogen input flow,  $q_{H_2}^{in} [mol s^{-1}]$ , in this constant voltage control using MPC is indicated in Fig. 6.

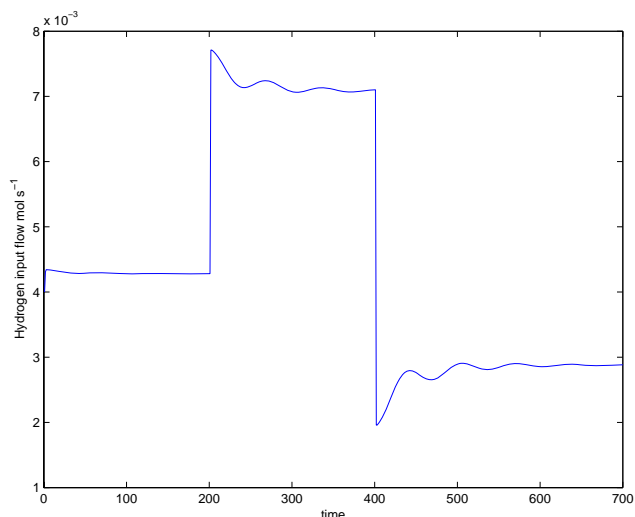

Fig. 6: The hydrogen flow at MPC

## V. CONCLUSIONS

To effectively control the SOFC system, the Wiener model is used to identify nonlinear dynamic behavior of SOFC system. By regulating the input hydrogen flow, SOFC system can be controlled as each control purpose. As results in Section 4, we prove that our control schemes, constant fuel utilization control and constant voltage control based on MPC, are valid.

## REFERENCES

- [1] W. Sangtongkitcharoen, S. Vivanpatarakij, et al., Chem. Eng. J. 138 (2008) 436.
- [2] D.J. Hall, R.G. Colclaser, IEEE Trans. Energy Convers. 14 (1999) 749.
- [3] C. Wang, M. Hashem Nehrir, IEEE Trans. Energy Convers. 22 (2007) 887.
- [4] A. Selimovic, M. Kemm, et al., Journal Power Sources 145 (2005) 463.
- [5] H.H. Huo, X.J. Zhu, et al., Journal Power Sources 185 (2008) 338.
- [6] X.J. Wu, X.J. Zhu et al., Journal Power Sources 179 (2008) 232.
- [7] M. Verhaegen, Chemical Engineering Communications, 163 (1998) 111.
- [8] E. Eskinat, S.H. Johnson, and W.L. Luyben, AIChE Journal, 37 (1991) 255.
- [9] S. J. Norquay, A. Palazoglu, and J.A. Romagnoli, IEEE Trans. Control Systems Tech. 7 (1999) 437.
- [10] M.V. Kothare, V. Balakrishnan, and M. Morari, Automatica, vol. 32 (1996) 1361.
- [11] J.B. Rawlings, K.R. Muske, IEEE Trans. Automat. Contr. 38 (1993) 1512.
- [12] M.J. Kim, W.H. Kwon, et al., Journal of Guidance, Control, and Dynamics, 20 (1997).
- [13] W. Wang, and R. Hendriksen, Modeling, Identification and Control, 15 (1994) 253.
- [14] S. Gerksic, D. Juricic, et al., International Journal of Systems Science, 31 (2000) 189.
- [15] S.J. Norquay, A. Palazoglu, and J.A. Romagnoli, Chemical Engineering Science, 53 (1998) 75.
- [16] C. Wang, M.H. Nehrir, IEEE Trans. Energy Convers. 22 (2007) 887.
- [17] C. Wang, M.H. Nehrir, IEEE Trans. Energy Convers. 22 (2007) 898.
- [18] S.M. Lee, D.H. Lee, S.C. Won, SICE Annual Conference in Fukui, August 4-6 (2003).
- [19] S.J. Norquay, A. Palazoglu, and J.A. Romagnoli, Chemical Engineering Science, 53 (1998) 75.
- [20] <http://www.coe.montana.edu/ee/fuelcell/>