

# A Study on Leaching Behavior of Na, Ca and K Using Column Leach Test

Barman P.J, Kartha S A, Gupta S, and Pradhan B.

**Abstract**—Column leach test has been performed to examine the behavior of leaching of sodium, calcium and potassium in landfills. In the column leach apparatus, two different layers of contaminated and uncontaminated soils of different height ratios (ratio of depth of contaminated soil to the depth of uncontaminated soil) are taken. Water is poured from an overhead tank at a particular flowrate to the inlet of the soil column for a certain ponding depth over the contaminated soil. Subsequent infiltration causes leaching and the leachates are collected from the bottom of the column. The concentrations of Na, Ca and K in the leachate are measured using flame photometry. The experiments are further extended by changing the rates of flow from the overhead tank to the inlet of the column in achieving the same ponding depth. The experiments are performed for different scenarios in which the height ratios are altered and the variations of concentrations of Na, Ca, and K are observed. The study brings an estimation of leaching in landfill sites for different heights and precipitation intensity where a ponding depth is maintained over the landfill. It has been observed that the leaching behavior of Na, Ca, and K are not similar. Calcium exhibits highest amount of leaching compared to Sodium and Potassium under similar experimental conditions.

**Keywords**—Column leaching, flow rate, uncontaminated soil, contaminated soil, concentration, height ratio.

## I. INTRODUCTION

GROUNDWATER pollution has become a burning problem all over the world. Groundwater gets contaminated in many ways. If rain water or surface water comes into contact with contaminated soil while seeping into the ground, it can be polluted and the contaminants may leach from the soil to the groundwater. Many measures have been taken to prevent this type of pollution. The industrial waste materials usually contain large amount of chemicals and heavy metals that are dumped on the surface as waste landfills. Percolation of water during rainfall and surface runoff, etc. causes leaching of these heavy metals into the subsurface environment. This groundwater pollution also results in the disturbance of ecosystem. Many studies are carried out in various parts of the world to study the mechanism of leaching in subsurface hydro systems. Various models were developed to quantify and describe leaching.

Barman P.J. is with the Indian Institute of Technology Guwahati (phone: 91-361-2584174; fax: 91-361-2582440; e-mail: pjb@iitg.ernet.in).

Gupta S. with the Indian School of Mines Guwahati (e-mail: sunny.gupta.ism@gmail.com).

Kartha S A. is with the Indian Institute of Technology Guwahati (phone: 91-361-2582422; fax: 91-361-2582440; e-mail: kartha@iitg.ernet.in).

Pradhan B. is with the Indian Institute of Technology Guwahati (phone: 91-361-2582425; fax: 91-361-2582440; e-mail: bulu@iitg.ernet.in).

[1] Carried out an experimental investigation using three lysimeters to determine the leaching potential of heavy metals from landfill site under co disposal condition with e-waste. [2] Presented a two dimensional solute transport model of acid leaching of copper using sulphuric acid as the leaching agent. These experiments enabled to determine the hydraulic dispersion and reaction parameters. They validated the experimental results by comparison with numerical analysis. [3] Carried out laboratory column experiments to determine the leaching of 2, 4-Dichlorophenoxyacetic acid through soil columns. [4] Carried out a study to evaluate the effect of different column contact times on the release of inorganic constituents from bottom ash and demolition waste. It was observed that variations in contact time have no significant effect on the release of the selected constituents and leaching parameters at low liquid to solid ratios. [5] presented a leaching model for cementitious materials where the purpose of research was to evaluate the long-term durability of engineered barrier materials used in underground radioactive waste disposal facilities.[6] have carried out column leach test and batch release experiments using modified montmorillonites to reduce herbicide leaching in sports turf surfaces. [7] Have performed column percolation experiment for municipality solid waste incineration bottom ash. [8] Carried out a study on determination of leaching of polycyclic aromatic hydrocarbons. [9] Carried out an experimental investigation to determine the influence of soluble organic matter from municipality solid waste compost on trace metal leaching in calcareous soil. It was observed that majority of water soluble metals like cadmium, lead, and zinc from municipality waste accumulated in the top soil except nickel. [10] Carried out both toxicity characteristic leaching test and synthetic characteristic leaching test to determine the potential impact of loss of metals from treated wood. It was observed that ammonia is one of the major factors in the leaching of heavy metals from the treated wood. [11] carried out experimental investigation as well as computational modeling of unsaturated flow of liquid in heap leaching where the results from the numerical modeling are in good agreement with those from experimental procedure.[12] carried out batch leaching test as well as column leach test to determine the contents of heavy metals spent in household batteries. The experimental result showed that amount of leaching is more at low pH than at higher pH. It indicates with increasing amount of batteries disposed in the landfill there is greater risk of leaching of Zinc and magnesium. [13] Zhebin and Shuman (1996) carried out leaching test in soil column to determine the mobility of Zinc Cadmium and lead in soils affected by

poultry litter extracts. It was observed that application of poultry litter in metal contaminated soil may increase the movement of Zinc and Cadmium in soil. [14] Basta and McGowan (2003) carried out solute transport experiment with agricultural limestone, mineral rock phosphate and diammonium phosphate to determine their ability for reducing heavy metal transport in a smelter-contaminated soil. It was observed that diammonium phosphate was the most effective treatment for immobilizing heavy metals.

By all these reviews, it has been observed that numerous attempts have been made to study the effect of leaching behavior in soil by experimental investigation. However there are many other biochemical parameters that affect the process of leaching behavior and are responsible for groundwater contamination. Column leaching experiments have been conducted to analyze the pattern of leaching by varying these different parameters. The experimental setup is shown below in figure 1:

## II. EXPERIMENTAL PROGRAM

### Experimental Setup:

Column leaching test have been performed in the 3 different columns having different height ratios, which is defined as the ratio of height of the contaminated soil to the height of the uncontaminated soil. The experimental setup for these 3 different height ratios is defined below in figure 1:

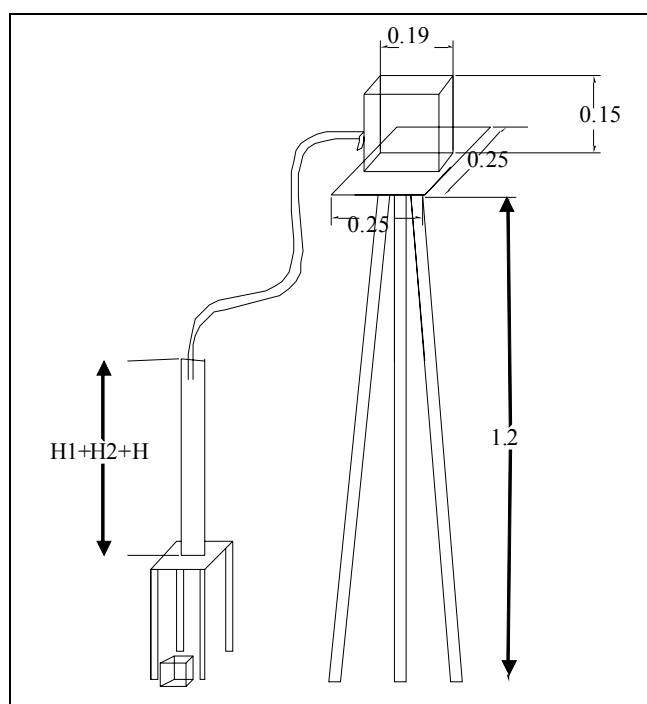

Fig. 1 Column leach apparatus (All dimensions are in meter)

Total height of column has 3 different parts as:

H1: Height of the uncontaminated soil layer.

H2: Height of the contaminated soil layer.

H: Height of the water layer above the soil layer which may be termed as ponding depth.

Also, three different columns have been made having different height ratios that are specified in the table below:

TABLE I  
 VARIOUS HEIGHTS OF SOIL TAKEN IN THE COLUMN LEACH APPARATUS

Column	H <sub>1</sub> = Height of uncontaminated soil (cm)	H <sub>2</sub> = Height of contaminated soil(cm)	H= Height of water in column or ponding depth(cm)	Total Height of column (cm)
Column 1	6	8	6	20
Column 2	15	5	10	30
Column 3	18	3	9	30

Here, uncontaminated soil has been filled first in the column at a specific height and then contaminated soil is filled to the desired height. Flow rate is controlled by the water tank which is fitted with a regulatory mechanism to control the flow rate. The column is placed on an iron stand and beakers have been kept beneath the column for collection of leachate. Here, three different flow rates have been taken into account i.e. 50 ml/sec, 100ml/sec and 150 ml/sec. The ponding depth is gradually increased with the increase in the column height. The ratio of base layer height to the ponding depth is gradually increased as 1, 1.5 and 2 for Column1, Column2 and Column3 respectively.

## III. PROCEDURE

In the experimental setup, contaminated soil samples are collected from the landfill site of Guwahati city which is situated in the northeast part of India. Uncontaminated soil samples are taken from the nearby area. Uncontaminated soil has been filled as a base soil in the column over which contaminated soil has been placed. Like this, three columns of different height ratios have been made. Water is poured from the inlet of the overhead tank at specified flowrate of 50ml/sec, 100 ml/sec and 150 ml/ sec sequentially on the same soil column maintaining a ponding depth each time as specified in the above table.

Further, water is poured from the top of the each column at 100ml/sec, 50 ml/sec and 150 ml/sec. Leachate is collected from the bottom of each column at a regular interval of 10 minute. Leachates were analysed for the concentration of sodium, calcium and potassium by flame photometer and further, the change in variation of leaching for each height ratios is concluded in the study.

## IV. RESULTS AND DISCUSSION

For three flow rates as 50ml/sec, 100 ml/sec and 150 ml/sec, leachate has been taken from each column. For a specific flow rate of the inlet water and a certain ponding depth leachate from three columns of different height ratios have been taken and analysed for their concentration of sodium, calcium and potassium.

Below, specified is the calculated result for the concentration of sodium, calcium and potassium in each column. The experiment is conducted for three flowrates 50 ml/sec, 100 ml/sec and 150 ml/sec sequentially on the same soil to simulate realistic field scenario. A ponding depth is maintained which is mentioned in the above table.

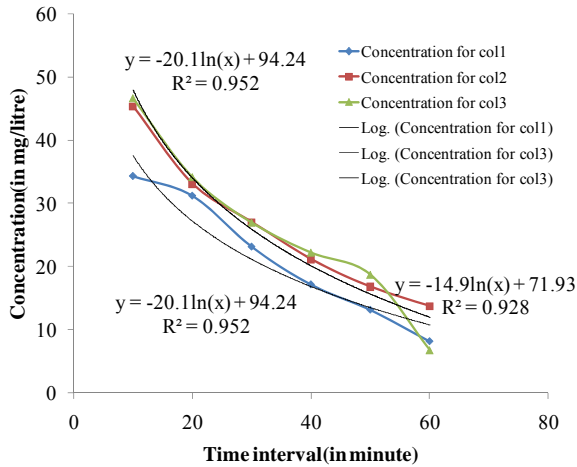

Fig. 2 Plot of Concentration vs. time graph for sodium at flow rate 100 ml/sec for 3 columns. Height ratio H2/H1 for 3 columns are= 8/6, 5/15, 3/18

It is observed from figure 2 that the rate of leaching decreases with time. An approximate logarithmic relationship between leached concentration vs time may be fitted as shown in figure 2.

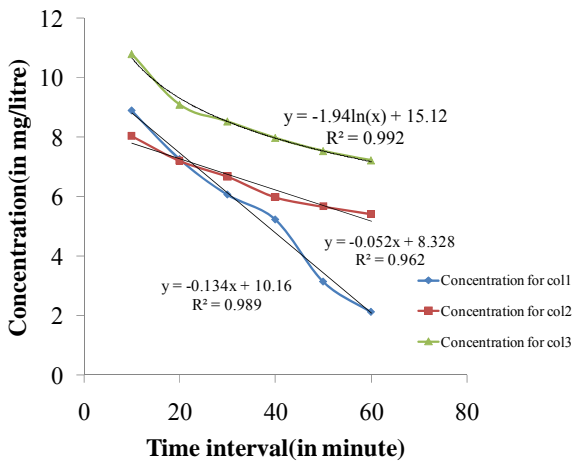

Fig. 3 Plot of Concentration vs time graph for Sodium at flow rate 50 ml/sec for 3 columns. Height ratio H2/H1 for 3 columns are= 8/6, 5/15, 3/18

It is observed from figure 3 that gradual decrease in leached concentration is observed in all the cases. From the figures it has been observed that due to the leaching action in the earlier cases gradual decrease in leached concentration is observed the pattern of decrease in leached concentration follows an approximate logarithmic relationship which is shown in the above figure.

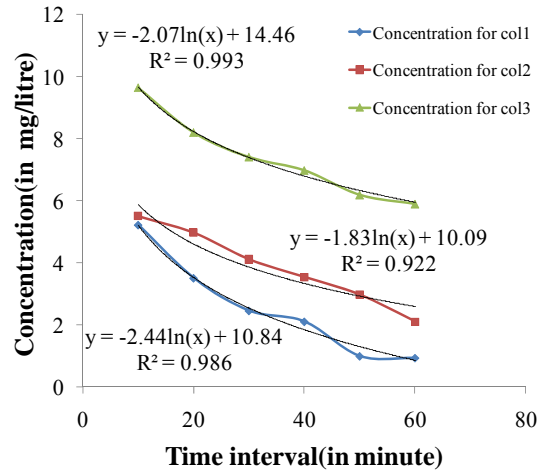

Fig. 4 Plot of Concentration vs time graph for sodium at flow rate 150 ml/sec for 3 columns. Height ratio H2/H1 for 3 columns are= 8/6, 5/15, 3/18

From figure 4 it is observed that when the flowrate is 150ml/sec very less amount of Sodium is observed in the leached concentration. Due to earlier two experiments significant amount of Sodium has already leached. However in all the cases the leaching behavior follows an approximate logarithmic relationship as shown in the figure above.

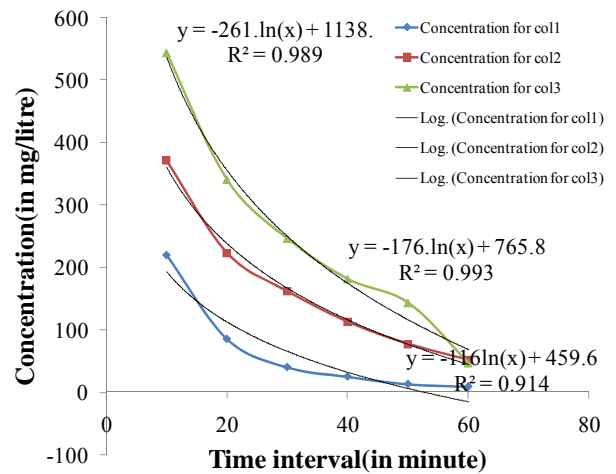

Fig. 5 Plot of Concentration vs. time graph for calcium at flow rate 100 ml/sec for 3 columns. Height ratio H2/H1 for 3 columns are= 8/6, 5/15, 3/18

It is observed from figure 5 that in comparison with Sodium, leached concentration of Calcium is observed to be more for the same time intervals. In all the cases the pattern of leached concentration shows a regular pattern of decrease which may be fitted with the logarithmic relationships as shown in figure 5.

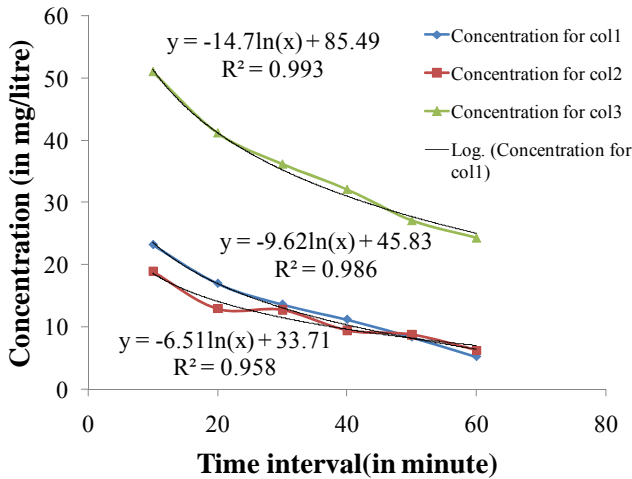

Fig. 6 Plot of Concentration vs time graph for calcium at flow rate 50 ml/sec for 3 columns. Height ratio H2/H1 for 3 columns are= 8/6, 5/15, 3/18

It is observed from figure 6 that gradual decrease in leached concentration is observed in all the cases. The pattern of variation may be fitted with logarithmic relationships as shown in figure 6.

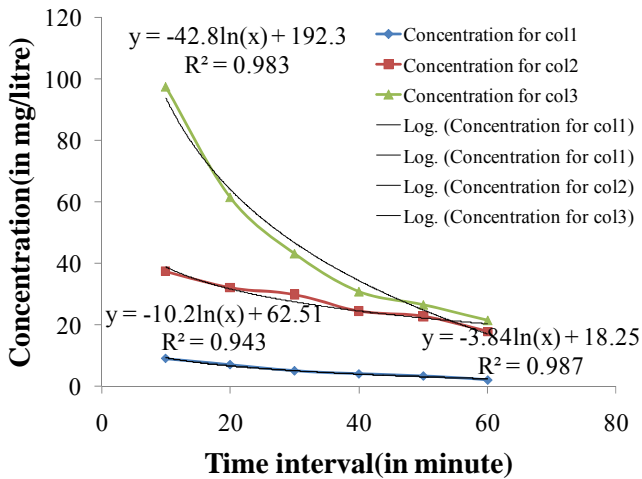

Fig. 7 Plot of Concentration vs. time graph for calcium at flow rate 150 ml/sec for 3 columns. Height ratio H2/H1 for 3 columns are= 8/6, 5/15, 3/18

From figure 7 it is observed that when the rate of inlet water is high i.e. 150 ml/sec the leached concentration in all the columns are observed to be slightly greater than the earlier case i.e. 50 ml/sec. Logarithmic relationship between leached concentration vs time with R2 value is shown above.

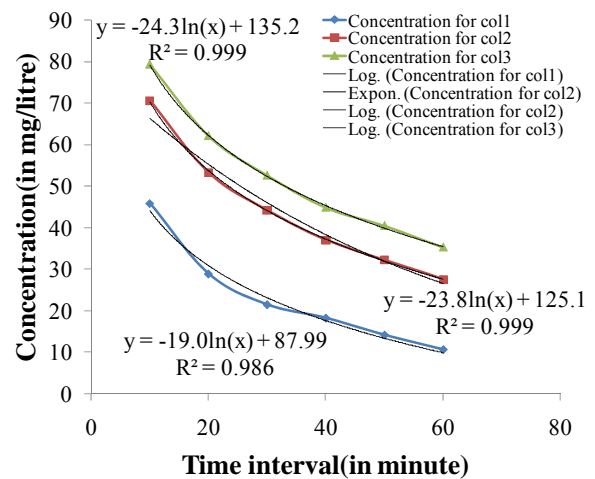

Fig. 8 Plot of Concentration vs. time graph for Potassium at flow rate 100 ml/sec for 3 columns. Height ratio H2/H1 for 3 columns are= 8/6, 5/15, 3/18.

From figure 8 it is observed that at low flow rate of the inlet water all the three columns exhibit a regular pattern of decrease. However compared to Sodium, Potassium exhibits more leaching behavior. The pattern of decrease may be fitted with logarithmic relationship as shown in the above figure.

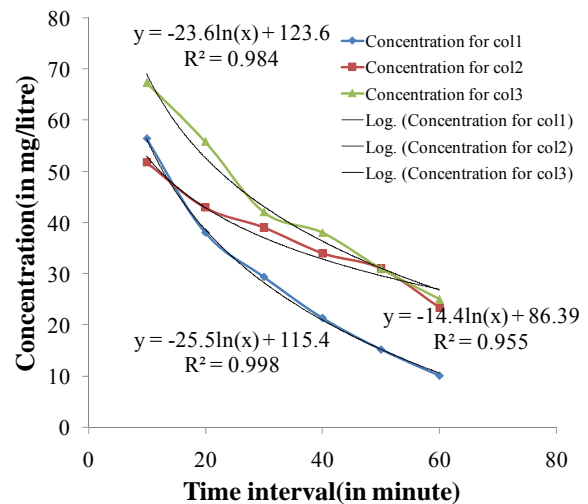

Fig. 9 Plot of Concentration vs. time graph for potassium at flow rate 50 ml/sec for 3 columns. Height ratio H2/H1 for 3 columns are= 8/6, 5/15, 3/18

From figure 9 it is observed that with the decrease in inflow rate from 100 ml/sec to 50ml/sec there is gradual decrease in the leached behavior in all the three columns. The logarithmic relationship for the variation is shown in the figure 9.

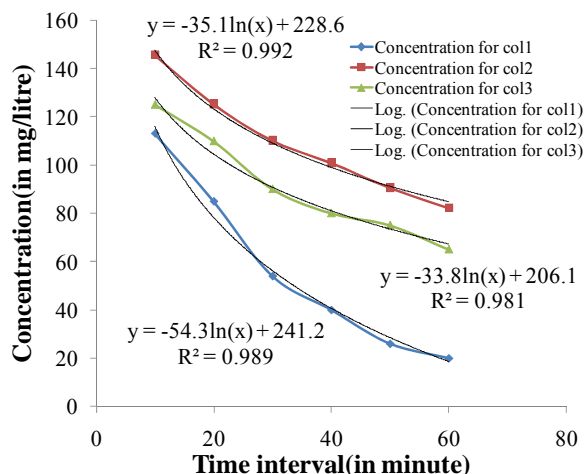

Fig. 10 Plot of Concentration vs time graph for potassium at flow rate 150 ml/sec for 3 columns. Height ratio H2/H1 for 3 columns are= 8/6, 5/15, 3/18

From figure 10 it is observed that at a high inflow rate of 150 ml/sec there is slight increase in the leached behavior compared to the earlier case. The pattern of variation is observed to be nonlinear which may be fitted within approximate logarithmic relationships as shown in the figure above.

#### V. CONCLUSION

1. The leaching behavior of Na, Ca, and K are not similar.
2. Calcium exhibits more amount of leaching compared to Na and K under similar experimental conditions.
3. The decrease in leached concentration with time follows an approximate logarithmic pattern of variation.

#### REFERENCES

- [1] Vismanthan C, Yin N H, Karthikeyan O.P.). "Co-disposal of electronic waste with municipal solid waste in bioreactor landfills", *Waste Management vol.30*, 2004 pp. 2608-2614.
- [2] Munoz J F, Rengifo P and Vauclin M "Acid leaching of copper in a saturated porous material: Parameter identification and experimental validation of a two dimensional transport model" *Journal of contaminant hydrology vol.28*, pp. 1853-1867,1997.
- [3] Morillo E, Martinez J.I.P and Gines J.M "Leaching of 2,4 D from a soil in presence of  $\beta$ -cyclodextrin: laboratory column experiments". *Chemosphere* 44, pp. 1065-1069, 2001.
- [4] Meza S L, Kalbe U, Berger W, Simon F G "Effect of contact time on release of contaminants from granular waste materials during column leaching experiments". *Waste Management* 30,565-571, 2010.
- [5] Yokozeki.K, Watanabe K, Sakata N and Otsuki N "Modeling of leaching from cementations materials used in underground environment" *Applied Clay science vol.26*, 293-308,2004.
- [6] Comejo L, Celis R, Dominguez C, Hermosin M.C. and Comejo J. "Use of modified montmorillonites to reduce herbicide leaching in sports turf surfaces: Laboratory and field experiments" *Applied Clay Science* 42, 284-291, 2007.
- [7] Hyks J and Astrup T "Influence of operational conditions, waste input and ageing on contaminant leaching from waste incinerator bottom ash: A full-scale study". *Chemosphere* 76, 1178-1184, 2009.
- [8] Enell A, Reichenberg F, Warfvinge P and Ewald G. "A column method for determination of leaching of polycyclic aromatic hydrocarbons from aged contaminated soil". *Chemosphere* 54, pp707-715, 2003.

- [9] Kaschl A, Romheld V, Chen Y "The influence of soluble organic matter from municipal solid waste compost on trace metal leaching in calcareous soils" *The Science of the Total Environment* vol.291 ,pp. 45-57.
- [10] Dubey B, Townshend T, Gabriele H.S. "Metal loss from treated wood products in contact with municipal solid wasteland fills leachate". *Journal of Contaminant Hydrology*, Vol. 23, Issue 4, August 329-345,2010.
- [11] Sheikhzadeh G.A, Mehrabian M.A, Mansouri S.H and Sarraf A. "Computational modeling of unsaturated flow in liquid in heap leaching- using the results of column tests to calibrate the model". *International Journal of Heat and Mass Transfer* 48 , 279-292,2004.
- [12] Karnchanawong S, Limpiteeprakan P "Evaluation of heavy metal leaching from spent household batteries disposed in municipal solid waste" *Waste Management* ,550-558,2009.
- [13] Li Z, Shuman L M. "Mobility of Zn,Cd and Pb in soils as effected by poultry litter extract-I Leaching in soil columns" *Environmental pollution* Vol 95, No2 pp 219-226,1996.
- [14] Basta N T, McGowan S L "Evaluation of chemical immobilization treatment for reducing heavy metal transport in a smelter contaminated soil" *Environmental Pollution* vol 127,pp. 73-82,2003.