

Simulation of Lightning Surge Propagation in Transmission Lines Using the FDTD Method

Kokiat Aodsup and Thanatchai Kulworawanichpong

Abstract— This paper describes a finite-difference time-domain (FDTD) method to analyze lightning surge propagation in electric power transmission lines. Numerical computation of solving the Telegraphist's equations is determined and investigated its effectiveness. A source of lightning surge wave on power transmission lines is modeled by using Heidler's surge model. The proposed method was tested against medium-voltage power transmission lines in comparison with the solution obtained by using Bewley lattice diagram. As a result, the calculation showed that the FDTD method is one of accurate methods to analyze transient lightning wave in power transmission lines.

Keywords— Finite-difference time-domain (FDTD) method, Traveling wave, Lightning surge, Bewley lattice diagram, Telegraphist's equations.

I. INTRODUCTION

LIGHTNING and switching surges can occur occasionally in electric power transmission lines. These phenomena can produce high voltage level in a very short time that can damage insulation or can cause server flashover [1-3]. Lightning surge may be caused by either direct strokes or by the fields radiated from distant lightning, called indirect strokes. Direct lightning strokes are determined as a serious problem but it rarely occurs. However, indirect strokes, in fact they are less severe than direct strokes, may be a significant problem because of their frequent occurrence. The induced lightning surges can cause significant damages to electric power components, telecommunication equipment, computer networks, etc. These result in severe damages of equipment, interruption of services, increased operation and maintenance cost. Therefore, adequate lightning or surge protection of electrical and electronic systems from electromagnetic disturbances has been increasingly important. For insulation design of the power transmission system, it is vital to exhibit the induced voltage behaviors propagated along the transmission lines. Consequently, both theoretical and experimental studies of lightning induced electromagnetic fields have been conducted continuously in over half a century.

Numerical simulation plays an important role for theoretical studies of electromagnetic problems because of the complex nature of the electromagnetic waves. A close interaction

between theory and practical works is crucial for every developing research field. Numerical computation of lightning surge propagation in power transmission line resulting from either direct or indirect lightning strokes is very important to know various aspects of the problems and equally important in developing protection schemes against such an atmospheric phenomena [4].

In theory, characteristics of lightning surge propagation in transmission lines can be described mathematically in forms of partial differential equations (PDEs) as the well-known Telegraphist's equations [5]. These equations are linear second-order partial differential equations with constant coefficients. These equations fall into three basic categories: parabolic, elliptic and hyperbolic. In case of lossless lines where series resistance of lines and shunt conductance representing insulation losses are neglected, the system equations can be simplified into the wave equations which the lightning surge can propagate along the line without any line attenuation. Although the wave equations as hyperbolic PDEs have an exact equations in some circumstances, further investigation such as appearance of lightning surge arresters somewhere in transmission lines can raise complexity and nonlinearity in the governing system equations. Solutions of these equations were obtained several decades ago by Heaviside in England and Poincare in France [2]. The FDTD method [6-8] is basically a numerical tool and can be adapted in associating with surge arrester models in the future work.

This paper is well organized and separated into six sections. Section II gives a brief review of electric power transmission line and its mathematical model in such a way that lightning surge propagation is intended to be studied. Section III describes the FDTD method and its application in lightning surge propagation in transmission lines. For comparison, section IV devotes for a classical method of Bewley lattice diagram of wave reflection along transmission lines. Section V is for results and discussion. The final section is the conclusion remark.

II. POWER TRANSMISSION LINE MODELING

A. Mathematical Model of a Power Transmission Line

The study of transmission line surges regardless of their origin is very complex. Although the long-line model is recommended for lines more than approximately 150 mi long [9], the lightning surge wave propagation is a very short-time impulse wave-shape therefore the long-line model is a good representation of power lines for a high-frequency impulse of

Kokiat Aodsup is with the School of Electrical Engineering, Institute of Engineering, Suranaree University of Technology, Nakhon Ratchasima, THAILAND 30000 (e-mail: kokiat_a@hotmail.co.th.)

Thanatchai Kulworawanichpong is with the School of Electrical Engineering, Institute of Engineering, Suranaree University of Technology, Nakhon Ratchasima, THAILAND 30000 (e-mail: thanatch@sut.ac.th)

lightning surges.

Fig. 1 shows the frame and the equivalent circuit of a very small section of a single-phase power transmission line. Assuming that the line conductors are parallel to the ground

and uniformly distributed, the time-domain characteristics in form of partial differential equations of the single-conductor line can be expressed as follows.

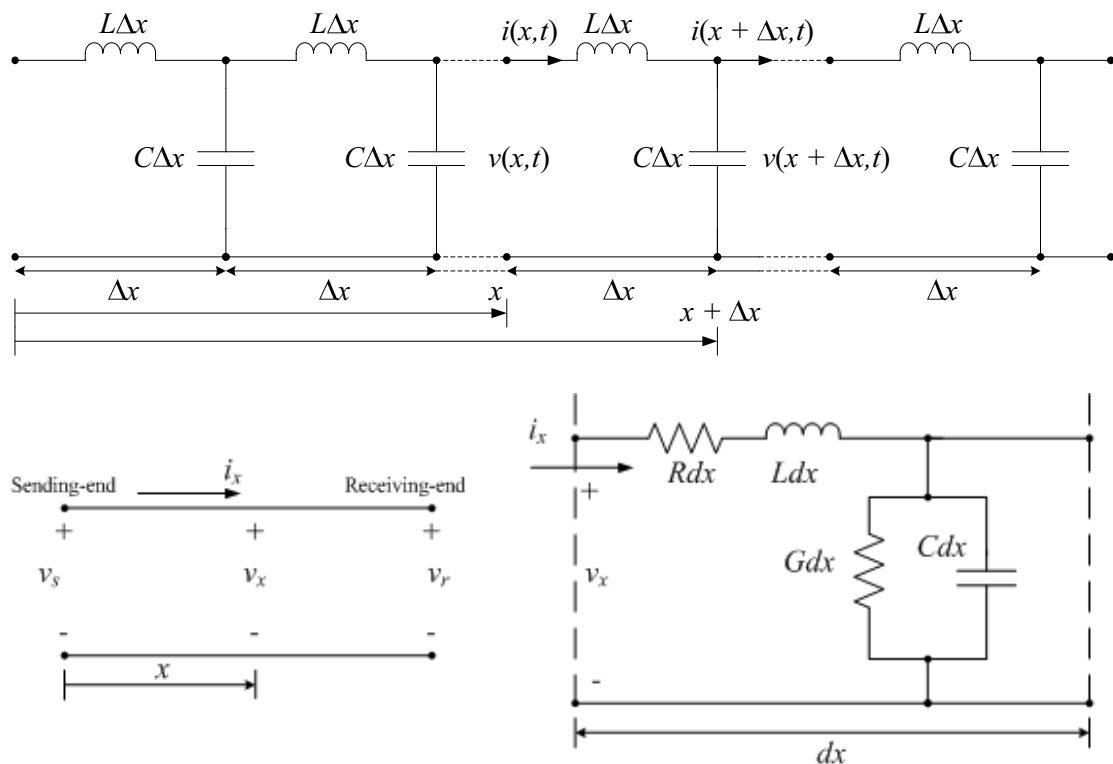

Fig. 1 Distributed line model for power transmission line wave propagation

$$\frac{d}{dx} v(x,t) = -Ri(x,t) - L \frac{d}{dt} v(x,t) \quad (1)$$

$$\frac{d}{dx} i(x,t) = -Gv(x,t) - C \frac{d}{dt} i(x,t) \quad (2)$$

time so that they are in form of partial derivatives. Since it assumes that the transmission line is a lossless line, R and G will be equal to zero to give the following expressions.

$$\frac{d}{dx} v(x,t) = -L \frac{d}{dt} v(x,t) \quad (3)$$

$$\frac{d}{dx} i(x,t) = -C \frac{d}{dt} i(x,t) \quad (4)$$

Where $i(x,t)$ is a current surge wave function
 $v(x,t)$ is a voltage surge wave function
 R, L, C and G are per-unit length line parameters

Consider the distance x along the transmission line from the sending end (rather than the receiving end) to the very small different element of length dx shown in the above figure. The voltage $v(x,t)$ and current $i(x,t)$ are both a function of space and

A set of the above equations is also called wave equations. Now either current $i(x,t)$ can be eliminated by taking the partial derivatives of both terms in (3) with respect to x and in (4) with respect to t , or voltage $v(x,t)$ can be eliminated by taking

the partial derivatives of both terms in (3) with respect to t and in (4) with respect to x . This will produce a linear second-order partial differential equation in form of hyperbolic PDEs as shown in (5) for the voltage wave equation.

$$\frac{1}{LC} \frac{d^2}{dx^2} v(x,t) = \frac{d^2}{dt^2} v(x,t) \quad (5)$$

Solving the above so-called “travelling wave equation” has a long history. In the mid of the previous century where computer was not efficient, the classical reflection analysis of traveling wave through the line junction was the only potential tool to do so. This method is widely known and broadly accepted as a preliminary tool of study in wave propagation in power transmission lines. It is called “Bewley lattice diagram”. It enables the calculation of wave refraction and reflection and any line junctions. This method will be reviewed in the next section.

B. Heidler’s Surge Function

The lightning surge wave model for the wave propagation model or the RLC lightning model is represented as an impulse source occurring on somewhere in a transmission line. The solutions for the line voltage and line current are obtained by solving the Telegrapher’s equations. In the model, the surge voltage distribution is obtained by taking into account the voltage waves propagate along the line channel with velocity v and the same wave shape. The propagation velocity u is less than the speed of light (usually $1/3 - 2/3$ the speed of light). The model based on the travelling-wave source was introduced by Heidler [10] in which the surge wave propagates at infinitely large speed while the return-stroke speed (front speed) is still finite. The equation for surge function introduced by Heidler satisfies the two basic requirements needed for the lightning surge simulation, i.e. the current does not have discontinuity at $t = 0$ s and the current derivative also does not have a discontinuity at $t = 0$ s provided that $k > 1$. At present time, Heidler representation of the lightning surge wave is one of the most widely-used surge model for the lightning surge propagation in transmission line. The Heidler’s surge function can be described by the following equation.

$$f(t) = \left(\frac{F_0}{\eta} \right) \left(1 - e^{-t/\tau_1} \right)^k e^{-t/\tau_2} \quad (6)$$

The waveform of the Heidler’s surge function as a current waveform in the range of $0 - 5 \mu\text{s}$ is shown in Fig. 2. The values of the parameters for plotting the Heidler current function are listed below.

- $F_0 = 10 \text{ kA}$
- $\eta = 1$
- $\tau_1 = 0.1 \mu\text{s}$
- $\tau_2 = 0.3 \mu\text{s}$
- $k = 2$

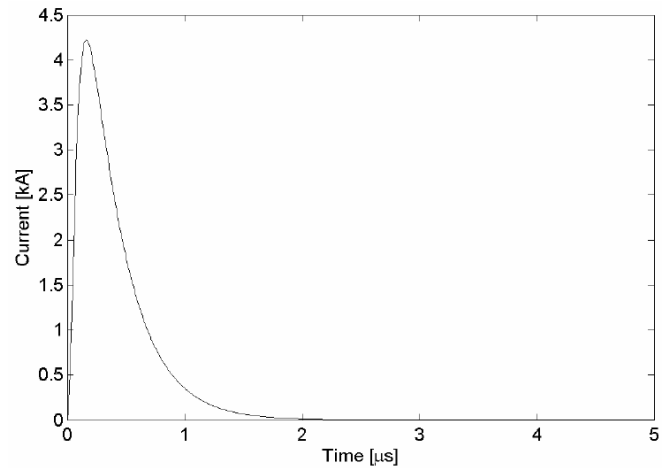

Fig. 2 Heidler’s current waveform based on (6)

III. TRANSIENT WAVE REFLECTION ANALYSIS

When a travelling wave on a transmission line reaches a transition point at which there is an abrupt change of line parameters, as open or short-circuit termination, a junction with another line, a machine winding, load termination, etc, a part of the wave is reflected back on the incoming line and the rest may pass through other line section. The travelling wave before reaching the transition point is called the incident wave. The incident wave may be decomposed into two component waves called the reflected wave and the transmitted wave. This relation is a voltage-wave solution of (5) and it can be expressed as in (7). The transmitted wave, $v''(x,t)$, is a wave portion travelling toward the next line section while the reflected wave, $v'(x,t)$, is a wave portion travelling backward to the source. These waves can be illustrated by the equivalent circuit shown in Fig. 3.

$$v(x,t) = v''(x,t) + v'(x,t) \quad (7)$$

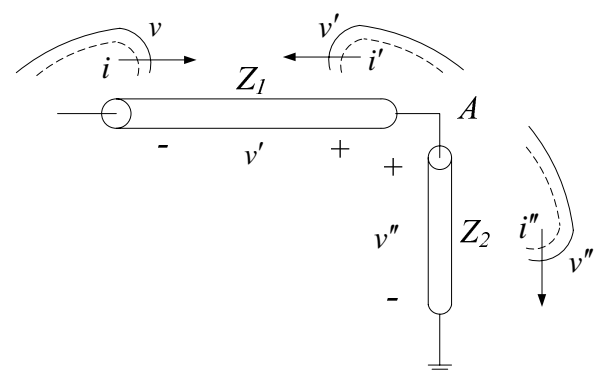

Fig. 3 Waves reflected and transmitted at the junction

If the line section # 1 has the surge impedance of Z_1 and the line section # 2 has the surge impedance of Z_2 , the transmitted and the reflected portions of the travelling wave can be represented in terms of the refraction coefficient β and the reflection coefficient α , respectively, as given in (8) and (9).

$$\beta = \frac{2Z_2}{Z_1 + Z_2} \quad (8)$$

$$\alpha = \frac{Z_2 - Z_1}{Z_1 + Z_2} \quad (9)$$

Where

$$Z_1 = \sqrt{\frac{L_1}{C_1}} \text{ and } Z_2 = \sqrt{\frac{L_2}{C_2}}$$

$$u_1 = \frac{1}{\sqrt{L_1 C_1}} \text{ is the wave speed of line 1}$$

$$u_2 = \frac{1}{\sqrt{L_2 C_2}} \text{ is the wave speed of line 2}$$

L_1 is per-unit inductance of line section 1
 L_2 is per-unit inductance of line section 2
 C_1 is per-unit capacitance of line section 1
 C_2 is per-unit capacitance of line section 2

In practical power network, many line sections are typical. This leads to multiple reflections among line junctions to exhibit complicated resulting waves. However, in a lateral line case, both the reflection and the refraction occur from the left to the right or from the right to the left, coefficients of reflection and refraction can be pre-calculated and then used repeatedly when any incident wave has arrived. The component waves calculated at any time and any position by using this pre-calculation of all coefficients at every junction can be drawn as the so-called "Bewley lattice diagram" [2] as illustrated in Fig. 4.

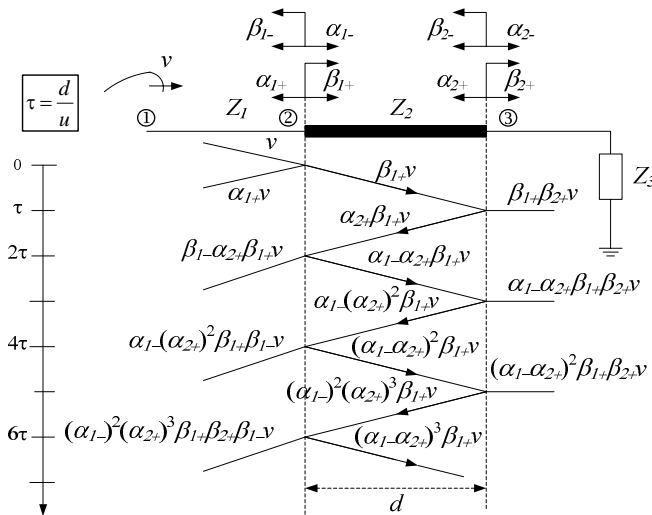

Fig. 4 Example of Bewley lattice diagram

IV. FINITE-DIFFERENCE TIME-DOMAIN (FDTD) METHOD

The standard example of a hyperbolic PDE is the one-dimensional wave equation as described follows.

$$c^2 \frac{d^2}{dx^2} v(x, t) = \frac{d^2}{dt^2} v(x, t) \quad (10)$$

Initial conditions are given for $v(x,0)$ and also its derivative. The boundary conditions are given at $x = 0$ and $x = L$ where L is the maximum limit of x .

According to the explicit method of solving the wave equation, replacing the space derivative in the wave equation by finite difference formula at the τ^{th} time step, (11) is obtained. In the same manner, replacing the time derivative by the finite difference formula at the λ^{th} space step, (12) is formed. By substituting (11) and (12) into (10), it gives the updated voltage wave solution as summarized in (13).

$$\frac{d^2}{dx^2} v(x, t) = \frac{v(\lambda + 1, \tau) - 2v(\lambda, \tau) + v(\lambda - 1, \tau)}{\Delta x^2} \quad (11)$$

$$\frac{d^2}{dt^2} v(x, t) = \frac{v(\lambda, \tau + 1) - 2v(\lambda, \tau) + v(\lambda, \tau - 1)}{\Delta t^2} \quad (12)$$

$$v(\lambda, \tau + 1) = \phi^2 v(\lambda - 1, \tau) + 2(1 - \phi^2) v(\lambda, \tau) + \phi^2 v(\lambda + 1, \tau) - v(\lambda, \tau - 1) \quad (13)$$

Where $\phi = c \frac{\Delta t}{\Delta x} = \frac{\Delta t}{\Delta x \sqrt{LC}}$ is the aspect ratio

V. SIMULATION RESULTS AND DISCUSSION

The study of successive reflection of travelling waves caused by either direct or indirect lightning stroke can be investigated through a test example of power transmission lines as shown in Fig. 5. This example consists of four transmission line sections with the open far-end. The line parameters of each section are given as follows.

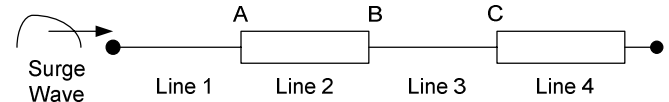

Fig. 5 The example transmission line systems

The parameter of transmission line systems is :

Line 1

Line length: 1 km
 $L_1 = 120 \mu\text{H/m}$, $C_1 = 10 \text{ pF/m}$

Line 2

Line length: 1 km
 $L_2 = 480 \mu\text{H/m}$, $C_2 = 10 \text{ pF/m}$

Line 3

Line length: 1 km
 $L_3 = 240 \mu\text{H/m}$, $C_3 = 10 \text{ pF/m}$

Line 4

Line length: 1 km
 $L_4 = 360 \mu\text{H/m}$, $C_4 = 10 \text{ pF/m}$

The Heidler's surge model of the lightning induced voltage can be characterized by the waveform in Fig. 6. The Heidler's surge wave has the 8.5-kV peak and 12/30- μs of the rise and decay time constants.

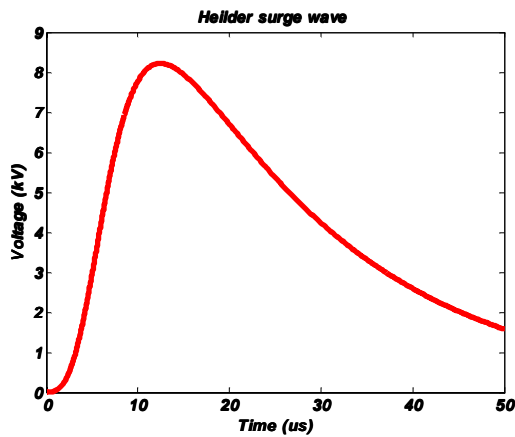

Fig. 6 Heilder's surge wave for the test example

With the help from MATLAB programming, lightning surge waves propagation on transmission lines can be simulated numerically. In this paper, this simulation used the time step of $0.5 \mu\text{s}$ and the step length of 5 m.

Assume that the lightning surge was induced at the sending end of the transmission line. The incident wave can travel along the line section 1 with a constant speed and without attenuation approach line junction A as shown in Fig. 7. After the incident wave hitting the junction, the incident wave of 8.5-kV peak was separated into the reflected wave of 3.5-kV peak and the transmitted wave of 12-kV peak. These two wave components can be depicted as shown in Fig. 8.

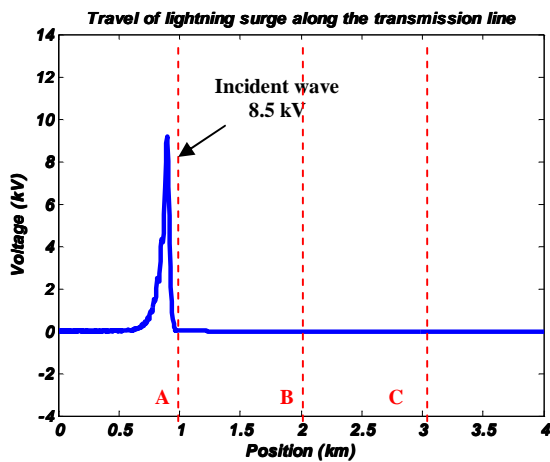

Fig. 7 Incident wave before arriving line junction A

The simulation had been carried out further by extending the propagation of the transmitted wave toward the line junction B. In this case, before the incident wave of 12-kV peak hitting the junction, the voltage in line section 3 is zero at all positions. After the incident wave hitting the junction, the incident wave of 12-kV peak was decomposed into the reflected wave of 4-kV peak (out-of-phase) and the transmitted wave of 8-kV peak penetrating deeply into the line section 4 as depicted in Fig. 9.

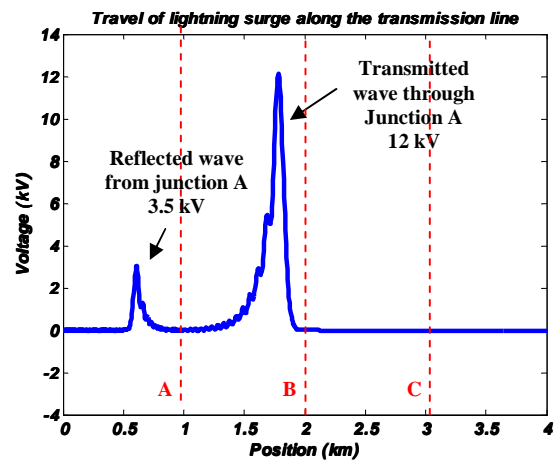

Fig. 8 Transmitted and reflected waves at junction A

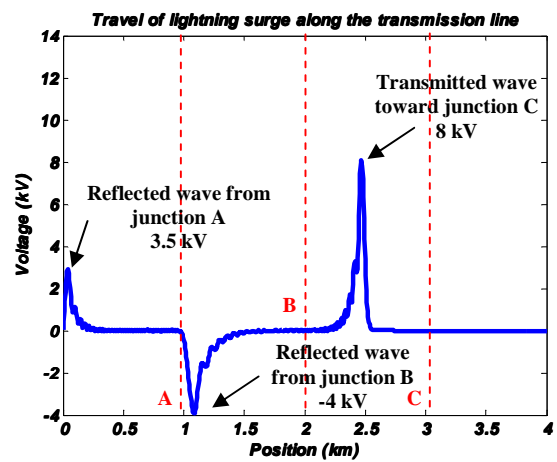

Fig. 9 Transmitted and reflected waves at junction B

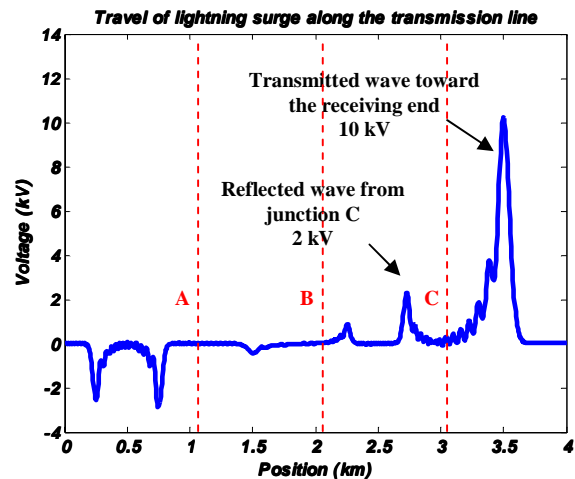

Fig. 10 Transmitted and reflected waves at junction C

The wave reflected from and transmitted through the line junction C can be exhibited as shown in Fig. 10. In this case, before the incident wave of 8-kV peak hitting the junction, the

voltage in line section 4 is zero at all positions. After the incident wave hitting the junction, the incident wave of 8-kV peak was split into the reflected wave of 2-kV peak and the transmitted wave of 10-kV peak penetrating toward the receiving end.

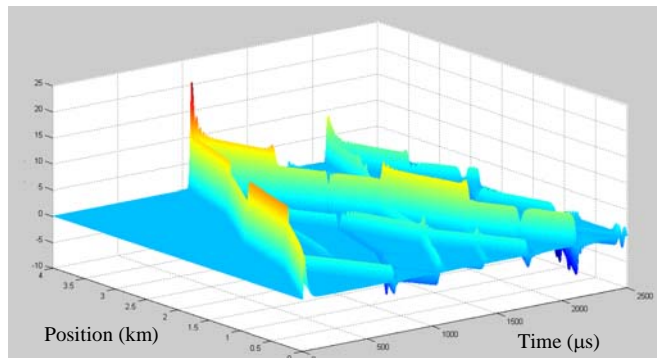

Fig. 11 Lightning surge propagation along the transmission lines of the test example after 2 ms

In addition, the full simulation of the whole system which consists of four line sections having a total of 4-km line length and the total time span of 2500 μs can be plotted in 3D surface as shown in Fig. 11.

VI. CONCLUSION

In this paper, the finite-difference time-domain (FDTD) method to analyze lightning surge propagation in electric power transmission lines has been presented. Numerical solutions for the Telegraphist's equations, in case of the wave equation were investigated its effectiveness in comparison with those obtained by using Bewley lattice diagram. A source of lightning surge wave on power transmission lines was modeled by using Heidler's surge model. The proposed method was tested against medium-voltage power transmission lines consisting of four line sections. As a result, the calculation showed that the effectiveness and the accuracy of the solutions obtained by the FDTD method are confirmed.

ACKNOWLEDGMENT

This work supported by Rajamangala University of Technology Lanna. The Scholarship for Ph.D. Program to Kokiatt Aodsup is acknowledged.

REFERENCES

- [1] J. A. Martinez-Velasco, *Power System Transients Parameter Determination*. CRC Press, 2010.
- [2] L. V. Bewley, *Travelling Waves on Transmission Systems*. Dover Publication, 1951.
- [3] A. R. Hileman, *Insulation Coordination for Power Systems*. Marcel Dekker, 1999.
- [4] Z. Benesova, and V. Kotlan, "Propagation of surge waves on non-homogeneous transmission lines induced by lightning stroke," *Advances in Electrical and Electronic Engineering*, Vol. 5, no. 1 – 2, pp. 198 – 203, 2006.
- [5] M. N. O. Sadiku, *Numerical Techniques in Electromagnetics*. CRC Press, 2001.

- [6] L. V. Fausett, *Applied Numerical Analysis using MATLAB*. Prentice-Hall, 1999.
- [7] S. C. Chapra, and R. P. Canale, *Numerical Method for Engineers*. McGraw-Hill, 2002.
- [8] C. A. Hall, and T. A. Porsching, *Numerical Analysis of Partial Differential Equations*. Prentice-Hall, 1990.
- [9] J. J. Granger, and W. D. Stephenson, *Power System Analysis*, McGraw-Hill, 1994.
- [10] F. Heidler, "Travelling current source model for LEMP calculation," in *Proc. 6th International Symposium on Electromagnetic Compatibility*, March 5-7, Zurich, Switzerland, 1985, pp. 157-162.