

MATLAB/SIMULINK Based Model of Single-Machine Infinite-Bus with TCSC for Stability Studies and Tuning Employing GA

Sidhartha Panda and Narayana Prasad Padhy

Abstract — With constraints on data availability and for study of power system stability it is adequate to model the synchronous generator with field circuit and one equivalent damper on q-axis known as the model 1.1. This paper presents a systematic procedure for modelling and simulation of a single-machine infinite-bus power system installed with a thyristor controlled series compensator (TCSC) where the synchronous generator is represented by model 1.1, so that impact of TCSC on power system stability can be more reasonably evaluated. The model of the example power system is developed using MATLAB/SIMULINK which can be used for teaching the power system stability phenomena, and also for research works especially to develop generator controllers using advanced technologies. Further, the parameters of the TCSC controller are optimized using genetic algorithm. The non-linear simulation results are presented to validate the effectiveness of the proposed approach.

Keywords—Genetic algorithm, MATLAB/SIMULINK, modelling and simulation, power system stability, single-machine infinite-bus power system, thyristor controlled series compensator.

NOMENCLATURE

δ	Rotor angle of synchronous generator in radians
ω_B	Rotor speed deviation in rad/sec
S_m	Generator slip in p.u.
S_{mo}	Initial operating slip in p.u.
H	Inertia constant
D	Damping coefficient
T_m	Mechanical power input in p.u.
T_e	Electrical power output in p.u.
E_{fd}	Excitation system voltage in p.u.
T'_{do}	Open circuit d-axis time constant in sec

Sidhartha Panda is a research scholar in the Department of Electrical Engineering, Indian Institute of Technology, Roorkee, Uttaranchal, 247667, India. (e-mail: speeddee@iitr.ernet.in, panda_sidhartha@rediffmail.com).

Narayana Prasad Padhy is Associate professor in the Department of Electrical Engineering, IIT, Roorkee India. (e-mail: nppeefee@iitr.ernet.in)

T'_{qo}	Open circuit q-axis time constant in sec
x_d	d-axis synchronous reactance in p.u.
x'_d	d-axis transient reactance in p.u.
x_q	q-axis synchronous reactance in p.u.
x'_q	q-axis transient reactance in p.u.
X_C	Nominal reactance of the fixed capacitor C
X_P	Inductive reactance of inductor L connected in parallel with C .
σ	Conduction angle of TCSC
α	Firing angle of TCSC
k	Compensation ratio, $k = \sqrt{X_C / X_P}$

I. INTRODUCTION

TRADITIONALLY, for the small signal stability studies of a single-machine infinite-bus (SMIB) power system, the linear model of Phillips-Heffron has been used for years, providing reliable results [1]-[2]. It has also been successfully used for designing and tuning the classical power system stabilizers (PSS). Although the model is a linear model, it is quite accurate for studying low frequency oscillations and stability of power systems. With the advent of Flexible AC Transmission System (FACTS) devices [3], such as thyristor controlled series compensator (TCSC), static synchronous compensator (STATCOM) and unified power flow controller (UPFC), the unified model of SMIB power system installed with a TCSC, STATCOM and a UPFC have been developed [4]-[6]. These models are the popular tools amongst power engineers for studying the dynamic behaviour of synchronous generators, with a view to design control equipment. However, the model only takes into account the generator main field winding and hence these models may not always yield a realistic dynamic assessment of the SMIB power system with FACTS because the generator damping winding in q-axis is not accounted for. Further, liner methods cannot properly capture complex dynamics of the system, especially during

major disturbances. This presents difficulties for designing the FACTS controllers in that, the controllers designed to provide desired performance at small signal condition do not guarantee acceptable performance in the event of major disturbances.

It is well known that the reactance adjusting of TCSC is a complex dynamic process. Effective design and accurate evaluation of the TCSC control strategy depend on the accuracy of modelling of this process. In [7], a systematic procedure for modeling, simulation and optimal tuning of TCSC controller in a SMIB power system was presented where the MATLAB/SIMULINK based model was developed and Genetic Algorithm (GA) was employed to design the TCSC controller. However, the model only takes into account the generator main field winding and the synchronous machine was represented by model (1.0). This paper presents a higher-order synchronous machine model, which includes one damper winding along the q-axis, for a power system installed with a TCSC.

Despite significant strides in the development of advanced control schemes over the past two decades, the conventional lead-lag (LL) structure controller as well as the classical proportional-integral-derivative (PID) controller and its variants, remain the controllers of choice in many industrial applications. These controller structures remain an engineer's preferred choice because of their structural simplicity, reliability, and the favorable ratio between performance and cost. Beyond these benefits, these controllers also offer simplified dynamic modeling, lower user-skill requirements, and minimal development effort, which are issues of substantial importance to engineering practice [8]-[9]. In [10], a comparative study about the TCSC based controller design was presented, where it has been shown that that LL structured TCSC controller with the controller parameters optimized using Integral of Time multiplied Absolute value of the Error (ITAE) as objective function, gives the best system response compared to all other alternatives. In view of the above, a LL controller structure is used for the TCSC controller.

The problem of TCSC controller parameter tuning is a complex exercise. A number of conventional techniques have been reported in the literature pertaining to design problems of conventional power system stabilizers namely: the eigenvalue assignment, mathematical programming, gradient procedure for optimization and also the modern control theory. Unfortunately, the conventional techniques are time consuming as they are iterative and require heavy computation burden and slow convergence. In addition, the search process is susceptible to be trapped in local minima and the solution obtained may not be optimal [11].

Genetic Algorithm (GA) is becoming popular for solving the optimisation problems in different fields of application, mainly because of their robustness in finding an optimal solution and ability to provide a near-optimal solution close to a global minimum. Unlike strict mathematical methods, the GA does not require the condition that the variables in the optimisation problem be continuous and different; it only requires that the problem to be solved can be computed. GA employs search procedures based on the mechanics of natural

selection and survival of the fittest. The GAs, which use a multiple-point instead of a single-point search and work with the coded structure of variables instead of the actual variables, require only the objective function, thereby making searching for a global optimum simpler [12]. Therefore, in the present work GA is employed to optimize the parameters of TCSC controller.

This paper is organized as follows. In Section II, the modeling of power system under study, which is a SMIB power system with a TCSC, is presented. The proposed controller structures and problem formulation are described in Section III. A short overview of GA is presented in Section IV. Simulation results are provided and discussed in Section V and conclusions are given in Section VI

II. POWER SYSTEM UNDER STUDY

The SMIB power system with TCSC shown in Fig. 1 is considered in this study. The synchronous generator is delivering power to the infinite-bus through a double circuit transmission line and a TCSC. In Fig. 1, V_t and E_b are the generator terminal and infinite bus voltage respectively; X_T , X_L and X_{TH} represent the reactance of the transformer, transmission line per circuit and the Thevenin's impedance of the receiving end system respectively.

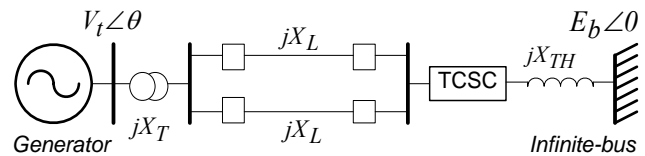

Fig. 1 Single-machine infinite-bus power system with TCSC

A. Modelling the Synchronous Generator Infinite-bus Power System

The synchronous generator is represented by model 1.1, i.e. with field circuit and one equivalent damper winding on q-axis. The machine equations are [13]:

$$\frac{d\delta}{dt} = \omega_B (S_m - S_{mo}) \quad (1)$$

$$\frac{dS_m}{dt} = \frac{1}{2H} [-D(S_m - S_{mo}) + T_m - T_e] \quad (2)$$

$$\frac{dE'_q}{dt} = \frac{1}{T'_{do}} [-E'_q + (x_d - x'_d) i_d + E_{fd}] \quad (3)$$

$$\frac{dE'_d}{dt} = \frac{1}{T'_{qo}} [-E'_d + (x_q - x'_q) i_q] \quad (4)$$

The electrical torque T_e is expressed in terms of variables E'_d , E'_q , i_d and i_q as:

$$T_e = E'_d i_d + E'_q i_q + (x'_d - x'_q) i_d i_q \quad (5)$$

For a lossless network, the stator algebraic equations and the network equations are expressed as:

$$E'_q + x'_d i_d = v_q \quad (6)$$

$$E'_d - x'_q i_q = v_d \quad (7)$$

$$v_q = -x_e i_d + E_b \cos \delta \quad (8)$$

$$v_d = x_e i_q - E_b \sin \delta \quad (9)$$

Solving the above equations, the variables i_d and i_q can be obtained as:

$$i_d = \frac{E_b \cos \delta - E'_q}{x_e + x'_d} \quad (10)$$

$$i_q = \frac{E_b \sin \delta + E'_d}{x_e + x'_q} \quad (11)$$

The above notation for the variables and parameters described are standard and defined in the nomenclature. For more details, the readers are suggested to refer [13]-[14].

B. Modelling the Thyristor Controlled Series Compensator (TCSC)

TCSC is one of the most important and best known series FACTS controllers. It has been in use for many years to increase line power transfer as well as to enhance system stability. The basic module of a TCSC is shown in Fig. 2. It consists of three components: capacitor banks C , bypass inductor L and bidirectional thyristors T_1 and T_2 . The firing angles of the thyristors are controlled to adjust the TCSC reactance in accordance with a system control algorithm, normally in response to some system parameter variations.

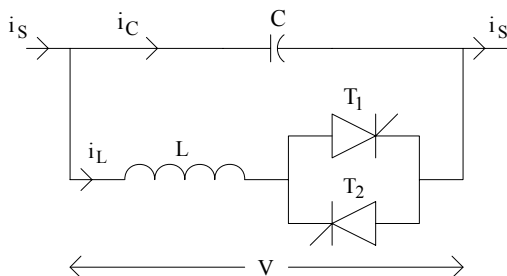

Fig. 2 Basic module of a TCSC

According to the variation of the thyristor firing angle (α) or conduction angle (σ), this process can be modelled as a fast switch between corresponding reactance offered to the power system. Assuming that the total current passing through the TCSC is sinusoidal; the equivalent reactance at the fundamental frequency can be represented as a variable reactance X_{TCSC} . There exists a steady-state relationship between α and the reactance X_{TCSC} . This relationship can be described by the following equation [15]:

$$X_{TCSC}(\alpha) = X_C - \frac{X_C^2}{(X_C - X_P)} \frac{(\sigma + \sin \sigma)}{\pi} + \frac{4X_C^2}{(X_C - X_P)} \frac{\cos^2(\sigma/2) [k \tan(k\sigma/2) - \tan(\sigma/2)]}{(k^2 - 1)\pi} \quad (12)$$

Since the relationship between α and the equivalent fundamental frequency reactance offered by TCSC, $X_{TCSC}(\alpha)$ is a unique-valued function, the TCSC is modeled here as a variable capacitive reactance within the operating region defined by the limits imposed by α . Thus $X_{TCSCmin} \leq X_{TCSC} \leq X_{TCSCmax}$, with $X_{TCSCmax} = X_{TCSC}(\alpha_{min})$ and $X_{TCSCmin} = X_{TCSC}(180^\circ) = X_C$. In this paper, the controller is assumed to operate only in the capacitive region, i.e., $\alpha_{min} > \alpha_r$ where α_r corresponds to the resonant point, as the inductive region associated with $90^\circ < \alpha < \alpha_r$ induces high harmonics that cannot be properly modeled in stability studies.

III. PROBLEM FORMULATION

A. Structure of the TCSC Controller

The structure of TCSC-based damping controller, to modulate the reactance offered by the TCSC, $X_{TCSC}(\alpha)$ is shown in Fig. 3. The input signal of the proposed controllers is the speed deviation ($\Delta\omega$), and the output signal is the reactance offered by the TCSC, $X_{TCSC}(\alpha)$. The structure consists of a gain block with gain K_T , a signal washout block and two-stage phase compensation blocks. The signal washout block serves as a high-pass filter, with the time constant T_{WT} , high enough to allow signals associated with oscillations in input signal to pass unchanged.

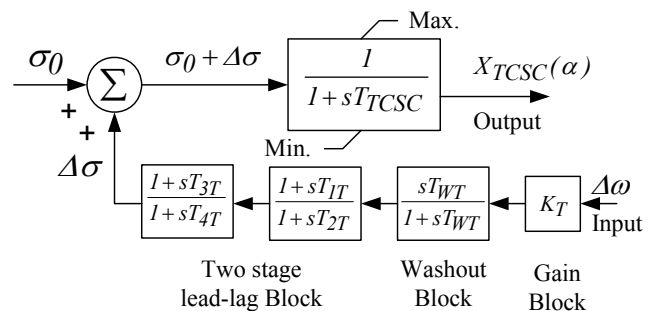

Fig. 3 Structure of TCSC-based controller

From the viewpoint of the washout function, the value of T_{WT} is not critical and may be in the range of 1 to 20 seconds [14]. The phase compensation block (time constants T_{1T} , T_{2T} and T_{3T} , T_{4T}) provides the appropriate phase-lead characteristics to compensate for the phase lag between input and the output signals. In the Fig. 3, σ_0 represents the initial conduction angle as desired by the power flow control loop. The steady state power flow loop acts quite slowly in practice and hence, in the present study, σ_0 is assumed to be constant during large disturbance transient period.

B. Problem Formulation

In the present study, a washout time constant of $T_{WT}=10s$ is used. The controller gain K_T and the time constants T_{1T} , T_{2T} , T_{3T} and T_{4T} are to be determined. During steady state conditions $\Delta\sigma$ and σ_0 are constant. During dynamic conditions, conduction angle (σ) and hence $X_{TCSC}(\alpha)$ is modulated to improve power system stability. The desired value of compensation is obtained through the change in the conduction angle ($\Delta\sigma$), according to the variation in $\Delta\omega$. The effective conduction angle σ during dynamic conditions is given by:

$$\sigma = \sigma_0 + \Delta\sigma \quad (13)$$

C. Objective Function

In this paper, an Integral of Time multiplied Absolute value of the Error (ITAE) is taken as the objective function [10]. The objective function is defined as follows:

$$J = \int_0^{t_{sim}} t |\Delta\omega(t)| dt \quad (14)$$

where, $\Delta\omega(t)$ is the speed deviation following a disturbance and t_{sim} is the time range of simulation.

IV. OVERVIEW OF GENETIC ALGORITHM (GA)

GA has been used for optimizing the parameters of the control system that are complex and difficult to solve by conventional optimisation methods. GA maintains a set of candidate solutions called population and repeatedly modifies them. At each step, the GA selects individuals from the current population to be parents and uses them to produce the children for the next generation. Candidate solutions are usually represented as strings of fixed length, called chromosomes. A fitness or objective function is used to reflect the goodness of each member of the population. Given a random initial population, GA operates in cycles called generations, as follows:

- Each member of the population is evaluated using a fitness function.
- The population undergoes reproduction in a number of iterations. One or more parents are chosen stochastically, but strings with higher fitness values have higher probability of contributing an offspring.

- Genetic operators, such as crossover and mutation, are applied to parents to produce offspring.
- The offspring are inserted into the population and the process is repeated.

The computational flow chart of the GA optimization approach followed in the present paper is shown in Fig. 5.

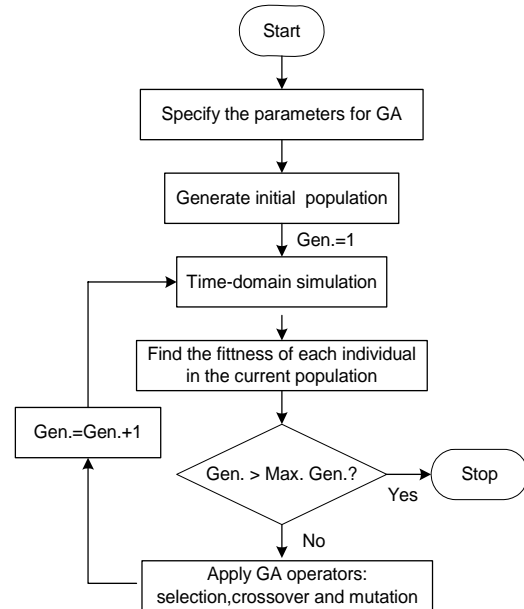

Fig. 4 Flowchart of the genetic algorithm

Tuning a controller parameter can be viewed as an optimization problem in multi-modal space as many settings of the controller could be yielding good performance. Traditional method of tuning doesn't guarantee optimal parameters and in most cases the tuned parameters needs improvement through trial and error. In GA based method, the tuning process is associated with an optimality concept through the defined objective function and the time domain simulation. The designer has the freedom to explicitly specify the required performance objectives in terms of time domain bounds on the closed loop responses. Hence the GA methods yield optimal parameters and the method is free from the curse of local optimality. In view of the above, the proposed approach employs GA to solve this optimization problem and search for optimal set of TCSC-based damping controller parameters.

V. RESULTS AND DISCUSSIONS

A. Application of GA Optimization Technique

In order to optimally tune the parameters of the TCSC-based controller, as well as to assess its performance and robustness under wide range of operating conditions with various fault disturbances and fault clearing sequences, the MATLAB/SIMULINK model of the example power system shown in Fig. 2 is developed using equations (2)–(19). The developed MATLAB/SIMULINK model of synchronous generator with TCSC is shown in Fig. 5.

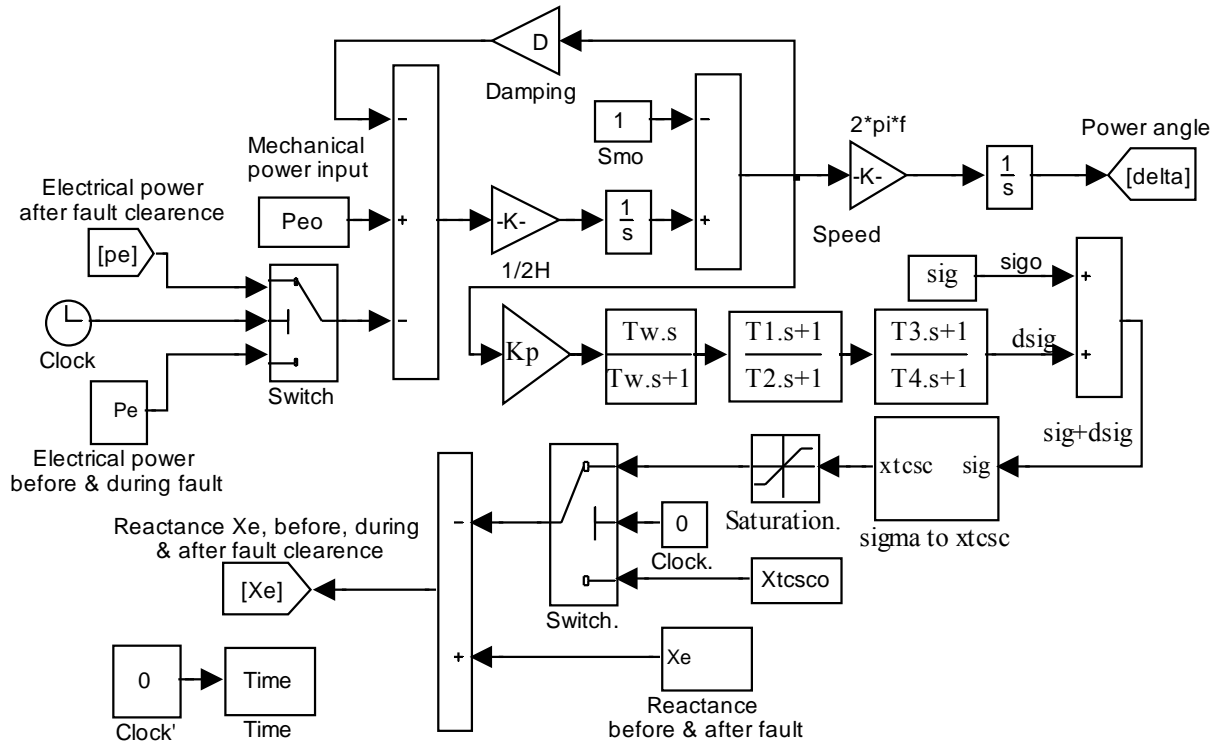

Fig. 5 SIMULINK model of SMIB with TCSC controller

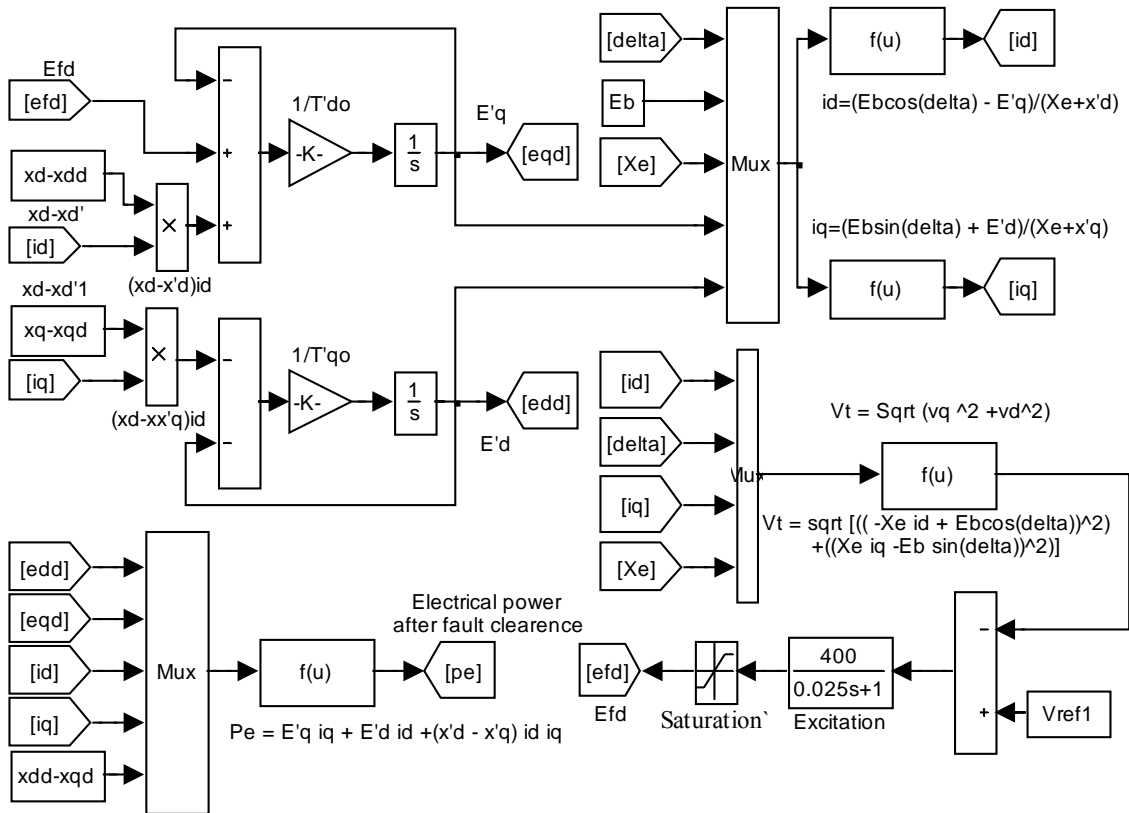

Fig. 6 SIMULINK model for calculation of i_d , i_q , E'_d , E'_q and P_e

The SIMULINK model for calculation of i_d, i_q, E'_d, E'_q and P_e is shown in Fig.6. The relevant parameters are given in appendix.

The objective function is evaluated for each individual by simulating the system dynamic model considering a three-phase fault at the generator terminal busbar at $t = 1.0$ sec. For the purpose of optimisation of equation (14), routines from GA toolbox were used. The fitness function comes from time-domain simulation of power system model shown in Fig. 5. Using each set of controllers' parameters, the time-domain simulation is performed and the fitness value is determined. Good solutions are selected, and by means of the GA operators, new and better solutions are achieved. This procedure continues until a desired termination criterion is achieved. Although the chances of GA giving a local optimal solution are very few, sometimes getting a suboptimal solution is also possible. While applying GA, a number of parameters are required to be specified. An appropriate choice of these parameters affects the speed of convergence of the algorithm. For different problems, it is possible that the same parameters for GA do not give the best solution, and so these can be changed according to the situation.

TABLE I

PARAMETERS USED IN GENETIC ALGORITHM

Parameter	Value/Type
Maximum generations	100
Population size	50
Type of selection	Normal geometric [0 0.08]
Type of crossover	Arithmetic [2]
Type of mutation	Nonuniform [2 100 3]
Termination method	Maximum generation

TABLE II

OPTIMIZED TCSC CONTROLLER PARAMETERS USING GENETIC ALGORITHM

Gain	Time constants			
	T_{IT}	T_{2T}	T_{3T}	T_{4T}
32.6247	0.1464	0.1402	0.1235	0.1524

In Table I the parameters for GA optimization routines are given. The description of these operators and their properties can be found in reference [16]. One more important point that affects the optimal solution more or less is the range for unknowns. For the very first execution of the programme, a wider solution space can be given and after getting the solution one can shorten the solution space nearer to the values obtained in the previous iteration. Optimization is terminated by the prespecified number of generations. The best individual of the final generation is the solution. The optimized parameters are shown in Table II. Fig. 7 shows the convergence rate objective function J with the number of generations.

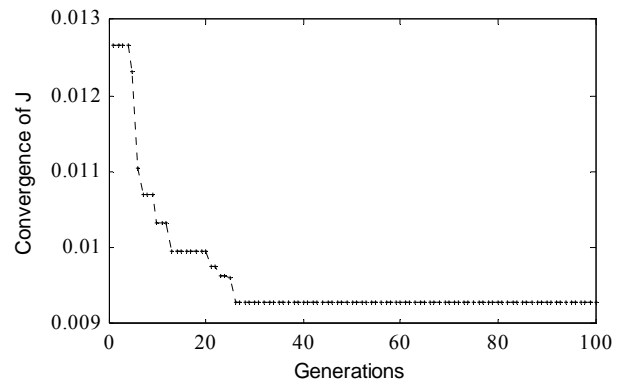

Fig. 7 Convergence rate of objective function J.

B. Simulation Results

In order to show the advantages of modelling the synchronous generator with TCSC controller and tuning its parameters in the way presented in this paper, simulation studies are carried out for the example power system subjected to various severe disturbances as well as small disturbance. The following cases are considered:

Case-1: Three-phase Fault Disturbance

A three phase fault is applied at the generator terminal busbar at $t = 1$ sec and cleared after 5 cycles. The original system is restored upon the fault clearance. To study the performance of TCSC controller, two cases are considered; with and without genetically tuned TCSC controller. The response without the controller (no control) is shown with dotted line with legend NC; and the responses with TCSC controller optimized using GA is shown with solid line with legend GATCSC.

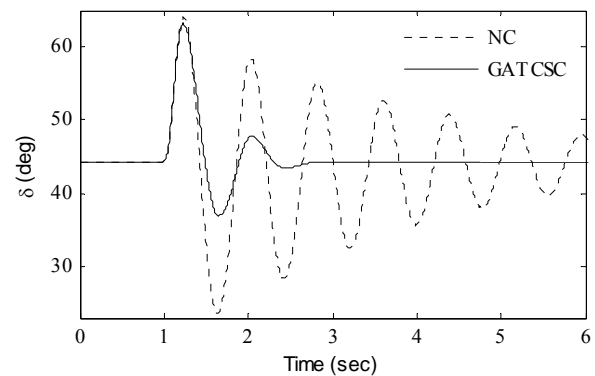

Fig. 8 Variation of power angle δ , without and with TCSC controller for a 5-cycle three-phase fault disturbance (Case-1)

The system power angle response for the above contingency is shown in Fig. 8. It is clear from the Fig. 8 that, without controller even though the system is stable, power system oscillations are poorly damped. It is also clear that, proposed TCSC controller significantly suppresses the oscillations in the power angle and provides good damping characteristics to low frequency oscillations by stabilizing the

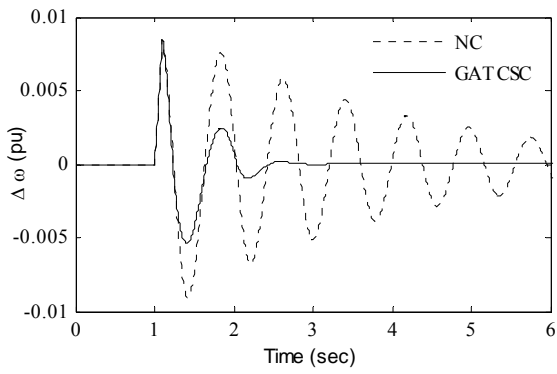

Fig. 9 Variation of speed deviation $\Delta\omega$: Case-1

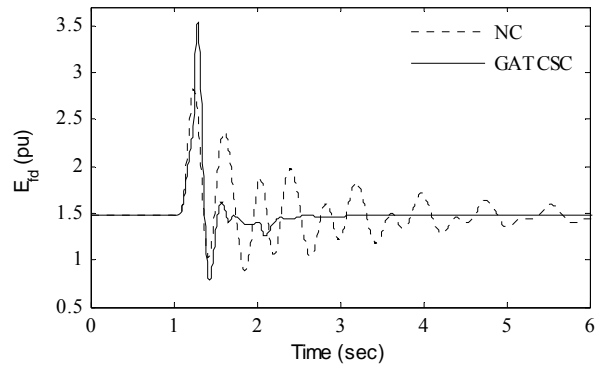

Fig. 13 Variation of voltage E_{fd} : Case-1

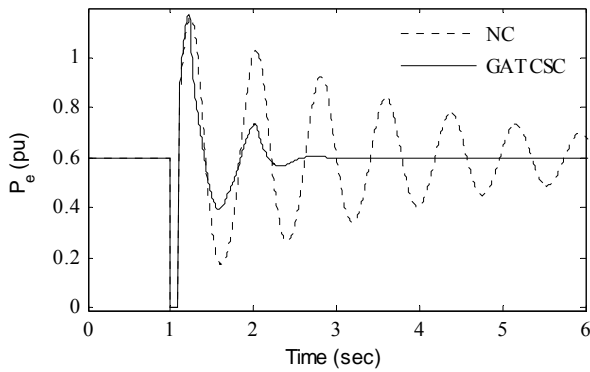

Fig. 10 Variation of electrical power P_e : Case-1

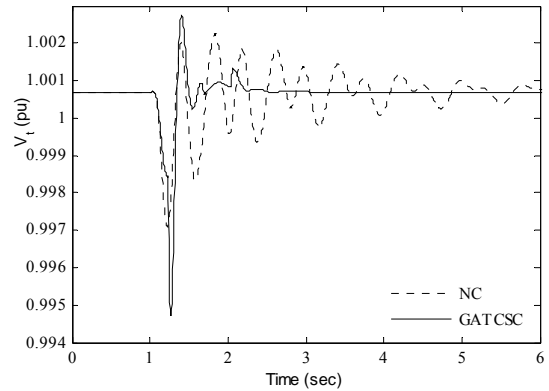

Fig. 14 Variation of terminal voltage V_t : Case-1

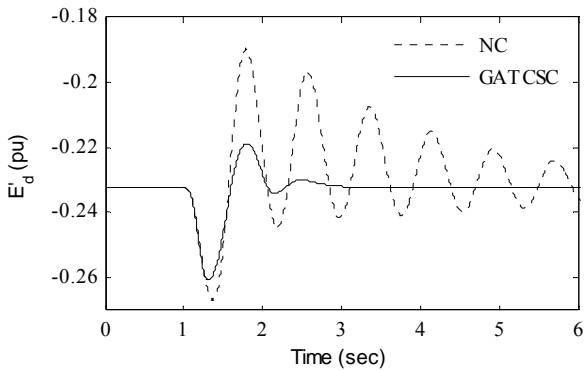

Fig. 11 Variation of voltage E'_d : Case-1

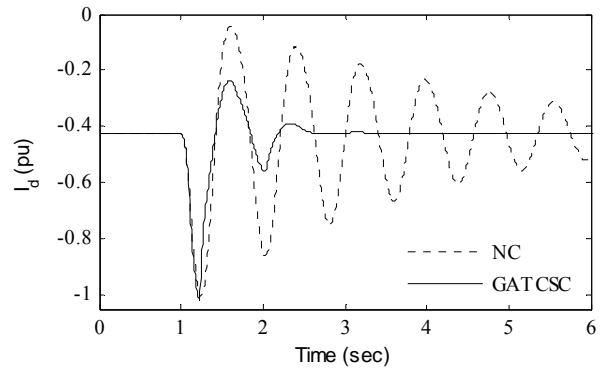

Fig. 15 Variation of current I_d : Case-1

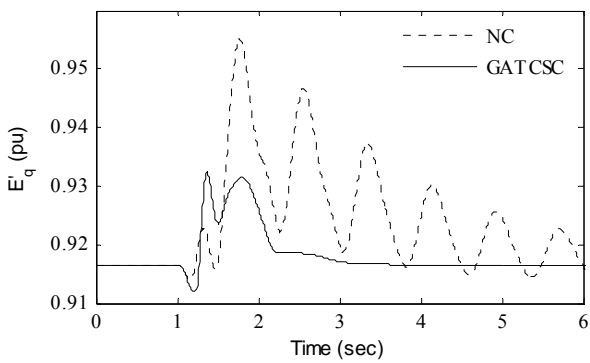

Fig. 12 Variation of voltage E'_q : Case-1

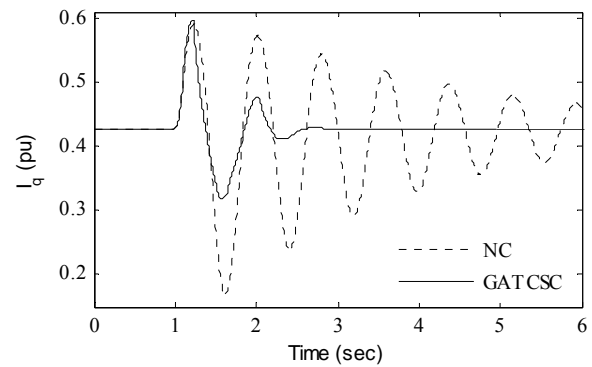

Fig. 16 Variation of current I_q : Case-1

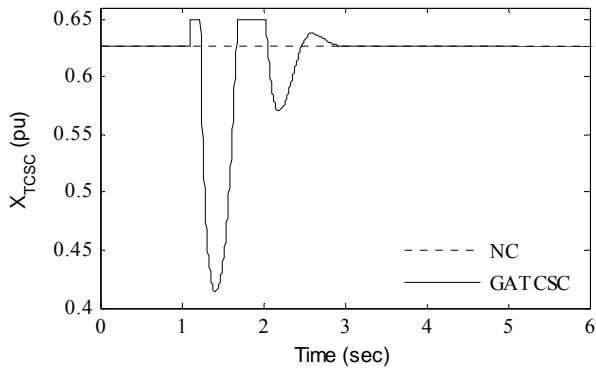

Fig. 17 Variation of X_{TCSC} : Case-1

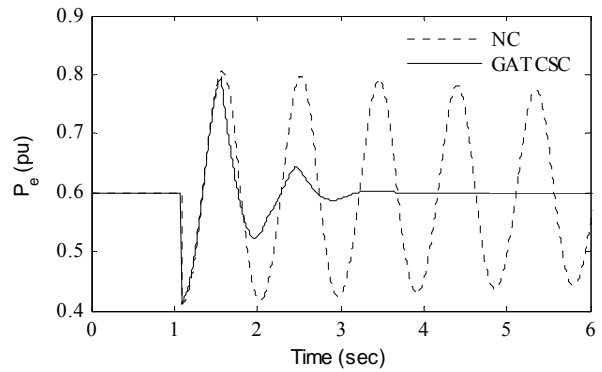

Fig. 20 Variation of electrical power P_e : Case-2

system much faster. Figs. 9 - 17 shows the variation of speed deviation $\Delta\omega$, electrical power P_e , voltages E'_d , E'_q , E_{fd} , V_t , currents i_d , i_q and reactance offered by TCSC: X_{TCSC} , respectively all with respect to time for the above mentioned contingency (Case-1). It is clear from these figures that, the genetically tuned TCSC controller improves the stability performance of the example power system and power system oscillations are well damped out.

Case-2: Line-outage Disturbance

In this case another severe disturbance is considered. One of the transmission line is permanently tripped out at $t = 1$ sec. The system response for the above contingency is shown in Figs. 18-26.

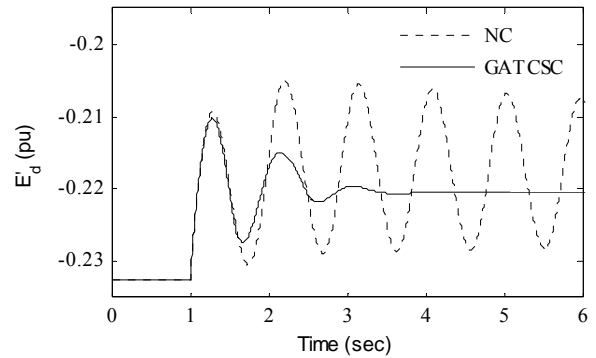

Fig. 21 Variation of voltage E'_d : Case-2

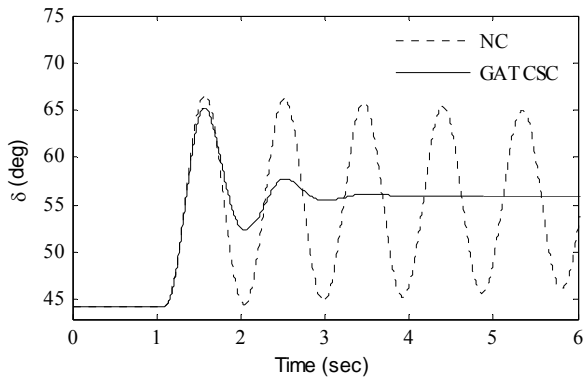

Fig. 18 Variation of power angle δ : Case-2

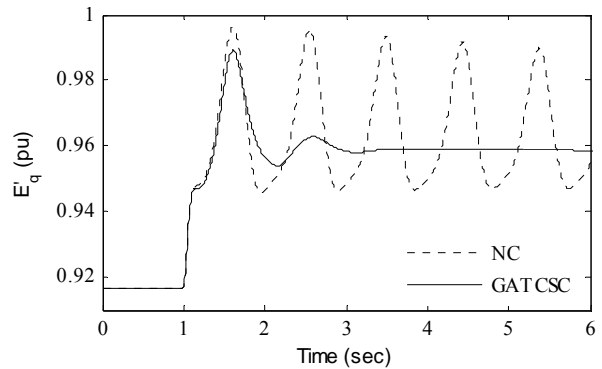

Fig. 22 Variation of voltage E'_q : Case-2

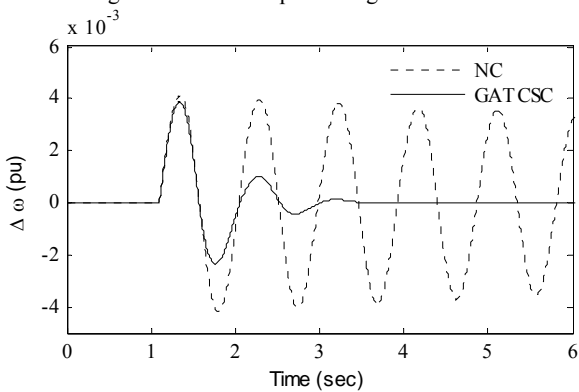

Fig. 19 Variation of speed deviation $\Delta\omega$: Case-2

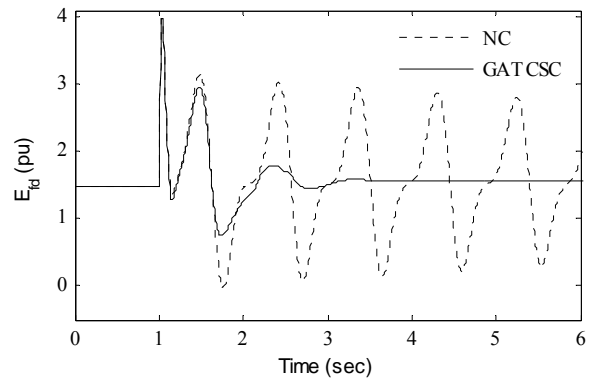

Fig. 23 Variation of voltage E_{fd} : Case-2

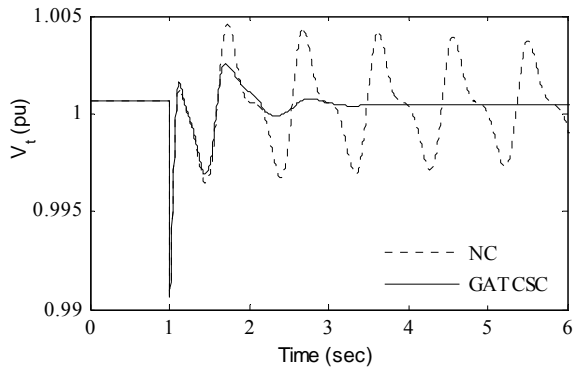

Fig. 24 Variation of terminal voltage V_t : Case-2

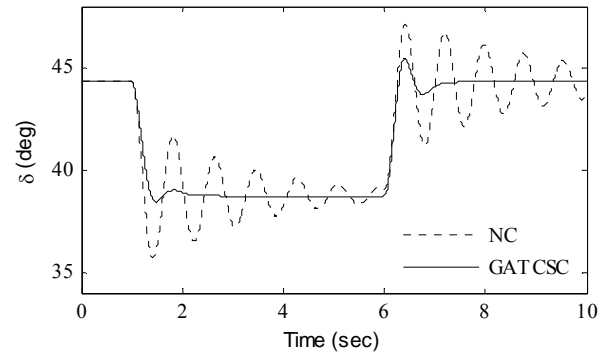

Fig. 27 Variation of power angle δ : Case-3

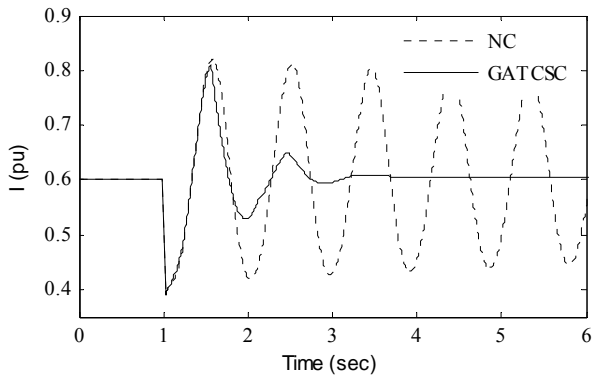

Fig. 25 Variation of line current I : Case-2

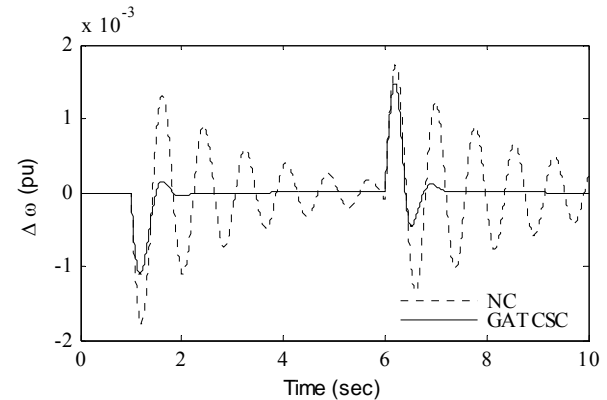

Fig. 28 Variation of speed deviation $\Delta\omega$: Case-3

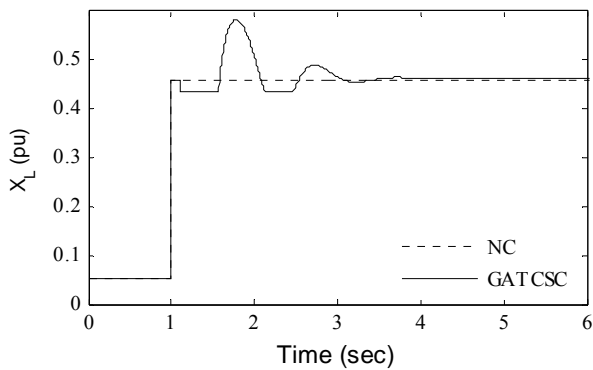

Fig. 26 Variation of transfer reactance X_L : Case-2

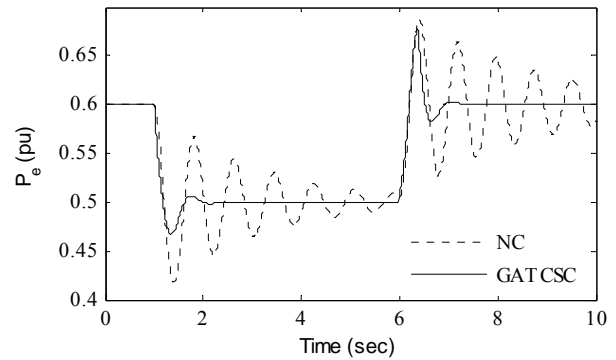

Fig. 29 Variation of electrical power P_e : Case-3

The simulation results show the effectiveness of the proposed modelling and tuning approach. It is also clear from the Figs. that the proposed GA optimized TCSC-based controller has good damping characteristics to low frequency oscillations and quickly stabilizes the system under this severe disturbance.

Case-3: Small Disturbance

In order to verify the effectiveness of the proposed TCSC controller optimized using GA, under small disturbance, the mechanical power input to the generator is decreased by 1 pu at $t = 1$ sec and the disturbance is removed at $t = 6$ sec. The system response under this small disturbance contingency is shown in Figs. 27-31.

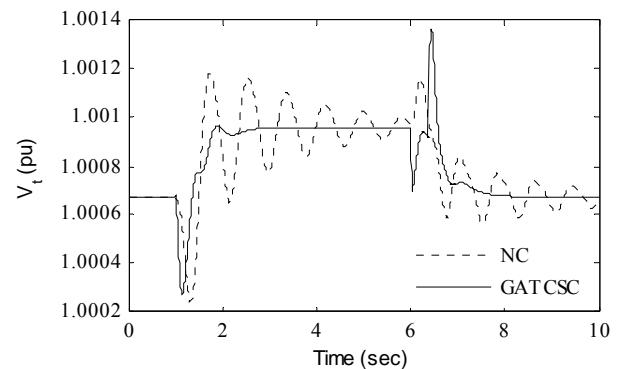

Fig. 30 Variation of terminal voltage V_t : Case-3

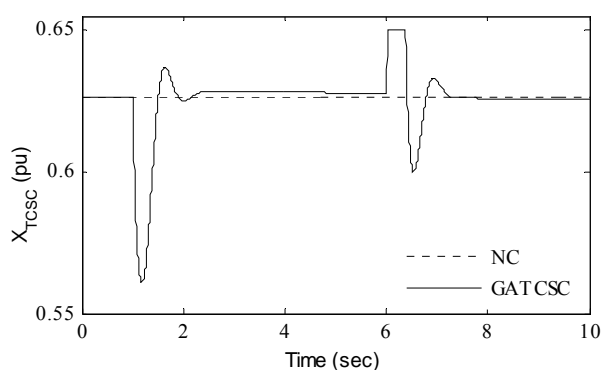

Fig. 31 Variation of X_{TCSC} : Case-3

It is clear from the Figs. 27-31 that, the proposed GA optimized TCSC-based controller has good damping characteristics to low frequency oscillations and quickly stabilizes the system under this small disturbance

VI. CONCLUSION

The MATLAB/SIMULINK model of a single-machine infinite-bus power system with a TCSC controller presented in the paper provides a means for carrying out power system stability analysis and for explaining the generator dynamic behaviour as effected by a TCSC. This model is far more realistic compared to the model available in open literature, since the synchronous generator with field circuit and one equivalent damper on q-axis is considered. Further, for the TCSC controller design problem, a parameter-constrained, time-domain based, objective function, is developed to improve the performance of power system subjected to a disturbance. Then, GA is employed to search for the optimal TCSC controller parameters. The controller is tested on example power system subjected to various large and small disturbances. The simulation results show that, the genetically tuned TCSC controller improves the stability performance of the power system and power system oscillations are effectively damped out. Hence, it is concluded that the proposed model is suitable for carrying out power system stability studies in cases where the dynamic interactions of a synchronous generator and a TCSC are the main concern.

APPENDIX

System data: All data are in pu unless specified otherwise.

Generator: $H = 3.542$, $D = 0$, $X_d = 1.7572$, $X_q = 1.5845$,
 $X'_d = 0.4245$, $X'_q = 1.04$, $T'_{do} = 6.66$, $T'_{qo} = 0.44$, $R_a = 0$, $P_c = 0.6$,
 $Q_c = 0.02224$, $\delta_0 = 44.37^\circ$.
Exciter: $K_A = 400$, $T_A = 0.025$ s
Transmission line: $R = 0$, $X_L = 0.8125$, $X_T = 0.1364$,
 $X_{TH} = 0.13636$, $G = 0$, $B = 0$;
TCSC Controller: $T_{TCSC} = 15$ ms, $\alpha_0 = 142^\circ$, $X_{TCSC0} = 0.62629$,
 $k = 2$, $T_W = 10$ s, $X_{MAX} = 0.8 X_L$, $X_{MIN} = 0$.

REFERENCES

- [1] W.G. Heffron and R.A. Phillips, 'Effect of modern amplidyne voltage regulator characteristics', *IEEE Transactions*, PAS-71, pp. 692-697, 1952.
- [2] F.P. Demello and C. Concordia, "Concepts of synchronous machine stability as affected by excitation control", *IEEE Transactions*, PAS-88, (4), pp. 189-202, 1969.
- [3] N. G. Hingorani and L. Gyugyi, *Understanding FACTS: Concepts and Technology of Flexible AC Transmission System*. IEEE Press, 2000.
- [4] H.F.Wang and F.J.Swift, "A unified model for the analysis of FACTS devices in damping power system oscillations part I: single-machine infinite-bus power systems," *IEEE Trans. Power Delivery*, Vol. 12, No. 2, pp. 941-946, 1997.
- [5] H.F.Wang "Phillips-Heffron model of power systems installed with STATCOM and applications" *IEE Proc-Gener. Transm. Distrib.*, Vol. 146, No. 5, pp. 521-527, 1999.
- [6] H.F.Wang "A Unified Model for the Analysis of FACTS Devices in Damping Power System Oscillations—Part III: Unified Power Flow Controller", *IEEE Transactions on Power Delivery*, Vol. 15, No. 3, pp. 978-983, 2000.
- [7] S. Panda, N.P.Padhy and R.N.Patel, "Modelling, simulation and optimal tuning of TCSC controller", *International Journal of Simulation Modelling*, Vol. 6, No. 1, pp. 37-48, 2007.
- [8] Available: <http://www.control-innovation.com/>
- [9] Y.L. Abdel-Magid and M.A. Abido, "Coordinated design of a PSS and a SVC-based controller to enhance power system stability", *Electrical Power & Energy Syst*, Vol. 25, pp. 695-704, 2003.
- [10] S. Panda, N.P.Padhy "Thyristor Controlled Series Compensator-based Controller Design Employing Genetic Algorithm: A Comparative Study", *International Journal of Electronics Circuits and Systems*, Vol. 1, No. 1, pp. 38-47, 2007.
- [11] Y.L. Abdel-Magid and M.A.Abido, "Robust coordinated design of excitation and TCSC-based stabilizers using genetic algorithms", *International Journal of Electrical Power & Energy Systems*, Vol. 69, No. 2-3, pp. 129-141, 2004.
- [12] D. E. Goldberg, *Genetic Algorithms in Search, Optimization and Machine Learning*. Addison-Wesley, 1989.
- [13] K. R. Padiyar, *Power System Dynamics Stability and Control*, BS Publications, 2nd Edition, Hyderabad, India, 2002.
- [14] P. Kundur, *Power System Stability and Control*. New York: McGraw-Hill, 1994.
- [15] R. M Mathur and R. K. Verma, *Thyristor-based FACTS Controllers for Electrical Transmission Systems*, IEEE press, Piscataway, 2002.
- [16] C. Houck, J. Joines and M. Kay, A genetic algorithm for function optimization: A MTLAM implementation. NCSU-IE, TR 95-09. 1995. Available: <http://www.ise.ncsu.edu/mirage/GAToolBox/gaot>

Sidhartha Panda received the M.E. degree in Power Systems Engineering from University College of Engineering, Burla, Sambalpur University, India in 2001. Currently, he is a Research Scholar in Electrical Engineering Department of Indian Institute of Technology Roorkee, India. He was an Associate Professor in the Department of Electrical and Electronics Engineering, VITAM College of Engineering, Andhra Pradesh, India and Lecturer in the Department of Electrical Engineering, SMIT, Orissa, India. His areas of research include power system transient stability, power system dynamic stability, FACTS, optimization techniques, distributed generation and wind energy.

Narayana Prasad Padhy was born in India and received his Degree (Electrical Engineering), Masters Degree (Power Systems Engineering) with Distinction and Ph.D., Degree (Power Systems Engineering) in the year 1990, 1993 and 1997 respectively in India. Then he has joined the Department of Electrical Engineering, Indian Institute of Technology (IIT) India, as a Lecturer, Assistant Professor and Associate Professor during 1998, 2001 and 2006 respectively. Presently he is working as a Associate Professor in the Department of Electrical Engineering, Indian Institute of Technology (IIT) India. He has visited the Department of Electronics and Electrical Engineering, University of Bath, UK under Boyscast Fellowship during 2005-06. His area of research interest is mainly Power System Privatization, Restructuring and Deregulation, Transmission and Distribution network charging, Artificial Intelligence Applications to Power System and FACTS.