

WLAN Positioning Based on Joint TOA and RSS Characteristics

Peerapong Uthansakul and Monthippa Uthansakul

Abstract—WLAN Positioning has been presented by many approaches in literatures using the characteristics of Received Signal Strength (RSS), Time of Arrival (TOA) or Time Difference of Arrival (TDOA), Angle of Arrival (AOA) and cell ID. Among these, RSS approach is the simplest method to implement because there is no need of modification on both access points and client devices whereas its accuracy is terrible due to physical environments. For TOA or TDOA approach, the accuracy is quite acceptable but most researches have to modify either software or hardware on existing WLAN infrastructure. The scales of modifications are made on only access card up to the changes in protocol of WLAN. Hence, it is an unattractive approach to use TOA or TDOA for positioning system. In this paper, the new concept of merging both RSS and TOA positioning techniques is proposed. In addition, the method to achieve TOA characteristic for positioning WLAN user without any extra modification necessarily appended in the existing system is presented. The measurement results confirm that the proposed technique using both RSS and TOA characteristics provides better accuracy than using only either RSS or TOA approach.

Keywords—Received signal strength, Time of arrival, Positioning system, WLAN, Measurement.

I. INTRODUCTION

RECENTLY, the launch of the Global Positioning System (GPS) [1], positioning systems have been used to deliver Location-Based Services (LBS) [2], [3] in outdoor environments. The primary role of such positioning systems is to estimate and report geographical information pertaining to their users for the purposes of management, enhancement, and personalization of services. Unfortunately, the level of localization accuracy needed for indoor applications cannot be achieved by the existing GPS methods. Furthermore, coverage of the GPS system in an indoor environment and dense urban area is limited [4], [5]. In this light, a plethora of indoor positioning systems has been proposed employing various technologies [5], [6] such as proximity sensors, infrared [7], radio frequency and ultrasonic badges [8], [9], Wireless Local Area Network (WLAN) radio signals [10], [11], and visual sensors [12]. Among those techniques, visual surveillance and tracking is the most widely studied and has been shown to provide highly accurate estimations [12]. However, this type

The authors are with the School of Telecommunication Engineering, Suranaree University of Technology, Nakhon Ratchasima, Thailand 30000 (corresponding author phone: 66-44-224351; fax: 66-44-224603; e-mail: uthansakul@sut.ac.th).

This work is financially supported by Suranaree University of Technology.

of positioning techniques requires installation of infrastructure and calibration of cameras, which can lead to hardware and labor overheads in pervasive deployments. An even more profound concern is that of privacy in situations where users choose not to be visually monitored. With these concerns, several works have considered positioning based on WLANs owing to their wide availability and ubiquitous coverage in large environments.

From literatures, the positioning methods based on WLAN infrastructure can be classified into four methods depending on characteristics utilized to estimate the location. These characteristics are Time of Arrival (TOA) or Time Difference of Arrival (TDOA), Angle of Arrival (AOA), Received Signal Strength (RSS) and cell-ID. The TOA is another parameter to indicate the location by measuring the propagation delays. It needs an accurate synchronization between access point and user. The TDOA method is developed from TOA to make ease of accurate synchronizations by capturing time interval of data transmission instead of propagation delays. For this method, the measurement error is inversely proportional to the bandwidth and independent on the distance between access point and user. Utilizing AOA, the measurement error is proportional to the product of the angular error and the distance between access point and user. The RSSI is a method to measure the distance between access points and user using the received signal strength. The Cell-ID is considered to be the simplest method to determine the position of user. In this method, the access point position with the strongest signal at user is assumed to be the position of user. Among those four parameters, TDOA or TOA are the best for indoor positioning systems. This is because the accuracy of positioning is not affected by multipath and distance between access point and user. In [13], the system employing TDOA is composed of special receiver, tags, and location server. The special receivers receive the positioning signal sent by a tag and then the received timing is sent to the server for calculating the tag's position. The drawback of this system is that the special tags must be used resulting in complexity. The same approach is also used in [14] but only minor changes have been made focusing on hardware. In [15], only two access points used for evaluating TOA are proposed instead of three access points. The tracking feature such a Kalman-based filter is necessary to be included in both access points. The approach using both TOA and TDOA is proposed in [16]. The experimental results confirm the superior performance of the methods using time delays over RSS method. In this paper, the concept of merging

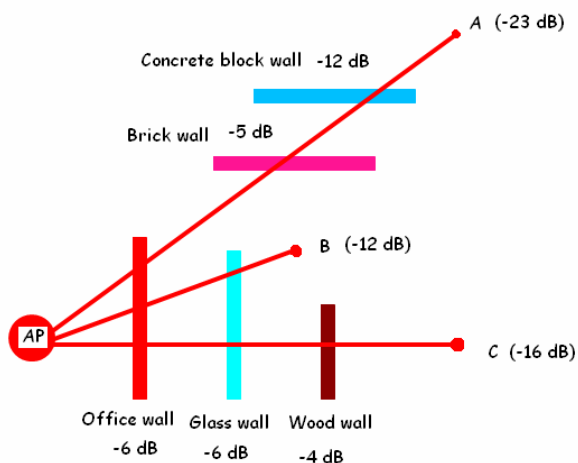

Fig.1 Attenuation factor for each type of obstruction

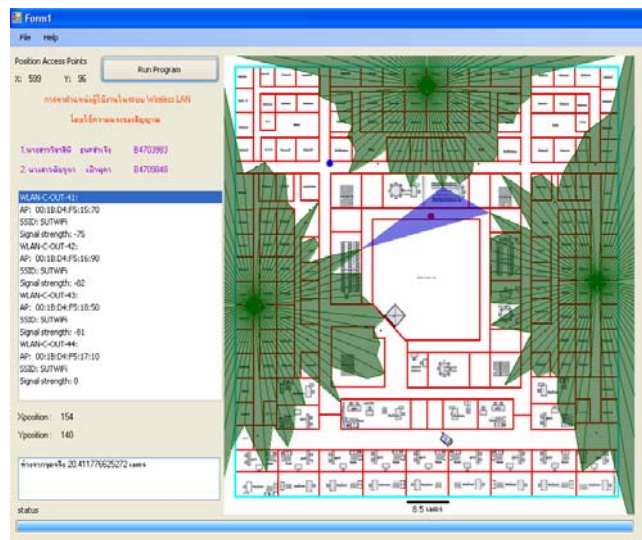

Fig.2 Example of positioning based RSS characteristic

Open Science Index, Electronics and Communication Engineering Vol:3, No:4, 2009 publications.waset.org/5152.pdf

both approaches using RSS and TOA characteristics is proposed in order to combine both advantages for increasing the position accuracy.

Although the methods using TDOA or TOA for positioning system are widely successful in literatures, they still gain less attraction than the system using RSSI. This is due to the fact that RSSI measurements can be obtained relatively effortlessly and inexpensively without the need for additional hardware [17], unlike the system utilizing TDOA or TOA. Therefore, also in this paper, the TOA approach is developed to estimate the user location utilizing the measured time delays without any extra modifications of either firmware or hardware on existing infrastructure. In additional, the proposed method has been verified by the measurement data of time delays of successful transmissions.

In particular, the contributions of this paper are i) the concept of combining both RSS and TOA characteristics for positioning WLAN user ii) the TOA approach presented in this paper does not require the modification on existing WLAN equipments so it is easy to implement on everywhere and iii) its performances of using proposed technique through measurement results in comparing with only RSS and TOA approach is presented. The remainder of paper is organized as follows. In the following section, the positioning technique based RSS and TOA characteristics have been described in Section II and III, respectively. In Section IV, the proposed technique to combine both approaches is detailed. The experiments and discussions are given in Section V. Finally, this work is concluded in Section VI.

II. POSITIONING BASED RECEIVED SIGNAL STRENGTH

This paper aims to find the position of WLAN users on any configurations of operating area. Therefore, the use of *fingerprint* approach is not applicable to our purpose. Nevertheless, the positioning based pre-measured data or so-

called *fingerprint* is still noted as the technique to provide the best accuracy for type of RSS characteristic. In this paper, the position of user is calculated by translating RSS into distances from surrounding access points without prior knowledge of *fingerprint* technique.

A. Propagation Modeling

This paper adopts the indoor propagation modeling presented in [18] which can be rewritten here as

$$RSS = Pt - 20 \log \frac{\lambda}{4\pi d} - \sum_i \alpha_i \quad (1)$$

Where RSS is the received signal strength in dB, Pt is the transmitted signal power at access point in dB, λ is the wavelength of operating WLAN system, d is the distance between access point and user and α_i is the attenuation factor of i th component in the route between access point and user.

Fig. 1 depicts the attenuation factor for each type of obstruction. For example, the obstructions between access point and user A has three components which are office wall, brick wall and concrete block wall. In this case, the total attenuation due to three components is -23 dB.

B. RSS Measurements

The measurement is performed on the fourth floor of C-Building, Suranaree University of Technology. There are four access point covering WLAN services on this floor. The authors develop Visual C++ programming to capture RSS from each access point and then calculating the possible distances away from each access point. Fig. 2 shows the example of Visual C++ screenshot. As seen in Fig. 2, there are three green regions which are computed by using measured RSS and (1).

C. Positioning technique

For RSS approach in this paper, the user position is

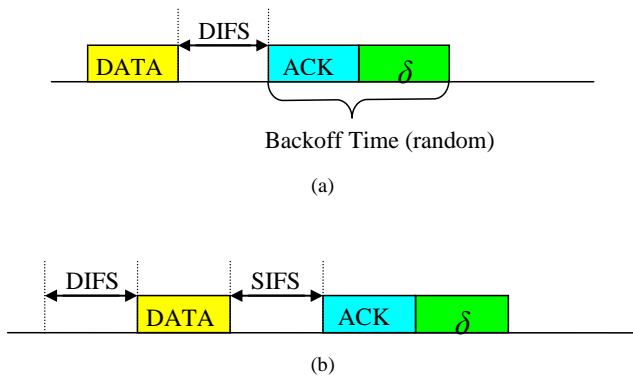

Fig. 3. WLAN basic access mechanism (a) ACK message is sent after its data frame (b) ACK message is sent after other data frame.

achieved by using two steps. Firstly, the smallest triangle connecting three green regions shown in Fig. 2 has to be computed. As seen in Fig. 2, the blue triangle is a solution for this example. In order to get this triangle, the exhaustive method is implemented.

The second step aims to find the best approximated location of user. This paper chooses the center of smallest triangle to be the user position. Note that the center is defined as the position reaching all tips with the same distance.

III. POSITIONING BASED TIME OF ARRIVAL

For TOA approach, this paper utilizes a principle of time delay distribution based measured results to find the user position. This approach does not require any modification neither access point nor client. Therefore, the following subsections will ground basic understanding on time delay distribution and its measurement. Then the positioning technique is detailed later.

A. WLAN distributed coordinating function

The IEEE 802.11 standard for wireless networks incorporates two medium access methods, the mandatory Distributed Coordination Function (DCF) method and the optional Point Coordination Function (PCF). The DCF is an asynchronous data transmission function, which well suits delay insensitive data such as email and ftp. It is available in ad-hoc or infrastructure network configurations and can be either used exclusively or combined with PCF in an infrastructure network. The PCF, on the other hand, well suits delay sensitive data transmissions such as real-time audio or video and is only available in infrastructure environments.

The Basic Service Set (BSS) is the basic building block of IEEE 802.11 WLANs. The coverage area of a BSS is referred as Basic Service Area (BSA). A station being a member of the BSS within the BSA may continue communicating with other members of the BSS. The IEEE 802.11 defines two types of network architecture, the ad-hoc network and the infrastructure network. An ad-hoc network deliberates on the grouping of stations into a BSS without the need for any

TABLE I
 EXAMPLE OF BACKOFF COUNTERS FOR $CW_{min}=32$, $m=5$, $R=6$.

Transmission Attempt	Backoff stage	CW Range
First Transmission Attempt	0	0 - 31
First Retransmission	1	0 - 63
Second Retransmission	2	0 - 127
Third Retransmission	3	0 - 255
Fourth Retransmission	4	0 - 511
Fifth Retransmission	5	0 - 1023
Sixth Retransmission	6	0 - 1023

infrastructure implementation. This type of IEEE 802.11 WLAN is often formed for only as long as the WLAN is needed. The infrastructure networks, in contrast to the ad-hoc networks, create a range extension and obtain some specific services from other wired or wireless LANs via infrastructure implementations.

The DCF is based on the Carrier Sense Multiple Access with Collision Avoidance (CSMA/CA) protocol. Under DCF, data frames are transferred via two methods. The essential method used in DCF is called basic access method. The 802.11 standard also provides an alternative way of transmitting data frames, namely the RTS/CTS method. In this paper, the authors focus only on basic access method.

Priority access to the wireless medium is controlled by the use of the Inter Frame Space (IFS) time period between the transmissions of frames. The IFS defines the minimal time that a station has to let pass after the end of a frame, before it may start transmitting a certain type of frame. In 802.11, three different IFS intervals have been specified to provide various priority levels for access to the wireless medium: Short IFS (SIFS), Point Coordination Function IFS (PIFS) and DCF-IFS (DIFS). The SIFS is the smallest followed by PIFS and DIFS. After SIFS interval, only acknowledgements, CTS and data frames may be sent. The use of the PIFS and the DIFS is used to separate the PCF and DCF modes, giving a higher priority to the former.

In order to minimize the probability of collisions, a random backoff mechanism is used to randomize moments at which stations are trying to access the wireless medium. The demonstration of backoff mechanism is shown in Fig. 3. This contention resolution technique is called Binary Exponential Backoff (BEB). In particular, the time following an idle DIFS is slotted and a station is allowed to transmit only at the beginning of each slot. A slot time is equal to the time needed by any station to detect the transmission of a frame from any other station. The backoff counter is decremented when the medium is idle and is frozen when the medium is sensed busy. After a busy period the backoff resumes only after the medium has been idle longer than DIFS. A station initiates a frame transmission when the backoff counter reaches zero.

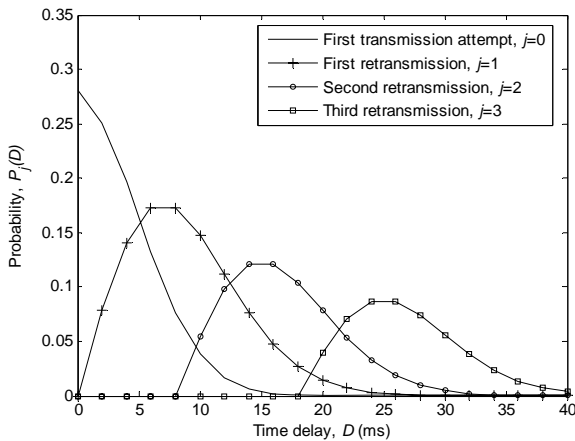

Fig. 4. Probability of a successful transmission for parameters in Table II

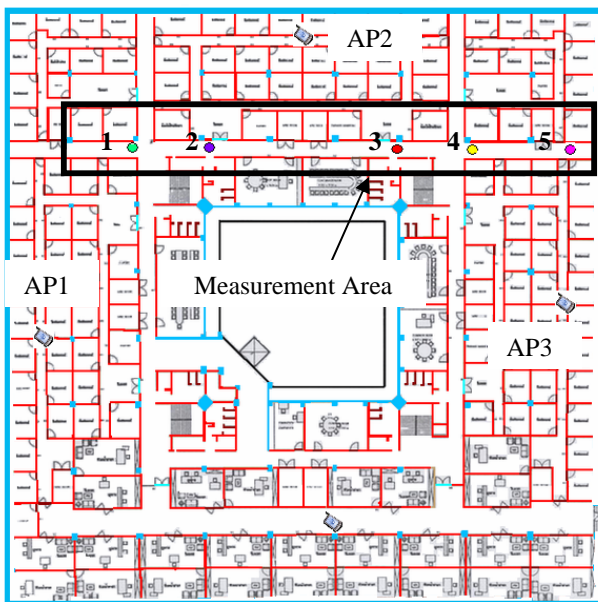

Fig. 5. Map of measurement area

The Contention Window (CW) is chosen in the interval $(0, CW-1)$. The value of CW depends on the number of failed transmissions of a frame. At the first transmission attempt, CW is set equal to CW_{min} , which is called minimum contention window. A collision occurs when two or more stations start transmission simultaneously in the same slot. After each retransmission due a collision, CW is doubled up to a maximum value, $CW_{max} = 2^m CW_{min}$ where m is the number of different contention window sizes. Once the CW reaches CW_{max} , it will remain at the value of CW_{max} until it is reset.

The CW is reset to CW_{min} in the following cases: (a) after every successful transmission of a data frame (b) when number of retry reaches the Short Retry Limit, R, and (c)

TABLE II
 PARAMETERS USED FOR SIMULATING FIGURE 2.

Frame interval, T_{frame}	8.6 μs
DIFS	50 μs
SIFS	10 μs
Propagation Delay, δ	1 μs
ACK interval, T_{ACK}	0.3 μs
σ	20 μs
CW_{min}	32
m	5
R	6
Number of users	20

when number of retry reaches the Long Retry Limit. When either of these limits is reached, retry attempts shall cease and the frame shall be discarded. The example of CW range is shown in Table I for $CW_{min}=32$, $m=5$, $R=6$.

After a successful frame transmission, if the station still has frames buffered for transmission, it must execute a new backoff process. The set of CW values are sequentially ascending integer powers of 2 minus 1 as presented in Table I.

After receiving correctly a frame in the destination station, an immediate positive acknowledgement (ACK) is sent to confirm the successful reception of the frame transmission after a time interval equal to SIFS. Since the SIFS interval is shorter than the DIFS interval, the station sending an ACK attempts transmission before stations attempting to send data and hence take priority. If the source station does not receive an ACK, the data frame is assumed to have been lost and a retransmission is scheduled.

B. Time Delay Distribution

In this paper, time delay of successful transmission is defined as the time interval from the moment that data frame is queued in MAC layer until the ACK message for this frame is received. Following the formulas in [19], the probability P that a frame is successfully transmitted after a given time delay D is the summation of the probabilities for the time delay D at all backoff stage.

$$P(D) = \sum_{j=0}^R P_j(D) \quad \text{for } 0 \leq D \leq \infty \quad (2)$$

Where j is the stage number of backoff and $P_j(D)$ is the probability of successful transmission at j th backoff stage with time delay D . The time delay D of a successful transmission is computed as

$$D = T_c N_j + N_e \sigma + j T_c + T_s \quad (3)$$

Where N_e is the number of empty slots that a frame encounters before its successful transmission, σ is the duration of an empty slot, N_j is the number of transmissions from the

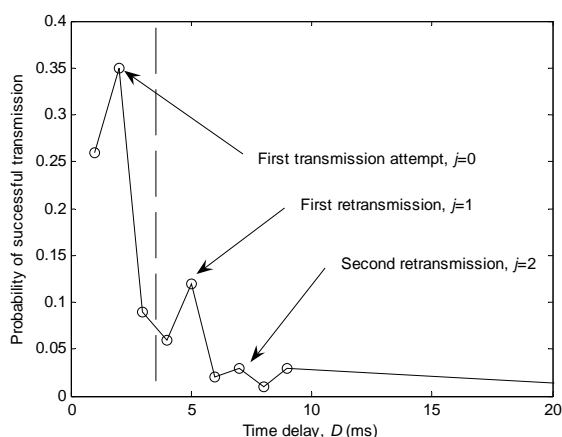

Fig. 6. Example of probability calculated by measured time delays

rest of the stations that a frame encounters before its successful transmission, T_s and T_c is the time duration of channel that is sensed busy during a successful transmission and a collision, respectively.

The time duration of T_s and T_c depend on the channel access methods. For basic access method, the interval of T_s and T_c can be expressed as

$$T_s \approx T_c = DIFS + T_{frame} + SIFS + T_{ACK} + 2\delta \quad (4)$$

Where T_{frame} and T_{ACK} is the time interval of frame and ACK messages, respectively, δ is the propagation delay between the user station and access point.

Fig. 4 shows the probability of successful transmission in each backoff stage, $P_j(D)$. All parameters used for simulation is presented in Table II. It can be observed that the total probability of successful transmission, P , consists of multiple peaks due to the chance of successful transmission in each backoff stage. These simulations are based on the constant interval of T_s and T_c given in (4). In fact, the propagation delay, δ , is changed upon the location of users. Consequently, the interval of T_s and T_c is the function of user location and not deterministic. If the user is located in the nearer distance from access point, the interval of T_s and T_c has to be shorter. It implies that the propagation delay, δ , is now considered as TOA which is related to the positioning approach using TOA or TDOA in [13-16].

With the constraint of existing WLAN infrastructures, it is impossible to achieve TOA as same as δ without modifications of hardware and firmware [13-16]. However, as seen in (4), the information of δ can be indirectly realized via the time delay of a successful transmission T_s . In the light of this matter, the distance of user can be realized by T_s instead. Therefore, the new technique for positioning system is proposed by using the time delay of successful transmission.

Although there is a definite relationship between T_s and distance of user station and access point, it is still difficult to

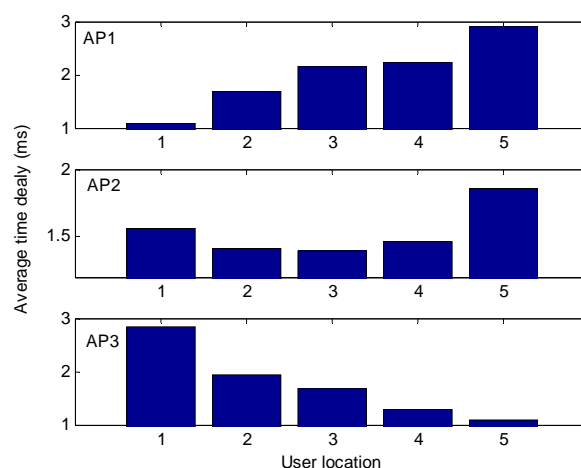

Fig. 7. The average delay time versus user location

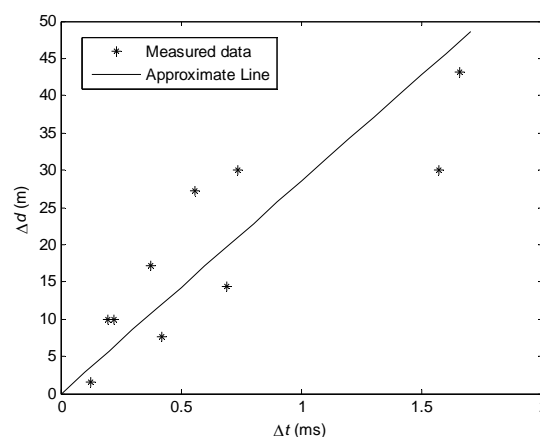

Fig. 8. The relation between time delays and distances

mathematically formulate the function of T_s and distance. In this paper, the empirical concept using measured time delays is adopted here to solve the problem and lead to the positioning method at the end.

C. Time Delay Measurement

The measurement is performed on the fourth floor of C-Building, Suranaree University of Technology. There are four access point covering WLAN services on this floor where the map of measurement area is shown in Fig. 5. The measured locations are marked by number 1 to 5 as presented in Fig. 5.

The method to collect the time delay of successful transmission is to use the ping command from any WLAN receiver such as notebook, PDA, or mobile station. At each location, 100 trial time delays are collected in order to compute the probability of time delays. It is clearly noticed that there is no modification needed at both access point and user hardware. As a result, it can be directly implemented to any existing WLAN system without extra costs.

After collecting all 100 values of time delays, one can calculate the probability of successful transmission as a

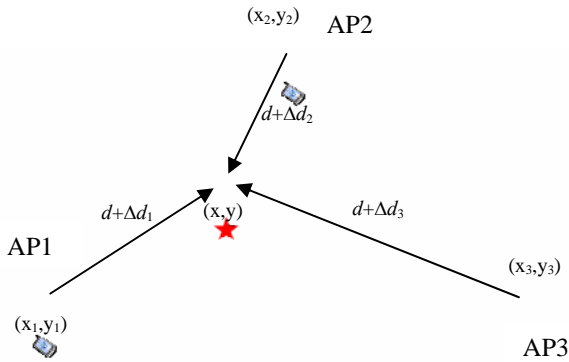

Fig. 9. The configuration of triangle locating

function of time delay. For example, the probability of successful transmission between location 5 and AP2 is shown in Fig. 6. It can be observed that the probability is consisted of multiple peaks as explained by the same reasons as Fig. 4. The delays during the first peak are correspondent to the waiting interval of successful transmission occurred during the first transmission attempt (the range of backoff time is 0 to 31). The next peaks are related to a successful transmission occurred during the next retransmissions.

As mentioned at the end of previous section, the distance between user and access point is directly realized by the time delay of successful transmission. Hence, the aim of illustrating the probability is to find the mean value of time delay. As noticed in Fig. 4 and Fig. 6, the probability is consisted of multiple peaks due to many stages of backoff times. However, each stage provides only one peak. Therefore, by considering only the first peak, it is enough to achieve the average time delay which has the direct relationship to the propagation delay, δ , as same as TOA. Although this average value represents the delay in case of successful transmission occurred only in the first transmission attempt. But it contains the sufficient information of propagation delay that can lead to the user location.

The average time delays calculated from measured data are presented in Fig. 7. Considering AP1, it can be observed that the average time delays increase in order from location 1 to location 5. In turn, the average time delays decrease in order from location 1 to location 5 while considering AP3. For AP2, the average time delays decrease from location 1 to location 3 and then increase from location 3 to location 5. By matching the results with measurement area in Fig. 5, it can be concluded that the average time delay is the function of location. The results provide the good fit with the concept of positioning system which is explained in the next section.

The results in Fig. 7 enlighten the feasibility of positioning a user location by average time delay. In order to fulfill this aim, two tasks have to be carried out. The first task is to find the relation that can convert the average time delay into the

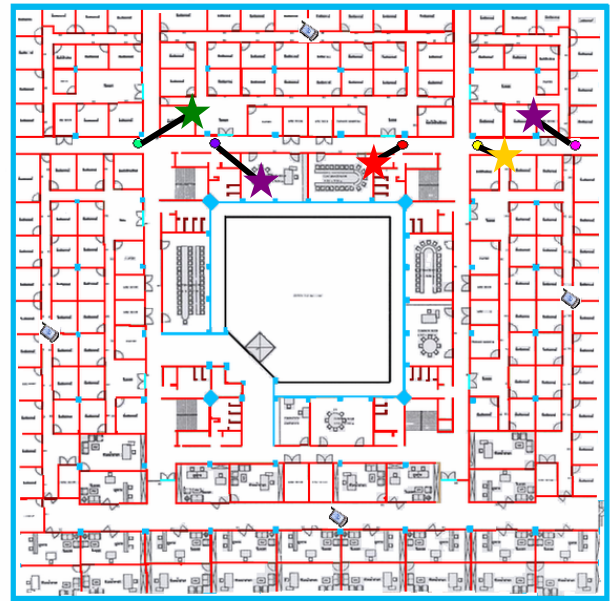

Fig. 10. The estimated locations by only TOA approach

distance. Then the second is to estimate the user position by triangle locating.

D. Distance Approximation

As seen in Fig. 7, the average time delays of each location do not have the direct relation to each other. Hence, the approximate relation has to be applied. In this paper, the time difference, Δt , from minimum delay in each location has been used because it can indirectly calibrate the other factors in each location. For the information of distance, the authors directly measure from the map shown in Fig. 5. The distance difference, Δd , from minimum distance between user and access point is utilized as the same reason as time difference. Fig. 8 shows time difference versus distance difference calculated from all measurement data.

As seen in Fig. 8, the nearer distances are measured, the shorter delays are obtained. However, the measured results are scattered with unpredicted trend. In this paper, the simple linear approximation is employed. The best fit for measured data is illustrated in the solid line shown in Fig. 8. The formula presenting the relation between time delay and distance is approximated as

$$\Delta d = 28.57 \Delta t \quad (5)$$

Where Δd and Δt are in the unit of meter (m) and millisecond (ms), respectively.

E. Positioning Technique

After obtaining the relation between time delay and distance in (5), the next task is to estimate the user location. The concept of triangle locating is adopted to formulate the estimating problem. Fig 9 shows the concept of triangle

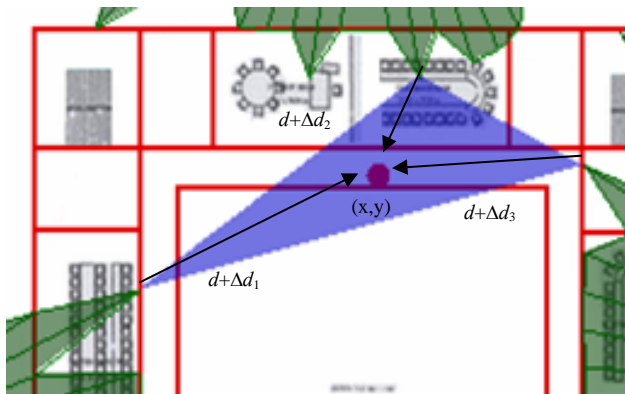

Fig. 11. Triangle locating of joint RSS and TOA

locating which estimates the user location by using the information from three access points. In Fig. 9, it is obvious that there are only three unknown parameters, d , x and y . Using three equations describing distance between user and three access points, all unknown parameters can be estimated.

F. Results and discussions

The estimated locations (x,y) at each measured points are presented as shown with start symbol in Fig. 10. It is clearly seen that the estimated locations are close to the measured locations. The distance errors of location 1 to location 5 are 3.3, 5.7, 1.6, 2.8 and 6.4, respectively. The average error is 3.96 meter which is in the range of one office room only. The results confirm the success of proposed positioning technique on the existing WLAN infrastructure.

IV. POSITIONING BASED JOINT RSS AND TOA

For joint RSS and TOA characteristics, all the procedures detailed in Section II and III are repeated but except for the last step of positioning technique. To combine both features, this paper modifies the positioning technique by applying triangle locating of TOA approach into smallest triangle of RSS approach. Fig. 11 shows the triangle locating of joint RSS and TOA. For joint positioning technique, the first step is to find the smallest triangle depicted as blue triangle in Fig. 11. This blue triangle is achieved by using RSS characteristic. The next step is to implement a triangle locating realized by TOA characteristic. In stead of three coordinates of access points, the tip coordinates are used to find the user position.

V. EXPERIMENTS AND RESULTS

As mentioned in Section III D, the approximated relation between distance and time delay of arrival is created by using measured data. Therefore the area of these measured data used for estimating (5) is called as training area. The experiments are divided into two groups. The first group is performed inside training area and the second group is undertaken outside training area. The purpose of two groups is to verify whether the proposed technique can be effectively used on other physical environments.

In each group, 20 positions are measured and 5 times are

TABLE III
 COMPARISONS BETWEEN VARIOUS POSITIONING TECHNIQUES

Type of Positioning Technique	Inside Training Area		Outside Training Area	
	Error < 3m	Error <10m	Error < 3m	Error <10m
RSS	56 %	78 %	43 %	61 %
TOA	67 %	84 %	55 %	70 %
Joint RSS and TOA	73 %	89 %	62 %	74 %

repeated for each position. The accuracy performance of joint RSS and TOA characteristics is compared with two approaches using only RSS or TOA. Table III presents the comparison results between all positioning techniques.

In order to justify accuracy performance, the choice of error range has been selected. In Table III, 3 and 10 meters are set as comparing targets because it is usually the size of office and meeting rooms, respectively. As seen in Table III, RSS approach gives the worst accuracy while joint approach provides the best results for both inside and outside training area.

VI. CONCLUSION

This paper has been demonstrated the new technique for WLAN positioning system by using joint RSS and TOA characteristics. The proposed technique provides the most convenient way to know the position of user without any extra cost of firmware and hardware. In addition, the accuracy performance is better than using either only RSS or TOA.

REFERENCES

- [1] P. Enge and P. Misra, "Scanning Special Issue/Technology on Global Positioning System," Proc. IEEE, vol. 87, no. 1, 1999.
- [2] M. McGuire, K. Plataniotis, and A. Venetsanopoulos, "Data Fusion of Power and Time Measurements for Mobile Terminal Location," IEEE Trans. Mobile Computing, vol. 4, no. 2, pp. 142-153, Mar.-Apr. 2005.
- [3] T. Roos, P. Myllymaki, and H. Tiri, "A Statistical Modeling Approach to Location Estimation," IEEE Trans. Mobile Computing, vol. 1, no. 1, pp. 59-69, Jan.-Mar. 2002.
- [4] G. Sun, J. Chen, W. Guo, and K.R. Liu, "Signal Processing Techniques in Network-Aided Positioning: A Survey of State-of-the-Art Positioning Designs," IEEE Signal Processing Magazine, vol. 22, no. 4, pp. 12-23, 2005.
- [5] M. Hazas, J. Scott, and J. Krumm, "Location-Aware Computing Comes of Age," Computer, vol. 37, no. 2, pp. 95-97, Feb. 2004.
- [6] J. Hightower and G. Borriello, "Location Systems for Ubiquitous Computing," Computer, vol. 34, no. 8, pp. 57-66, Aug. 2001.
- [7] A. Harter and A. Hopper, "A Distributed Location System for the Active Office," IEEE Network, vol. 8, no. 1, pp. 62-70, 1994.
- [8] M. Hazas and A. Hopper, "Broadband Ultrasonic Location Systems for Improved Indoor Positioning," IEEE Trans. Mobile Computing, vol. 5, no. 5, pp. 536-547, May 2006.
- [9] N.B. Priyantha, A. Chakraborty, and H. Balakrishnan, "The Cricket Location-Support System," Proc. MobiCom, pp. 32-43, 2000.
- [10] M. Youssef and K. Agrawala, "Continuous Space Estimation for WLAN Location Determination Systems," Proc. IEEE 13th Int'l Conf. Computer Comm. and Networks, 2004.
- [11] P. Bahl and V. Padmanabhan, "RADAR: An In-Building RF-Based User Location and Tracking System," Proc. INFOCOM, vol. 2, pp. 775-784, 2000.

- [12] K. Plataniotis and C. Regazzoni, "Visual-Centric Surveillance Networks and Services," IEEE Signal Processing Magazine, special issue on video and signal processing for surveillance networks and services, vol. 22, no. 2, 2005.
- [13] R. Yamasaki, A. Ogino, T. Tamaki, T. Uta, N. Matsuzawa, and T. Kato, "TDOA location system for IEEE 802.11b WLAN," IEEE Wireless Communications and Networking Conference, vol. 4, 13-17 March 2005, pp.2338 – 2343.
- [14] S.A. Golden, and S.S. Bateman, "Sensor Measurements for Wi-Fi Location with Emphasis on Time-of-Arrival Ranging," IEEE Transactions on Mobile Computing, vol 6, no 10, pp.1185 – 1198, Oct. 2007.
- [15] M. Ciurana, S. Cugno, and F. Barcelo-Arroyo, "WLAN indoor positioning based on TOA with two reference points," WPNC '07, 22-22 March 2007, pp. 23 – 28.
- [16] F. Izquierdo, M. Ciurana, F. Barcelo, J. Paradells, and E. Zola, "Performance evaluation of a TOA-based trilateration method to locate terminals in WLAN," 1st International Symposium on Wireless Pervasive Computing, 2006, 16-18 Jan. 2006, pp. 1 – 6.
- [17] M. Yousief, "Horus: A WLAN-Based Indoor Location Determination system," PhD dissertation, Univ. of Maryland, 2004.
- [18] T.S. Rappaport, *Wireless Communications*, Prentice Hall, 2nd,2002.
- [19] P. Raptis, V. Vitsas, K. Paparrizos, P. Chazimisios, and A.C. Boucouvalas, "Packet Delay Distribution of IEEE 802.11 Distributed Coordination Function," IEEE WoWMoM, pp. 299 – 304, 2005.

Dr. Uthansakul received Young Scientist Contest 2nd Prize at 16th International Conference on Microwaves, Radar and Wireless Communications, Krakow, Poland, 22-24 May 2006.



Peerapong Uthansakul (M'07) received B.Eng and M.Eng degrees from Chulalongkorn University, Thailand in 1996 and 1998, respectively. In 1998-2000, he worked as Telecommunication Engineer with Telephone Organization of Thailand (TOT) and then he has joined Suranaree University of Technology since 2000. During 2003-2007, he studied PhD at University of Queensland, Australia, in the area of wireless communications especially MIMO technology.

He currently works as Assistant Professor in school of Telecommunication Engineering, Faculty of Engineering, Suranaree University of Technology, Thailand. He wrote 1 book entitled Adaptive MIMO Systems: Explorations for Indoor Wireless Communications (also available on amazon.com) and he has published more than 60 referee journal and conference papers. His current research interests include MIMO, OFDM, WiMAX and Wireless Mesh Network.

Dr. Uthansakul received 2005 Best Student Presentation Prize winner at the 9th Australian Symposium on Antennas, Sydney, 16-17 February 2005, Australia and 2004 Young Scientist Travel Grant winner at the 2004 International Symposium on Antenna and Propagation, 17-21 August 2004, Japan.



Monthippa Uthansakul (M'07) received B.Eng degree from Suranaree University of Technology, Thailand, in 1997 and M.Eng degrees from Chulalongkorn University, Thailand in 1999. She has joined Suranaree University of Technology since 1999. During 2003-2007, she studied PhD at University of Queensland, Australia, in the area of smart antenna especially wideband beamforming.

She currently works as Assistant Professor in school of Telecommunication Engineering, Faculty of Engineering, Suranaree University of Technology, Thailand. She wrote 1 book chapter entitled Wideband smart antenna avoiding tapped-delay lines and filters in Handbook on Advancements in Smart Antenna Technologies for Wireless Networks, Idea Group Publishing, USA, 2008 and she has published more than 50 referee journal and conference papers. Her current research interests include antenna array processing, compact switched beam antenna and body communications.