

# OXADM Asymmetrical Optical Device: Extending the Application to FTTH System

Mohammad Syuhaimi Ab-Rahman, Mohd. Saiful Dzulkefly Zan, Mohd Taufiq Mohd Yusof

**Abstract**—With the drastically growth in optical communication technology, a lossless, low-crosstalk and multifunction optical switch is most desirable for large-scale photonic network. To realize such a switch, we have introduced the new architecture of optical switch that embedded many functions on single device. The asymmetrical architecture of OXADM consists of 3 parts; selective port, add/drop operation, and path routing. Selective port permits only the interest wavelength pass through and acts as a filter. While add and drop function can be implemented in second part of OXADM architecture. The signals can then be re-routed to any output port or/and perform an accumulation function which multiplex all signals onto single path and then exit to any interest output port. This will be done by path routing operation. The unique features offered by OXADM has extended its application to Fiber to-the Home Technology (FTTH), here the OXADM is used as a wavelength management element in Optical Line Terminal (OLT). Each port is assigned specifically with the operating wavelengths and with the dynamic routing management to ensure no traffic combustion occurs in OLT.

**Keywords**—OXADM, asymmetrical architecture, optical switch, OLT, FTTH.

## I. INTRODUCTION

THE sophisticated technology today has led to realization of any complex design in optical architecture that has become impossible for some years ago. The waveguide technologies become the pioneer in developing the new architecture for optical switching device. The development of optical switching device is expected to be the most promising technologies in realizing a photonic ultralarge data switch network in the near future [1]. The objective of this paper is to introduce of new architecture of switch device that is designed to overcome drawbacks that occur in wavelength management, hence expand the applications in FTTH. The device is called Optical Cross Add and Drop Multiplexing (OXADM) which use combination concept of Optical Cross Connect (OXC) and Optical Add and Drop Multiplexing (OADM) [2]. This is the first reported finding on asymmetrical architecture of optical switching device that enable the operating wavelength on two different optical trunks to be switched to each other and implementing accumulating function simultaneously [3]. Here, the operating wavelengths can be multiplexed together and exit to any

interested output port. Thus, the wavelength transfer between two different cores of fiber will increase the flexibility, survivability and also efficiency of the network structure. To make the device operation more efficient, MEMs switches with lossless and low crosstalk are used to control the mechanism of operation such as wavelength add/drop and wavelength routing operation. As a result, the switching performed within the optical layer will be able to achieve high-speed restoration against failure/degradation of cables, fibers and optical amplifiers which had been proposed in [4]. Previously, we had also proposed the migration of topology which is easier and reduce the restructuring process by eliminating the installation of new nodes because OXADMs are applicable for both types of topologies beside provide efficiency, reliability and survivability to the network [5].

In this paper we highlight on the application of OXADM as the wavelength management in OLT architecture for FTTH system. The multiport offered by OXADM device enable various types of signals to be injected to and stack on the same routing path before send them to the customer premises. This can be implemented by the 'accumulation' function that embedded in the OXADM features. The dynamically selective routing mechanism to ensure the routing management is efficient and systematic. We also demonstrate experimental measurements for OSNR study for single operation on OXADM switch with the values are bigger than 20 dB. Finally, the existing switches (e.g. Directional Coupler and OXC) and OXADM switch are compared.

## II. OXADM DEVICES

OXADMs are element which provide a capabilities of add and drop function and cross connecting traffic in the network, similar to OADM and OXC [6]. OXADM consists of three main subsystem; a wavelength selective demultiplexer, a switching subsystem and a wavelength multiplexer. Each OXADM is expected to handle at least two distinct wavelength channels each with a coarse granularity of 2.5 Gbps or higher (signals with finer granularities are handled by logical switch node such as SDH/SONET digital cross connects or ATM switches). There are eight ports for add and drop functions, which are controlled by four lines of MEMs optical switches. The other four lines of MEMs switches are used to control the wavelength routing function between two different paths. The use of MEMs technology has minimized the effect of crosstalk and return loss. The functions of

Authors are from the Electrical, Electronics and Systems Engineering, Faculty of Engineering, National University of Malaysia (emails: syuhaime@vlsi.eng.ukm.my, saiful@vlsi.eng.ukm.my, mtaufiq@vlsi.eng.ukm.my)

OXADM include node termination, drop and add, routing, multiplexing, providing mechanism of restoration for point-to-point, ring and mesh metropolitan and also customer access network in FTTH. By setting up the MEMs optical switch configuration, the device can be programmed to function as other optical devices such as multiplexer, demultiplexer, coupler, wavelength converter (with fiber grating filter configuration), OADM, wavelength round about and etc for a single application [2].

The designed 4-channel OXADM device is expected to have maximum operational loss of 0.06 dB for each channel when the device components are in ideal condition [7]. The maximum insertion loss when considering the component loss at every channel is less than 6 dB. In the transmission using SMF-28 fiber, with the transmitter power of 0 dBm and sensitivity of -22.8 dBm at a point-to-point configuration with safety margin, the required transmission is 71 km with OXADM [7].

The OXADM architecture consists of 3 parts; selective port, add/drop operation, and path routing. Selective port permits only the interest wavelength passing through it and acts as a filter. By using switch configuration, add and drop function can be activated in second part of OXADM architecture [2].

### III. OXADM OPTICAL SWITCH

The control switch for OXADM Optical Switch is used to change the path of incoming signal from the input port. When the control switches in 'OFF' state, no switching occurs and the signals pass through the device as seen in Fig. 1a. But when the control switch B is in 'ON' state, the signal from Input 1 will be switch to Output 2 (see Fig. 1b). The accumulation function occurs which multiplex all the signals from the inputs and exit at Output 2 [8]. This will be the same if the control switch A is in 'ON' state but the output is at Output 1 in contrast to the control switch B is in reverse state (see Fig. 1c). If both switches are in 'ON' state, the signal will be switched to exchange their output port and works as an OXC device (see Fig. 4b). The functional of an OXADM optical switch can be summarized through the truth functional table shown in Table 1. The incoming signals from the back will be switched to neighbor output port or pass through the device. This is shown in Fig. 2.

### IV. DEVICE COMPARISON

The OXADM device will be compared with two existing switching devices; Directional Coupler (DC) switch and optical cross connect (OXC). The non-selective directional coupler switch has two states and one control element. It has fixed number of input and output port which is two. The wide bandwidth signal comes from the input port will be switched to either one of output ports. It works bi-directional with symmetrical function [9]. Fig. 3 shows the mechanism of switching for Directional Coupler switch in normal (Fig. 3a) and active condition (Fig. 3b). The application of DC switch is

to control the signal path in WDM network and optical storage; and can also perform the function of OADM in optical distributed network [6,9]. Meanwhile, OXC is similar to the DC but with many ports. The function of OXC is cross-connecting between output and input port (Fig. 4) [10]. Same with OXADM, the OXC is selective device but it does not have the accumulation feature. In contrast with OXADM, OXC works bi-directional with symmetrical function. The application of OXC is as a switching device in mesh network configuration and also in optical storage. Table 2 summarizes the differences of OXADM with DC and OXC.

### V. EXPERIMENTAL RESULT

The OXADM device is characterized by using two tunable light sources and two optical spectrum analyzers. The experimental set up is shown in Fig. 8. The designed 4-channel OXADM device is expected to have maximum operational loss of 0.6 dB for each channel when device components are in ideal condition. The maximum insertion loss when considering the component loss at every channel is 6 dB.

The testing is carried out for every single function of OXADM. The function includes bypass, path exchange and accumulation. With single operating wavelength test (wavelength is 1510 nm), the results show that the OSNR value for bypass function is 20 dB (Fig. 1a) and path exchange is also 20 dB. Each measurement result is indicated in Fig. 5 and Fig. 6.

The path splitting function (accumulation function in reverse mode as in Fig. 1b and Fig. 1c) is also applied and the result shown in Fig. 7 with OSNR > 24 dB. For backward operation as depicted in Fig. 8, the OSNR values for cross-connecting function (as Fig. 2) are bigger than 22 dB. This can be defined that the level of signal is 20 dB higher than noise level for all single functions of OXADM optical switch. The 20 dB reference indicates the acceptable value for the signal to noise ratio in data communication.

### VI. APPLICATION: WAVELENGTH MANAGEMENT IN OLT

FTTH Communication is an integrated provider of voice, video and internet services in Minneapolis. Delivering services to residential and business customer on an all-fiber network, the FTTH Communication business plan depends upon a combination of low costs, exceptional service, security and leading-edge technology to increase both the number of subscribers and overall subscriber satisfaction.

Fiber to the Home (FTTH) is a simple, inexpensive, ideal and attractive many parties in optical communication today. It involves the full installment of fiber from central office till to customer houses which is called premises. The technology ensure low Capital Expenditure (CAPEX) and Operational Expenditure (OPEX) because all elements in used are a passive optical device with small number used. The maximum achievable distance is 20 km with Gigabit of transmission rate. FTTH consist of 3 significant elements; Optical Line

Terminal, Optical Splitter and Optical Network Unit as shown in Fig. 9.

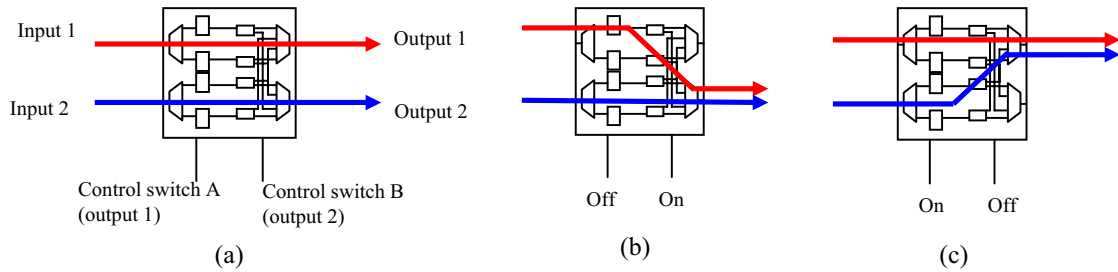

Fig. 1 OXADM Optical Switch works as re-configurable output port multiplexer. (a) Normal condition. (b) Switch B activated – signals accumulate on output 2. (c) Switch B activated - signals accumulate on output 1

TABLE I  
 THE TRUTH TABLE OF OXADM OPTICAL SWITCH

Switch A	Switch B	Output 1	Output 2
0	0	$\lambda_A$	$\lambda_B$
1	0	$\lambda_A + \lambda_B$	X
0	1	X	$\lambda_A + \lambda_B$

0 = Off  
 1 = On  
 $\lambda_A$  = Signal enters input 1  
 $\lambda_B$  = Signal enters input 2  
 X = No signal

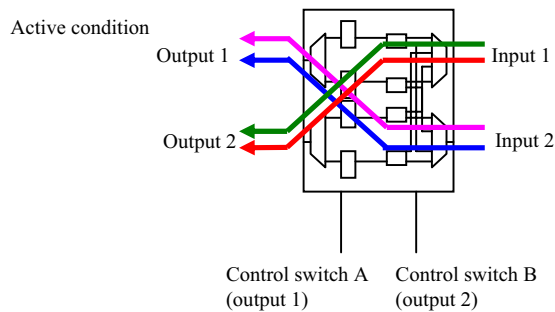

Fig. 2 OXADM Optical Switch works as 2x2 demultiplexer. When the switch is activated, the incoming signals from the back will be switched to any output port

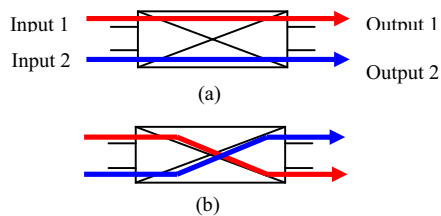

Fig. 3 Switching mechanism in directional coupler optical switch, a) normal (b) activate

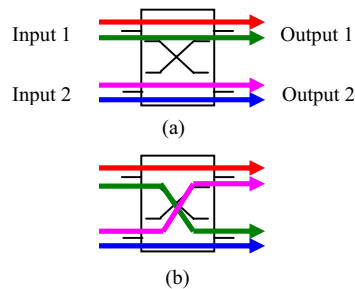
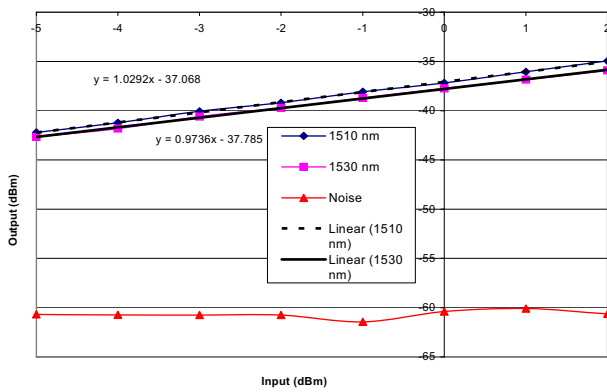

Fig. 4 Switching mechanism in OXC, (a) normal (b) active

TABLE II  
 COMPARISON BETWEEN OXADM, DC AND OXC

Features	OXADM	DC	OXC
Selective Accumulation	Yes	No	Yes
Scalability	Yes	No	No
Symmetrical function	No	Yes	Yes



OSNR 1510 nm = 23.547 dB  
 OSNR 1530 nm = 22.83 dB

Fig. 5 The measured output power at two operating wavelength for bypass operation

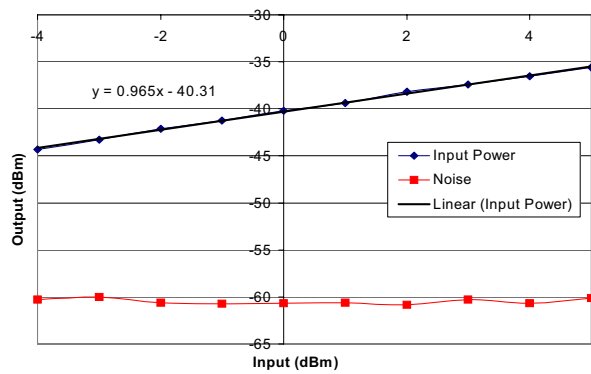

OSNR 1510 nm = 20 dB (Path change)

Fig. 6 The measured output power for path exchange operation

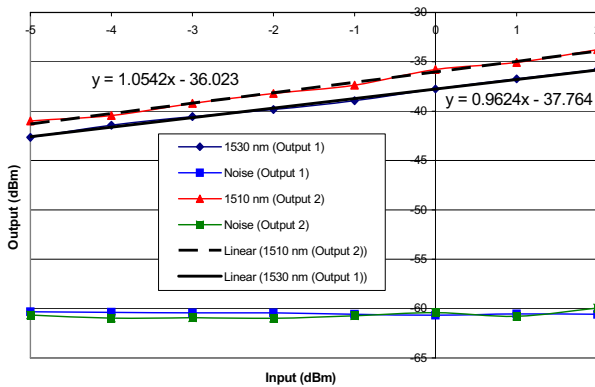
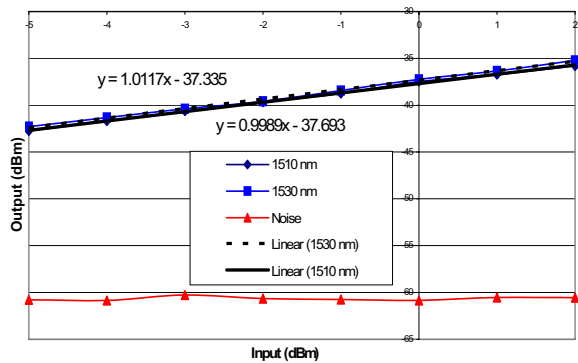

Fig. 7 The measured output power of two operating wavelength for path splitting operation (accumulation function in reverse mode)



OSNR 1510 nm = 22.943 dB (Path change)  
 OSNR 1530 nm = 23.301 dB (Path change)

Fig. 8 The measured output power of two operating wavelength for path exchange operation

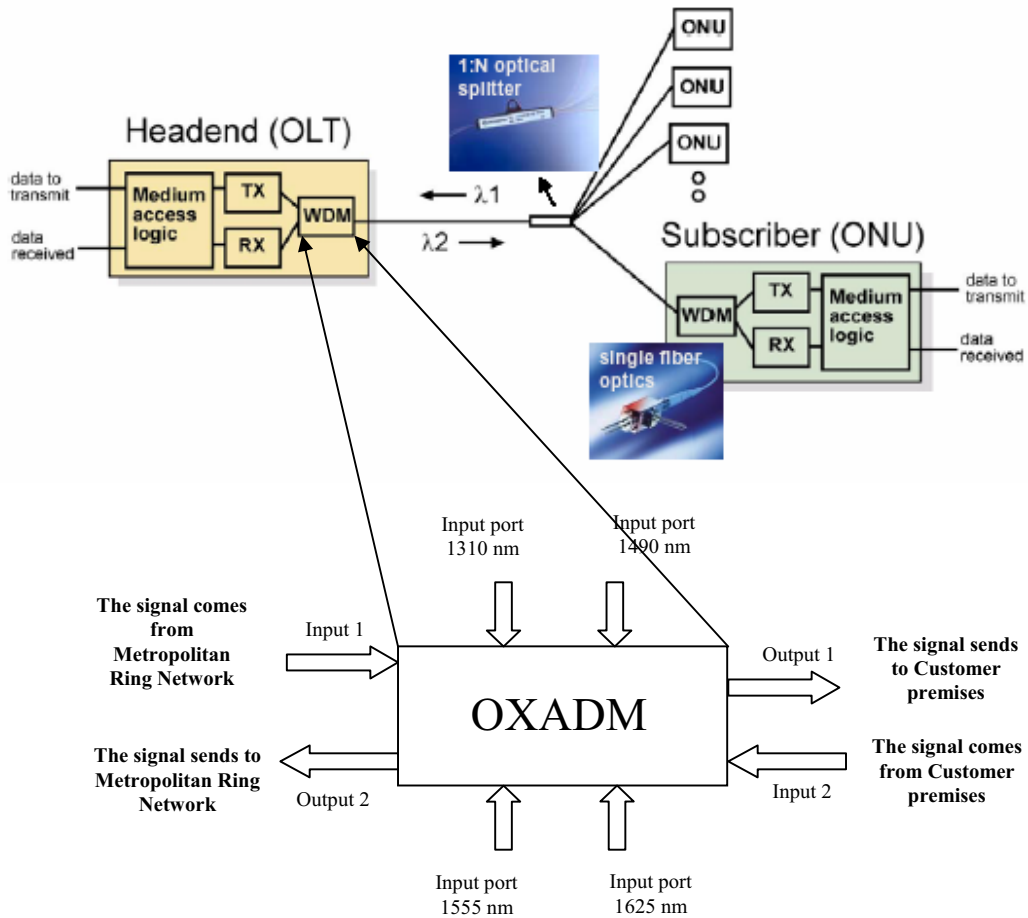

Fig. 9 OXADM function as the wavelength management element in Optical Line Terminal (OLT) in Fiber to-the Home technology

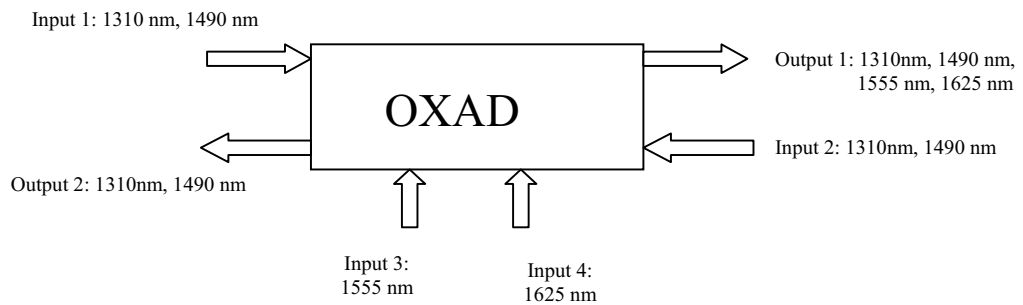

Fig. 10 Receiving data from metropolitan ring network and also from the input terminal 3 and 4. Input terminal 3 and 4 will represent the video signal from satellite TV High-Definition television, HDTV

The designed OXADM is expected to be used as the wavelength management in OLT architecture for excellently FTTH network. It has 4 input terminal which represent the 4 different signal carrier to be multiplexed and exit at Output 1. The signals are then sent to the customer premises. This can be defined in Fig. 9 with the wavelength allocation shown in Fig. 10.

## VII. CONCLUSION

We have introduced a new switching device which utilizes a combined concepts of optical add and drop multiplexing and optical cross connect operation through the development of an optical cross add and drop multiplexer (OXADM). The experimental results show the value of OSNR for every single operation is bigger than 20 dB means that the separation between the signal and noise level is acceptable. Additionally, our previous results have also shown that the value of insertion loss was less than 0.06 dB under ideal condition, the maximum achievable length is 94 km. While when considering the loss, with the transmitter power of 0 dBm and sensitivity of -22.8 dBm at a point-to-point configuration with safety margin, the required transmission is 71 km with OXADM [7]. The OXADM switching mechanism has been explained and compare with other existing optical switch; directional coupler optical switch and OXC.

We have proposed the OXADM switching device to be used in OLT architecture as the wavelength management system for FTTH technology. The accumulation features ensure the dynamic routing mechanism will be increase systematically. OXADM enable all types of signal (triple play) to be assigned with particular port and can be configured at the exit port.

The OXADM optical device is particularly designed for Wavelength-Division Multiplexing (WDM) metro application. Previously, we also proposed that it can be used as a restoration switch in FTTH network particularly covering the drop region (area between Optical Splitter and Optical Network Unit-ONU). OXADM can also work as any single device such as demultiplexer, multiplexer, OADM, OXC and Wavelength Selective Coupler (WSC) [2].

In other application, the OXADM can also provide survivability through restoration against failure by means of dedicated and shared protection that can be applied in WDM ring metropolitan network [4].

## ACKNOWLEDGMENT

This project is supported by Ministry of Science, Technology and Environment, Government of Malaysia, through the National E-Science Project fund 01-01-02-SF0493 and Research University Grant fund UKM-GUP-TMK-07-02-108.

## REFERENCES

- [1] T. Kirihaara, M. Ogawa, H. Inoue, K. Ishida. Lossless and low-crosstalk characteristics in an InP-based 2x2 Optical switch. *IEEE Photonics Technology Letter*, Vol. 5. No. 9, pp. 1059-1061, 1993.
- [2] M.S. Ab-Rahman, A.A. Ehsan, S. Shaari. Optical multifunctional device with OXADM. *Regional Symposium on Microelectronics*, pp. 540-544, 2007.
- [3] M.S. Ab-Rahman, S. Shaari. The bi-directional characteristic of asymmetrical Optical Cross Add and Drop Multiplexer (OXADM) architecture. *Regional Symposium on Microelectronic.*, pp. 429-435, 2007.
- [4] M.S. Ab-Rahman, S. Shaari. OXADM restoration scheme: Approach to optical ring network protection. *IEEE International Conference on Networks*, pp. 371-376, 2006.
- [5] M.S. Ab-Rahman, A.A. Ehsan, S. Shaari. Mesh upgraded Ring in metropolitan network using OXADM. *Proceeding of the 5th International Conference on Optical Communications and Networks & the 2nd International Symposium on Advances and Trends in Fiber*, pp. 225-227. 2006.
- [6] L. Eldada, J.V Nunen. Architecture and performance requirements of optical metro ring nodes in implementing optical add/drop and protection functions. *Telephotonics Review*, 2000
- [7] M.S. Ab-Rahman, A.A. Ehsan, S. Shaari. Analytical modeling of optical cross add and drop multiplexing switch. *Proceeding 2006 IEEE International Conference on Semiconductor Electronics*, pub. IEEE Malaysia Section, pp. 290-293, 2006.
- [8] M.S. Ab-Rahman, S. Shaari. The new architecture of optical switch device. *Regional Symposium on Microelectronics*, pp. 535-539, 2007.
- [9] J.C. Palais. *Fiber optic communication*. New Jersey: Prentice Hall, 2005.
- [10] E. Mutafungwa. An improved wavelength-selective all fiber cross-connect node. *IEEE Journal of Applied Optics*, pp. 63-69, 2000.

**Mohammad Syuhaimi Ab-Rahman** received the B.Eng, M.Sc and PhD degrees in electrical, electronic and system from National University of Malaysia, in 2000, 2003, 2007 respectively. He joined the Institute of Micro-Engineering and Nanoelectronics (IMEN) in 2003. He is currently a senior Lecturer in National University of Malaysia (UKM), Selangor, Malaysia. He is also an associated research fellow of IMEN since 2006. His current research interests are in the area of photonic networks and optical communication technologies such as optical security nodes, device fabrication, active night vision, plastic optical fiber, fiber to the home, fiber in automotive and optical code-division multiplexing.

**Mohd Taufiq Mohd Yusof** received his BEng in 2006 from Intenational Islamic University Malaysia and MSc from University of Southampton, UK in 2008. He has been appointed as a lecturer in National University of Malaysia since 2007. His research interests include intelligent system, MEMS technology, microelectronics system design and optical devices.

**Mohd Saiful Dzulkefly Zan** obtained BEng from Waseda University, Japan in 2006. He has been appointed as assistant lecturer in National University of Malaysia since 2007. The current and interest is in the field of photonic technology, fiber optic communication and optical devices.