

# Performance Analysis of HSDPA Systems using Low-Density Parity-Check (LDPC) Coding as Compared to Turbo Coding

K. Anitha Sheela, J. Tarun Kumar

**Abstract**—HSDPA is a new feature which is introduced in Release 5 specifications of the 3GPP WCDMA/UTRA standard to realize higher speed data rate together with lower round-trip times. Moreover, the HSDPA concept offers outstanding improvement of packet throughput and also significantly reduces the packet call transfer delay as compared to Release 99 DSCH. Till now the HSDPA system uses turbo coding which is the best coding technique to achieve the Shannon limit. However, the main drawbacks of turbo coding are high decoding complexity and high latency which makes it unsuitable for some applications like satellite communications, since the transmission distance itself introduces latency due to limited speed of light. Hence in this paper it is proposed to use LDPC coding in place of Turbo coding for HSDPA system which decreases the latency and decoding complexity. But LDPC coding increases the Encoding complexity. Though the complexity of transmitter increases at NodeB, the End user is at an advantage in terms of receiver complexity and Bit- error rate. In this paper LDPC Encoder is implemented using “sparse parity check matrix” H to generate a codeword at Encoder and “Belief Propagation algorithm” for LDPC decoding. Simulation results shows that in LDPC coding the BER suddenly drops as the number of iterations increase with a small increase in Eb/No. Which is not possible in Turbo coding. Also same BER was achieved using less number of iterations and hence the latency and receiver complexity has decreased for LDPC coding. HSDPA increases the downlink data rate within a cell to a theoretical maximum of 14Mbps, with 2Mbps on the uplink. The changes that HSDPA enables includes better quality, more reliable and more robust data services. In other words, while realistic data rates are only a few Mbps, the actual quality and number of users achieved will improve significantly.

**Keywords**—AMC,HSDPA,LDPC,WCDMA,3GPP.

## I. INTRODUCTION

OF all the tremendous advances in wireless communications from the introduction of its First Generation in 1980's, mobile communication technology has developed a long way over three decades. In each generation, transmission rates and services, among other things, are improved. HSDPA introduced a new common High Speed Downlink Shared Channel (HSDSCH) shared by several users. The introduction of this new transport channel impacts several protocol layers; the most significant changes are in

K.Anitha sheela is with Department of Electronics and Communication ,Jawaharlal Nehru Technological University ,Hyderabad-500001,India( phone: 91-9441189219 e-mail:kanithasheela@gmail.com).

J.Tarun Kumar is with Department of Electronics and Communication ,Ramappa Engineering College Warangal-506001,India ( phone: 91-9866258045 e-mail:tarunjuluru@yahoo.com).

the physical and MAC layers [2]. WCDMA technology, which provides the radio interface in the 3G UMTS mobile system defined by the 3GPP, theoretically it can deliver peak data rates up to 2.4 Mb/s. In actual networks, though, the average data throughput rate reportedly doesn't go much beyond 384 kb/s. Release 5 of the 3GPP WCDMA specification adds HSDPA technology in an effort to make the system more efficient for bandwidth-intensive data applications.

A WCDMA network upgraded to HSDPA will support downlink data rates well over 2 Mb/s, up to a theoretical 14 Mb/s [[1], [2]]. Because the new technology is backward compatible with 3GPP Release 99, voice and data applications developed for WCDMA still can be run on the upgraded networks, and the same radio channel will support WCDMA and HSDPA services simultaneously. HSDPA increase WCDMA downlink speeds by a factor of five, double the network capacity, and support a greater number of users on the network. With these significant improvements for data, WCDMA systems will be able to shift gears and move ahead to the enhanced performance enabled by this latest inter-generational mobile communication technology.

High Speed Downlink Packet Access (HSDPA) is a concept included in WCDMA 3GPP (Third Generation Partnership Project) Release 5 specifications [3]. The main target is to increase the user peak data rates and quality of service (QoS), and in general improve the spectral efficiency for downlink asymmetrical and busty packet data services. When HSDPA will be implemented, it can coexist on the same carrier as the current Release 99 WCDMA services. This will enable a smooth and cost efficient introduction of HSDPA into the existing WCDMA networks. The driving force for high data rates are greater speed, shorter delays when downloading audio, video and large files which will be used in PDA's, smart phones etc. Further a user can download packet data over HSDPA, while at the same time having a speech call. HSDPA offers theoretical peak rates of up to 10MB/s and in practice more than 2Mbps[7].

The technical aspects behind the HSDPA concept include the following: Adaptive Modulation and Coding (AMC), Shared channel transmission, Fast Hybrid Automatic Repeat Request (H-ARQ), Fast cell site selection (FCSS) and Short transmission time interval (TTI),Fast scheduling at Node B.

High Speed Downlink Packet Access (HSDPA) was finalized by the 3GPP as part of the Release 5 specifications back in 2003, and over the past year has undergone a number of high-profile field trials with cellular operators. Full commercial services are expected to be operational in some countries by the end of the year. Designed as an upgrade to the existing 3G networks, HSDPA offers theoretical data rates up to 14 Mb/s and reduced latencies to support real-time applications. HSDPA doesn't just provide the user with improved services. The technology introduces a number of techniques that let network operators use and manage their valuable radio spectrum more efficiently. While existing established cellular systems attempt to transmit the data independently of channel conditions, using brute

force techniques based on more power to overcome deep fades, HSDPA applies some intelligence to problem [7]. In fact, by considering multi-user diversity, HSDPA targets the highest data rates towards users with the best instantaneous channel quality. In addition, it introduces enablers for the high speed transmission at the physical layer like the use of a shorter TTI (2 ms), the use of adaptive modulation and coding, and the use of fast retransmission based on hybrid ARQ (HARQ) techniques. The scheduler has not been standardized in 3GPP and Nortel proposes a two stage scheduler integrating the subscriber's differentiation. With this "packetized" air interface, more users are on a cell and the scheduler is more efficient by having more opportunity to deal with a constructive fading. This is the Multi-User Gain of the HSDPA scheduler. In many aspects, the new transport channel type HS-DSCH is very similar to the DSCH transport channel. As in DSCH, the HS-DSCH transport channel is associated to a dedicated DPCH channel (in the uplink for HS-DSCH, contrary to DSCH) [6]. To improve WCDMA system performance, HSDPA makes a number of changes to the radio interface that mainly affects the physical and transport layers: Shorter radio frame, new high-speed downlink channels, Use of 16 QAM in addition to QPSK modulation, Fast link adaptation using AMC, use of HARQ. Each frame is encoded using a LDPC code, interleaved, and modulated to symbols. Channel coding done by LDPC codes is the best method for transmitting information with fewer errors and lower signal power [8]. LDPC encoding using sparse parity check matrix decoding has been implemented using "Belief Propagation algorithm"[10]. We have taken this coding scheme as our area of interest and shown how it helps HSDPA in achieving its goal.

## II. BASIC FEATURES OF HSDPA

### A. Adaptive Modulation and Coding (AMC)

Link adaptation in HSDPA is the ability to adapt the modulation scheme and coding according to the quality of the radio link. Basically link adaptation is required because, in cellular communication systems the SNR of the received signal at the UE (Mobile Equipment is called User Equipment for 3rd generation mobile systems) varies over time by as much as 30-40 dB due to fast fading and geographic location in a particular cell. In order to overcome this fading effect and improve the system capacity and peak data rates, the transmitted signal to a particular UE is modified in accordance with the signal variations through a process called link adaptation. In present WCDMA networks fast power control is used for radio link adaptation. This power control is done per slot in WCDMA. But in HSDPA the transmission power is kept constant over the TTI (length of the frame is referred to as Transmit Time Interval) and uses adaptive modulation and Coding (AMC) as an alternative method to power control in order to improve the spectral efficiency [7]. HSDPA uses higher order modulation schemes like QPSK, 16-QAM. The modulation to be used is adapted according to the radio channel conditions. QPSK can support 2 bits/ symbol where as 16QAM can support 4 bits/ symbol, and hence twice the peak rate capability as compared to QPSK, using the channel bandwidth more efficiently. Different code rates used are 1/4, 1/2, 5/8, 3/4. The Node-B (Base Station) receives the Channel Quality indicator (CQI) report and power measurements on the associated channels. Based on these information it determines the transmission data rate. In HSDPA, users close to the Node-B are generally assigned higher modulation with higher code rates (e.g. 16QAM and 3/4 code rate), and both decreases as the distance between UE and Node-B increases [8].

### B. Shared Channel Transmission

The HSDPA concept introduced few additional physical channels. They are High Speed Physical Downlink Shared Channel (HS-PDSCH) and a dedicated HS-Physical Control Channel (HS-DPCCH).

HS-PDSCH: This channel is both time and code shared between users attached to a Node-B. It is the transport mechanism for additional logical channels; they are HS Downlink Shared Channel (HSDSCH) and HS-Shared Control Channel (HSSCCH). The HS-DSCH code resources consist of one or more channelization codes with a fixed spreading factor (SF) of 16. At the most 15 such codes can be allocated leaving sufficient room for other required control and data carriers. The available code resources are primarily shared in time domain but it is possible to share the code resources using code multiplexing [4]. When it is both time and code shared, two to four users can share the code resources with the same TTI.

HS-DPCCH: This channel is an uplink channel used to carry the acknowledgement signals to the Node-B for each block. It is also used to indicate the Channel Quality (CQI) which is used for Adaptive Modulation and Coding.

### C. Fast Hybrid Automatic Repeat Request (H-ARQ)

Simple form of hybrid ARQ shows significant gains over link adaptation alone through e.g. Chase combining. Hybrid ARQ self-optimizes and adjusts automatically to channel conditions without requiring frequent or highly accurate C/I measurements: 1) Adds redundancy only when needed; 2) Receiver saves failed transmission attempts to help future decoding; 3) every transmission helps to increase the packet success probability. N Channel Stop-and-Wait Protocol parallelizes the top-and-wait protocol and in effect runs a separate instantiation of the Hybrid ARQ protocol when the channel is idle.

The advantages include the following: 1) no system capacity goes wasted since one instance of the algorithm communicates a data block on the forward link at the same time that the other communicates an acknowledgment on the reverse link; 2) UE memory requirements can be made low by choosing low value of N. Three different methods for N-channel HARQ: 1) Signal the sub channel number explicitly (fully asynchronous); 2) Tie the sub channel number to e.g. frame timing (partially asynchronous); 3) UE does not have flexibility to re-schedule re-transmissions i.e. retransmissions occur immediately in the next allowed slot (synchronous). Choice of HARQ methods will depend on: 1) Ease of implementation; 2) TTI size; 3) Buffering complexity at the UE; 4) Processing time at Node-B and UE.

### D. Fast Cell Site Selection (FCSS)

Typically on an average 20-30% of the MS's are in soft or softer handover condition. Soft handover is a handover between two Node-B's where as softer hand over is between sectors of a Node-B. So it's very important to track the active set of Node-B's connected to a UE for communication. FCSS allows a UE to select the Node-B with the best current transmission characteristics [UMTS evolution to HSDPA]. The advantage of this system is that higher data rates can be achieved at most of the time.

### E. Short Transmission Time Interval (TTI)

The length of the frame is referred to as Transmission Time Interval (TTI). The HS-DSCH which is added in the HSDPA standard uses this TTI of 2ms than the Release'99 transport channel TTI. This is done to reduce the round trip time, increases the granularity in the scheduling process and for better tracking of the time varying radio

channel. Actually the length of the frame is variable and is selected based on traffic supported and the number of supported users. A typical value is 2ms.

#### F. Fast and Fair Scheduling at Node B

Typically in WCDMA networks the packet scheduling is done at the RNC (radio network connection), but in HSDPA the packet scheduler (medium access layer-hs) is shifted to the Node-B. This makes the packet scheduling decisions almost instantaneous. In addition to this, the TTI length is shortened to 2ms. Hence the scheduling is done very fast as its done every TTI. A first approach for fair scheduling can be Round-Robin method where every user is served in a sequential manner so all the users get the same average allocation time. However, it requires high scheduling rate along with the large AMC availability with the HSDPA concept, where the channel is allocated according to the instantaneous channel conditions [7]. Another popular packet scheduling is proportional fair packet scheduling. Here, the order of service is determined by the highest instantaneous relative channel quality. Though the selection is based on relative conditions, still every user gets approximately the same amount of allocation time depending on its channel condition.

### III. TURBO CODES

Turbo codes are the more general family of codes on graphs with iterative decoding algorithms. The main idea behind codes on graphs was introduced by Gallager in the early 1960's. However, at that time these coding techniques were thought impractical and were generally not pursued by researchers in the field.

Turbo codes consist of two key components: parallel concatenated encoding and iterative, "turbo" decoding[14]. A typical parallel concatenated encoder consists of two parallel convolutional encoders separated by an interleaver, with the input to the channel being the data bits  $m$  along with the parity bits  $X1$  and  $X2$  output of the encoders in response to input  $m$ . Since the  $m$  information bits are transmitted as part of the codeword, the parallel concatenated encoding lies in the recursive nature of the encoders and the impact of the interleaver on the information stream.

Turbo decoding or iterative decoding exploits the component-code substructure of the turbo encoder by associating a component decoder with each of the component encoders. More specifically, each decoder performs soft input/soft output decoding.

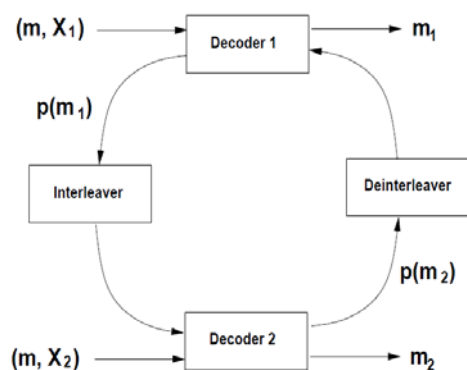

Fig.1 Turbo Decoder

In this Fig.1 Decoder 1 generates a soft decision in the form of a probability measure  $P(m1)$  on the transmitted information bits based on the received codeword  $(m, X1)$ . The probability measure is generated by either a minimum a posteriori (MAP) probability algorithm or a soft output Viterbi algorithm (SOVA). This reliability

information is passed to Decoder 2, which generates its own probability measure  $P(m2)$  from its received codeword  $(m, X2)$  and the probability measure  $P(m1)$ . This reliability information is input to Decoder 1, which revises its measure  $P(m1)$  based on this information and the original received codeword. Decoder 1 sends the new reliability information to Decoder 2, which revises its measure using this new information. Turbo decoding proceeds in an iterative manner, with the two component decoders alternately updating their probability measures. Ideally the decoders eventually agree on probability measures that reduce to hard decisions  $m = m1 = m2$ . However, the stopping condition for turbo decoding is not well-defined in part, because there are many cases in which the turbo decoding algorithm does not converge; i.e., the decoders cannot agree on the value of  $m$ .

### IV. LDPC CODING

Low density parity check (LDPC) codes were originally invented by Gallager in his Masters thesis in 1961 [10]. However, these codes were largely ignored until the introduction of turbo codes. The fundamental practical difference between turbo codes and LDPC codes is that turbo codes tend to have low encoding complexity (linear in block length) but high decoding complexity (due to their iterative nature and message passing).

LDPC codes are like all linear block codes they can be described via matrices. And second possibility is a graphical representation.

#### A. Matrix Representation

The matrix represented is a parity check matrix with dimension  $n \times m$  for example a  $(8, 4)$  code in equation (1). We can now define two numbers describing these matrix,  $w_r$  for the number of 1's in each row and  $w_c$  for the columns. For a matrix to be called low-density

$$H = \begin{bmatrix} 0 & 1 & 0 & 1 & 1 & 0 & 0 & 1 \\ 1 & 1 & 1 & 0 & 0 & 1 & 0 & 0 \\ 0 & 0 & 1 & 0 & 0 & 1 & 1 & 1 \\ 1 & 0 & 0 & 1 & 1 & 0 & 1 & 0 \end{bmatrix} \quad (1)$$

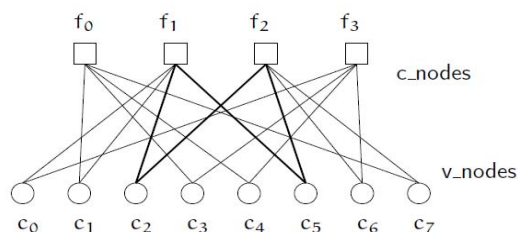

Fig.2 Tanner graph corresponding to the parity check matrix

The two conditions  $w_c \ll n$  and  $w_r \ll m$  must be satisfied. In order to do this, the parity check matrix should usually be very large, so the example matrix can't be really called low-density.

Tanner graphs provide complete representation of the LDPC code. These graphs are bipartite graphs. That means the nodes of the graph are separated into two distinctive sets, and edges are only connecting nodes of two different types. The two types of nodes in a Tanner graph are called variable nodes (v-nodes) and check nodes (c-nodes) Fig.2 is an example for such a Tanner graph and represents the same code as the matrix in equation 1. The creation of such a graph is rather straight forward. It consists of  $m$  check nodes (the number of parity bits) and  $n$  variable nodes (the number of bits in a codeword). Check node  $f_i$  is connected to variable node  $c_j$  if the element  $h_{ij}$  of  $H$  is 1.

### B. Decoding Algorithm: Belief Propagation

The algorithms used to decode LDPC codes are the Belief propagation algorithm, Message passing algorithm and Sum-product algorithm. Soft-decision decoding which is based on the concept of Belief propagation for LDPC coding yields better decoding performance and is therefore the preferred method. Before presenting the algorithm lets introduce the following parameters

- a)  $P_i = P_r(c_i = 1|y_i)$  Probability of  $i^{\text{th}}$  received bit of column  $c$
- b)  $q_{ij}$  is a message sent by the variable node  $c_i$  to the check node  $f_j$ . Every message contains always the pair  $q_{ij}(0)$  and  $q_{ij}(1)$  which stands for the amount of belief that  $y_i$  is a "0" or a "1" message sent by the variable node  $c_i$  to the check node  $f_j$ .
- c)  $r_{ji}$  is a message sent by the check node  $f_j$  to the variable node  $c_i$ . Again there is a  $r_{ji}(0)$  and  $r_{ji}(1)$  that indicates the (current) amount of belief in that  $y_i$  is "0" or "1".

### C. Decoding Steps

1. All variable nodes send their  $q_{ij}$  messages. Since no other information is available at this step,  $q_{ij}(1) = P_i$  and  $q_{ij}(0) = 1 - P_i$ .

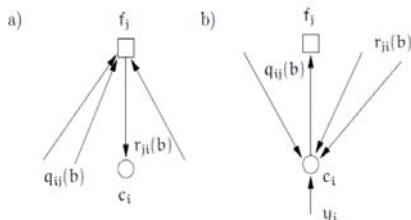

Fig.3a) Illustrates the calculation of  $r_{ji}(b)$  and b)  $q_{ij}(b)$

2. The check nodes calculate their response messages  $r_{ji}^2$

$$r_{ji}(0) = \frac{1}{2} + \frac{1}{2} \prod_{i' \in V_j \setminus i} (1 - 2q_{i'j}(1)) \quad (2)$$

and

$$r_{ji}(1) = 1 - r_{ji}(0) \quad (3)$$

3. The variable nodes update their response messages to the check nodes. This is done according to the following equations, So they calculate the probability that there is an even number of 1's among the variable nodes except  $c_i$  (this is exactly what  $V_{ji}$  means). This probability is equal to the probability  $r_{ji}(0)$  that  $c_i$  is a '0'. This step and the information used to calculate the responses are illustrated in Fig.3.

$$q_{ij}(0) = K_{ij} (1 - P_i) \prod_{j' \in C_i \setminus j} r_{ji'}(0) \quad (4)$$

$$q_{ij}(1) = K_{ij} P_i \prod_{j' \in C_i \setminus j} r_{ji'}(1) \quad (5)$$

The constant  $K_{ij}$  is chosen in a way to ensure that  $q_{ij}(0) + q_{ij}(1) = 1$ .  $C_{ij}$  now means all check nodes except  $f_j$ . Again Fig.3 illustrates the calculation in this step. At this point the v-nodes also update their current estimation of their variable  $c_i$ . This is done by calculating the probabilities for 0 and 1 and voting for the bigger one. The used equations

$$Q_i(0) = K_i (1 - P_i) \prod_{j \in C_i} r_{ji}(0) \quad (6)$$

and

$$Q_i(1) = K_i P_i \prod_{j \in C_i} r_{ji}(1) \quad (7)$$

Which are quite similar to the ones to compute  $q_{ij}(b)$  but now the information from every c-node is used

$$\hat{c}_i = \begin{cases} 1 & \text{if } Q_i(1) > Q_i(0), \\ 0 & \text{else} \end{cases} \quad (8)$$

The algorithm terminates if the current estimated codeword fulfills the parity check equations. Otherwise termination is ensured through maximum number of iterations.

### V. SYSTEM MODEL

The simulation model used is represented in Fig.4. On the transmitter side, the generated user data is spread with spreading factor of 16. This sequence of chipped data is then encoded by a LDPC codes, encoder operating with code rate=1/2. Before propagating through a Gaussian-noise channel, the encoded signal is modulated with QPSK, which is supported by HSDPA. The channel is simple Additive White Gaussian Noise (AWGN), without fading.

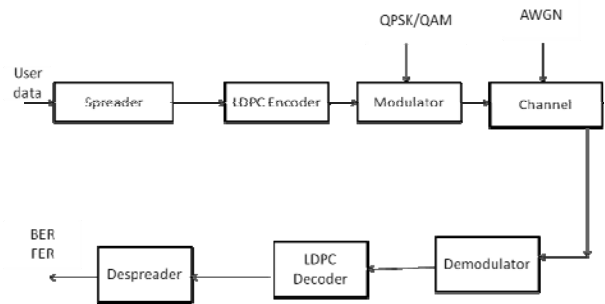

Fig.4 HSDPA Proposed System Model

On receiver side, the received signal is first demodulated by a Detector before passing through a LDPC Channel Decoder to get spreaded data. To reproduce the user data, the spreaded data is despreaded by a Despreader. In practice, the system is unable to reproduce exactly the transmitted data due to the noise introduced in the transmission channel. There may be some bits received erroneously. The level of bit errors and frame errors, are reflected by the Bit Error Rate and Frame Error Rate measured at the receiver.

### VI. SIMULATION RESULTS

To achieve the optimized results, the program is simulated with different number of iterations. Fig. 5, 6 depicts the relation between the BER and  $E_b/N_0$ , FER and  $E_b/N_0$  simulated at 10 iterations, similarly Fig. 7,8 for 20 iterations and Fig. 9,10 for 50 iterations. As  $E_b/N_0$  increases BER and FER decreases. The LDPC decoder will reduce the BER. As the number of iterations increase there is a sudden drop in the BER. For the iterations 50, the BER is extremely low. The simulations are performed with QPSK Modulation for a TTI of 2ms and code rate of 1/2.

It is observed that for 10 iterations as the  $E_b/N_0$  is increasing to 3dB the BER achieved is less than  $10^{-4}$ , for 20 iterations the slope of the curve is approaching nearly  $10^{-4}$ . Similarly for 50 iterations the BER is suddenly dropped to greater than  $10^{-4}$  for which  $E_b/N_0$  is 3.

The theoretical results of turbo decoder are placed in Fig.11 for various iterations. These results indicate several important aspects of turbo codes. Even though good BER results are obtain the major drawback of these turbo decoders, the stopping condition of turbo

decoder is not well defined. Also even if the received code word is correct the turbo decoding performs the iterative operations.

The programme is simulated in Mat lab 7.0 using P-IV processor with 1GB RAM. It took an average time of 1.23s for 10 iterations, 2.54s for 20 iterations and 5.08s for 50 iterations, from which it is observed that the latency of the system is reduced.

HSDPA is a new technology and its standards have not been frozen yet. Hence, its performance in real time environment is not yet known.

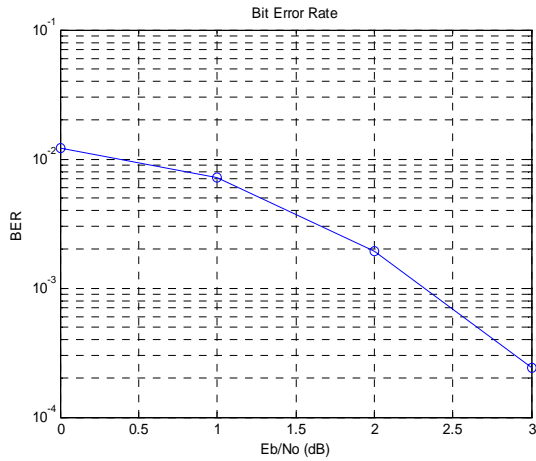

Fig.5: For 10 iterations

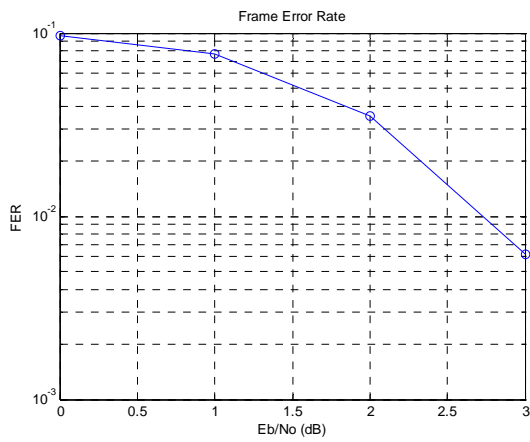

Fig.6 For 10 iterations

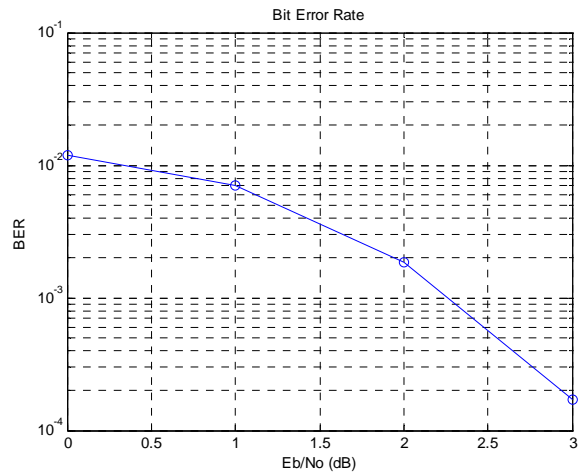

Fig.7 For 20 iterations

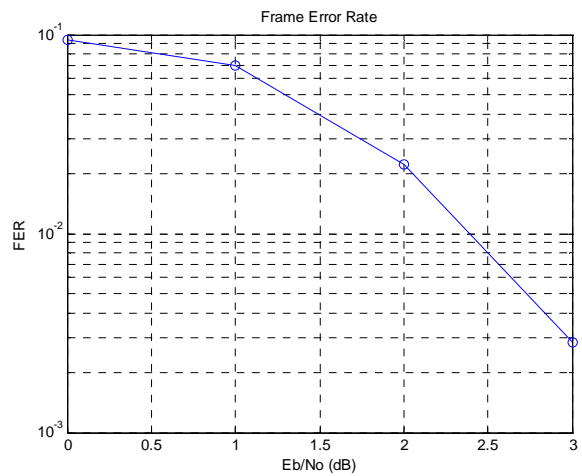

Fig.8 For 20 iterations

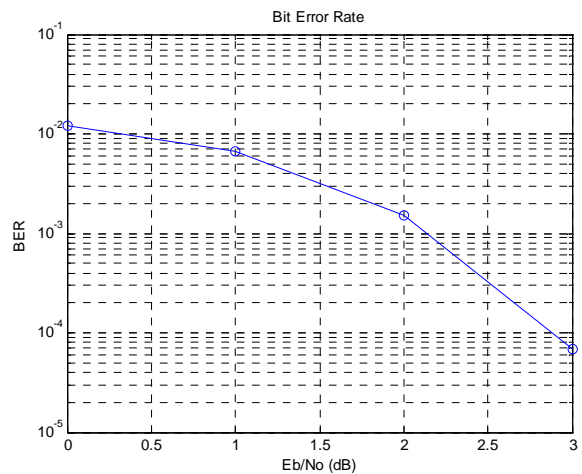

Fig.9 For 50 iterations

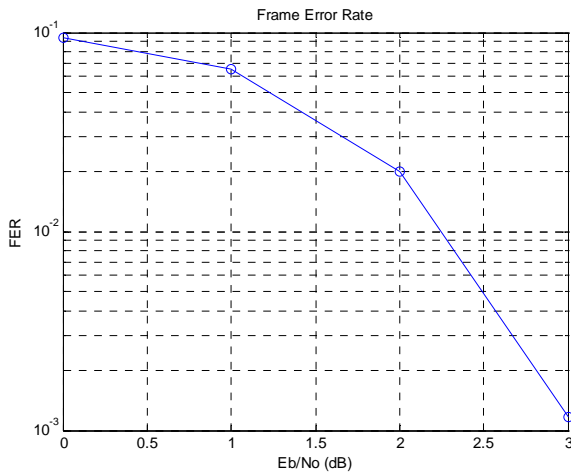

Fig.10 For 50 iterations

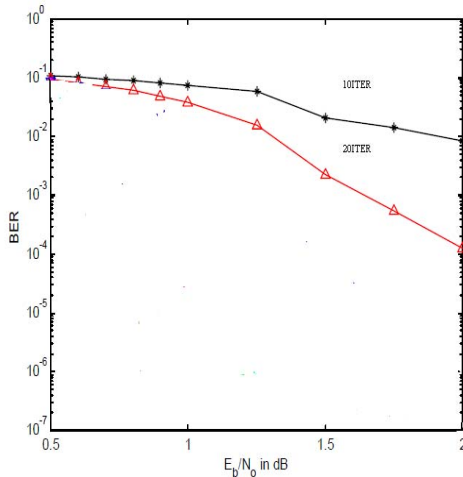

Fig.11 Theoretical results of turbo decoder

## VII. CONCLUSION & FUTURE SCOPE

This paper developed and simulated on HSDPA system with a new class of channel coding using LDPC. The performance of HSDPA using LDPC has been observed. By using these simulated results. The time taken to simulate the large number of iterations is less as compared to turbo coding which makes the system faster at receiver by reducing the latency, as only 3 parameters need to be updated at each iteration of the decoding cycle of LDPC which are  $Q_i$ ,  $q_{ij}$  and  $r_{ji}$ . Hence the receiver complexity is reduced. The performance of HSDPA has been evaluated only for QPSK. It can be done with 16QAM but due to complexity of the features like AMC, HARQ and Scheduling at Node B the 16 QAM modulation is not included in our program.

HSDPA technology is incorporated in WCDMA Release'5 to increase data throughput and improve the efficiency of the system for downlink traffic. To achieve these features effectively the advanced techniques like AMC, HARQ and scheduling at Node B etc. need to be incorporated into HSDPA technique. With these advancements the engineers can successfully implement HSDPA system into network and User equipment.

## REFERENCES

- [1] T. Ojanpera and R.Prasad, "An overview of air interface multiple access for IMT- 2000/UMTS", IEEE Commun. Mag., vol. 36, pp. 82-95, Sept. 1998.
- [2] Simon Binar., Tektronix Inc, "HSDPA and HSUPA Functional Testing", Protocol Monitoring Division, Berlin, Germany, 2006.
- [3] Niyato, D Hossain, E Wavegedara, K.C. Bhargava, "Radio Link Level Performance in Multi-Rate MIMO Wireless Networks: Analysis and Optimization", Wireless Comm. and Networking Conference, 2007.WCNC 2007. IEEE vol , Issue , 11-15 March 2007 ,pp294 – 298.
- [4] Claude Berrou, Alain Glavieux, "Near Optimum Error Correcting Coding and Decoding: Turbo Codes", IEEE Transactions on Communication, Vol.44, No.10, October 1996.
- [5] Che-Sheng Chiu and Chen-Chiu Lin, "Comparative downlink shared channel performance evaluation of WCDMA release 99 and HSDPA", IEEE International Conference; year 2004 , vol. 2 , pages 1165-1170.
- [6] 3GPP TR 25.858 V1.0.0 (2001-12), Physical layer aspects of UTRA High Speed Downlink Packet Access, Release 5..Ratio Combining (MRC) which is a receiver diversity estimator.
- [7] J. R. Fonollosa, M. Heikkilä, X. Mestre, A. Pagès, A. Pollard, L.Schumacher, A. Wiesel and J. Ylitalo, "Adaptive Modulation Schemes for MIMO HSDPA," IST Mobile & Wireless Telecommunications Summit 2002, Thessaloniki, Greece, June 2002.
- [8] B. Hassibi and Bertrand M. Hochwald. "High rate codes that are linear in space and time", IEEE Trans. Info.Theory, April 2001.
- [9] Robert C, Qiu, Wenwu Zhu,a-Qin Zhang, "Third-Generation and Beyond (3.5G) Wireless Networks and Its Applications", IEEE International Symposium on Circuits and Systems (ISCS), Scottsdale, Arizona, May 26-29
- [10] R. G. Gallager, " Low Density Parity-Check Codes". MIT Press, Cambridge, MA, 1963.
- [11] Amin Shokrollahi, "LDPC Codes: An Introduction. Digital Fountain", Inc.39141 Civic Center Drive, Fremont, CA 94538MIT Press, Cambridge, MA, 1963.
- [12] Thomas J. Richardson and Rüdiger L. Urbanke. "The Capacity of Low-Density Parity-Check Codes Under Message-Passing Decoding", IEEE Trans. Info.Theory, vol. 47, no. 2, Feb 2001.
- [13] David J.C. Mackay, "Near Shannon Limit Performance Of Low Density Parity Check Codes", Cavendish Laboratory, Cambridge, UK. Published in Electronics letters, Jul 1996.
- [14] Andrea Goldsmith, "WIRELESS COMMUNICATIONS", Cambridge University Press, 2005. pp. 229–243.