

# A Novel Adaptive Voltage Control Strategy for Boost Converter via Inverse LQ Servo-Control

Sorawit Stapornchaisit, Sidshchadhaa Aumted, and Hiroshi Takami

**Abstract**—In this paper, we propose a novel adaptive voltage control strategy for boost converter via Inverse LQ Servo-Control. Our presented strategy is based on an analytical formula of Inverse Linear Quadratic (ILQ) design method, which is not necessary to solve Riccati's equation directly. The optimal and adaptive controller of the voltage control system is designed. The stability and the robust control are analyzed. Whereas, we can get the analytical solution for the optimal and robust voltage control is achieved through the natural angular velocity within a single parameter and we can change the responses easily via the ILQ control theory. Our method provides effective results as the stable responses and the response times are not drifted even if the condition is changed widely.

**Keywords**—Boost converter, optimal voltage control, inverse LQ design method, type-1 servo-system, adaptive control.

## I. INTRODUCTION

**B**OOST converter should be designed and operated with high voltage ratio, high efficiency and high compactness keeping low cost herewith, the aim issue for researching is in this domain[1]. The control system issues relate to the boost converters, are interested, especially in the concerning topics of discontinuous topologies, nonlinear systems, non-minimum phase systems of the dc to dc converters due to the switched circuit topology[2]. Furthermore, the academic researches are the fashionable issues such as the efficiency, the reliability, the economically and the reduced-size controller. These are the continuous effort to design many control strategies, to improve the performance of the power converters and to consider the number of the control schemes based on diverse tools, have been proposed [3].

Since the classical control methods are designed at one nominal operating point, they could not properly respond to the operating point variations and the load disturbance. Most of them fail to perform satisfactorily under the large parameter or the load variations [4].

The proposed control system strategy is designed based on a linearized small-signal model and employed to control the power converters in which the ILQ design method is an optimal servo-system control without solving Riccati's equation [5]. Using this method, the transfer function can be asymptotically

Sorawit Stapornchaisit is with the Faculty of Engineering, Thai-Nichi Institute of Technology 1771/1 Pattanakarn Rd., Suanluang, Bangkok 10250, Thailand (phone: +66-8-9024-5699; e-mail: sorawit.tni@gmail.com).

Sidshchadhaa Aumted is with the Faculty of Engineering, Thai-Nichi Institute of Technology 1771/1 Pattanakarn Rd., Suanluang, Bangkok 10250, Thailand (e-mail: sidshchadhaa@tni.ac.th).

Hiroshi Takami is with the Department of Electrical Engineering, Faculty of Engineering, Shibaura Institute of Technology 3-7-5 Toyosu, Koto-ku, Tokyo 135-8548, Japan (e-mail: takami@sic.shibaura-it.ac.jp).

designed into specification. Hence, the optimal solution is guaranteed and the optimal gains can be adjusted at workplace [6]-[8]. The ILQ servo-control have characteristic as follow; very easy to designed, stable, robust and can be used as practical servo controller for the optimal electric control [9]-[12].

In this paper, the novel adaptive voltage control strategy via ILQ method is proposed. The paper is organized as follows. In this chapter, describes the advantage of our design method. Chapter II, the modeling, solving and finding of the type-1 ILQ Servo-System for the boost converter are presented. Chapter III, we present the numerical simulations and describe the resulting important properties of this design. Finally, the conclusion and the references are given.

## II. MODEL AND PROPOSE CONTROL STRATEGY

In this step, we adopt the typical boost converter circuit as shown in Fig. 1 via the C-filter within the output circuit; the output voltage is equivalent to voltage source.

### A. Modeling for the Boost Converter Circuit

The boost converter is constituted of the power electronics components as shown in Fig. 1, and the equivalent circuit of boost converter is shown in Fig. 2, where  $v_1$  is the input voltage,  $v_2$  is the output voltage,  $i_1$  is the input current,  $i_2$  is the output current and  $i_c$  is the capacitor currents of the passive low-pass filter, respectively.

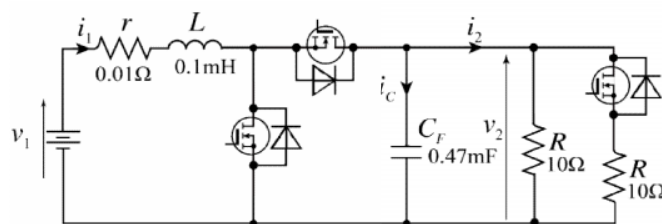

Fig. 1 The boost converter circuit

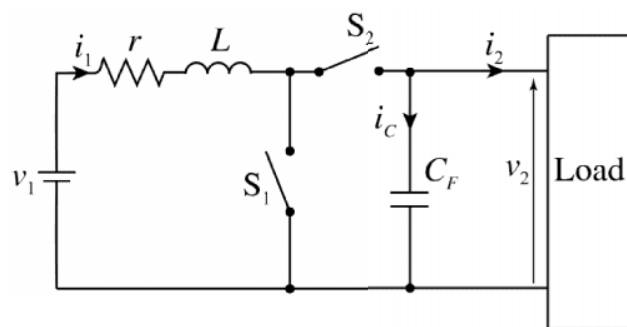

Fig. 2 Equivalent circuit of the boost converter

In this moment, the analytical boost converter is more difficult than the buck converter and the inverter, because the topology of boost converter is changed by switching based on the operation of inductor, MOSFET and diode D.

We can derive a linear state equation of the boost converter into two steps from Fig. 2 to find as follows; 1) deriving state equation, including time-variable duty-factor  $d_f$  into system matrix by state space average method, and 2) deriving time-invariant state equation by small signal analysis method.

### B. Solving the Time-variant Linear State Equation

The time-variant state average space model is consisted of average of a state space equation when the switch  $S_1$  is "ON" period and a state space equation when the switch  $S_1$  is "OFF" period.

Our synthesis of this boost converter based on the time intervals of length  $T_s$ , which is separated into "ON" period and "OFF" period by duty-factor  $d_f$  with the condition of  $0 \leq d_f \leq 1$ .

When the switch  $S_1$  is the close circuit or called "ON" period, the current in the inductor  $L$  increases linearly and the switch  $S_2$  is the open circuit in this period.

During the switch  $S_1$  is the open circuit or called "OFF" period, the stored energy in the inductor  $L$  will be released through closed switch  $S_2$  and the inductor creates the higher output voltage.

- i. The operation of switch can be represented by  $d_f$  to control the output voltage of  $v_2$ .

In the condition of  $0 \leq t \leq d_f T_s$  when the switch  $S_1$  is "ON" period from Fig. 2, the circuit equations are given as follows:

$$v_1 = r i_1 + L \frac{d i_1}{dt}, \quad v_2 = \frac{1}{C_F} \int i_c dt, \quad i_1 = i_2 + i_c. \quad (1)$$

In order to derive the state space equation, we reorganize the equation as follows:

$$\frac{d i_1}{dt} = -\frac{r}{L} i_1 + \frac{1}{L} v_1 \quad (2)$$

$$\frac{d v_2}{dt} = -\frac{1}{C_F} i_2 \quad (3)$$

then we dispose the state space equation as follows:

$$\dot{x} = A_1 x + B_1 u + D_1 d \quad (4)$$

where

$$x = [i_1 \quad v_2]^T, \quad [ \quad ]^T \text{ is transpose matrix, } u = v_1, \quad d = i_2,$$

$$A_1 = \begin{bmatrix} -\frac{r}{L} & 0 \\ 0 & 0 \end{bmatrix}, \quad B_1 = \begin{bmatrix} \frac{1}{L} \\ 0 \end{bmatrix} \text{ and } D_1 = \begin{bmatrix} 0 \\ -\frac{1}{C_F} \end{bmatrix}.$$

- ii. In the condition of when the switch  $S_1$  is "OFF" period from Fig. 2, the circuit equations are given as follows:

$$v_1 = r i_1 + L \frac{d}{dt} i_1 + v_2, \quad v_2 = \frac{1}{C_F} \int i_c dt, \quad i_1 = i_2 + i_c. \quad (5)$$

In order to derive the state space equation, we reorganize the equation as follows:

$$\frac{d}{dt} i_1 = -\frac{r}{L} i_1 - \frac{1}{L} v_2 + \frac{1}{L} v_1 \quad (6)$$

$$\frac{d}{dt} v_2 = \frac{1}{C_F} i_c = \frac{1}{C_F} i_1 - \frac{1}{C_F} i_2 \quad (7)$$

then we dispose the state space equation as follows:

$$\dot{x} = A_2 x + B_2 u + D_2 d \quad (8)$$

where

$$A_2 = \begin{bmatrix} -\frac{r}{L} & -\frac{1}{L} \\ \frac{1}{C_F} & 0 \end{bmatrix}, \quad B_2 = \begin{bmatrix} \frac{1}{L} \\ 0 \end{bmatrix} \text{ and } D_2 = \begin{bmatrix} 0 \\ -\frac{1}{C_F} \end{bmatrix}.$$

Finding the average state space equation indicated by duty-factor  $d_f$  and defining the new state variables as follows:

$$\left. \begin{aligned} A &= d_f A_1 + (1-d_f) A_2 \\ B &= d_f B_1 + (1-d_f) B_2 \\ D &= d_f D_1 + (1-d_f) D_2 \end{aligned} \right\} \quad (9)$$

then considering the time-variant system, the average state equation can be rewritten from (9) as follows:

$$\dot{x} = Ax + Bu + Dd \quad (10)$$

where

$$A = \begin{bmatrix} -\frac{r}{L} & -\frac{1-d_f}{L} \\ \frac{1-d_f}{C_F} & 0 \end{bmatrix}, \quad B = \begin{bmatrix} \frac{1}{L} \\ 0 \end{bmatrix} \text{ and } D = \begin{bmatrix} 0 \\ -\frac{1}{C_F} \end{bmatrix}.$$

### C. Finding the Time-invariant State Equation by Small Signal Analysis Method

According to the time-invariant system, a variable part of the duty-factor is important to separate by applying the superposition of the steady and the variable components for the state equation analysis as follows:

$$d_f = D_f + \Delta d_f \quad (11)$$

where  $D_f$  and  $\Delta d_f$  are the steady and the variable components of duty factor, respectively.

Substituting (11) to (10) yields:

$$A = \begin{bmatrix} -\frac{r}{L} & -\frac{1-(D_f + \Delta d_f)}{L} \\ \frac{1-(D_f + \Delta d_f)}{C_F} & 0 \end{bmatrix} = A + \Gamma \Delta d_f \quad (12)$$

where

$$A = \begin{bmatrix} -\frac{r}{L} & -\frac{1-D_f}{L} \\ \frac{1-D_f}{C_F} & 0 \end{bmatrix}, \Gamma = \begin{bmatrix} 0 & \frac{1}{L} \\ -\frac{1}{C_F} & 0 \end{bmatrix}.$$

Thence, applying the steady state analysis with  $\Delta d_f = 0$ , the steady state equation can be obtained as follows:

$$\dot{x}_0 = Ax_0 + Bu_0 + Dd_0 = 0 \quad (13)$$

where

$x_0 = [I_1 \ V_2]^T$ ,  $u_0 = V_1$ ,  $d_0 = I_2$ .  $I_1$ ,  $I_2$ ,  $V_1$  and  $V_2$  are average values of  $i_1$ ,  $i_2$ ,  $v_1$  and  $v_2$ , respectively.

Then

$$-\frac{r}{L}I_1 - \frac{1-D_f}{L}V_2 + \frac{1}{L}V_1 = 0 \quad (14a)$$

$$I_1 = \frac{1}{1-D_f}I_2. \quad (14b)$$

Substituting (14b) to (14a) and considering  $0 \leq D_f \leq 1$  yield:

$$D_f = 1 - \frac{\frac{V_1}{V_2} + \sqrt{\left(\frac{V_1}{V_2}\right)^2 - 4r\frac{I_2}{V_2}}}{2} \approx 1 - \frac{V_1}{V_2}. \quad (15)$$

Because generally resistance  $r$  is very small, so we can neglect it.

Taking account of  $u = u_0 = V_1 = \text{constant}$  in (10), we consider about state variables as follows:

$$x = x_0 + \Delta x \quad (16a)$$

$$u = u_0 \quad (16b)$$

$$d = d_0 + \Delta d \quad (16c)$$

where  $\Delta x$ ,  $\Delta d$  are variable components as:

$$\Delta x = x - x_0 = \begin{bmatrix} \Delta i_1 \\ \Delta v_2 \end{bmatrix} = \begin{bmatrix} i_1 - I_1 \\ v_2 - V_2 \end{bmatrix}, \Delta d = d - d_0 = \Delta i_2 = i_2 - I_2$$

Substituting (12), (13) and (16a) - (16c) to (10) yields:

$$\Delta \dot{x} = (A + \Gamma \Delta d_f)(x_0 + \Delta x) + Bu_0 + D(d_0 + \Delta d) = \Lambda \Delta x + \Gamma x_0 \Delta d_f + D \Delta d + \Gamma \Delta d_f \Delta x \quad (17)$$

We can assume that  $\Delta d_f \Delta x \approx 0$  on the small signal analysis, thus the time-invariant state equation is given as follows:

$$\dot{x}_s = A_s x_s + B_s u_s + D_s d_s, \quad y_s = C_s x_s \quad (18)$$

where,

$x_s = \Delta x = [\Delta i_1 \ \Delta v_2]^T$ ,  $u_s = \Delta d_f$ ,  $d_s = \Delta d = \Delta i_2$  and

$$A_s = A = \begin{bmatrix} -\frac{r}{L} & -\frac{1-D_f}{L} \\ \frac{1-D_f}{C_F} & 0 \end{bmatrix}, B_s = \Gamma x_0 = \begin{bmatrix} \frac{V_2}{L} \\ \frac{I_1}{C_F} \end{bmatrix},$$

$$C_s = C = [0 \ 1] \text{ and } D_s = D = \begin{bmatrix} 0 & -\frac{1}{C_F} \end{bmatrix}^T$$

Henceforth, the plant must satisfy the controllable and observable system, the minimal-phase system, and the no zeros system at the origin, which already has all of conditions. We can verify and proof the system with the robust control theory approached [5], [6], [13].

#### D. Solving the Type-1 ILQ Optimal Servo-System

In order to design the ILQ optimal servo-system, the following conditions is proposed [4], [8], [14], [15]:

- 1) Proposed strategy extended the state feedback system.
- 2) We can find the analytical optimal solution based on the ILQ design method.
- 3) We can get the asymptotic feature of the ILQ optimal servo-system.
- 4) We can follow the procedure for the optimal solutions of the Type-1 ILQ servo-system.

In this section, we first derive the basic construction for the Type-1 ILQ servo-system, and then we explain about the procedure for getting the optimal gains of the Type-1 ILQ servo-system.

#### E. Finding the Basic Optimal Gains of the Type-1 ILQ Servo-System

Fig. 3 shows a typical servo system, where  $y^*$  is a reference input,  $K_F$  is feedback gain,  $K_I$  represent the integral gains of the servo controller.

Based on the conventional ILQ design method, the set of parameters of the basic ILQ servo-system represented in Fig. 4 are:

$$[K_F \ K_I] = V^{-1} \Sigma V \begin{bmatrix} K_F^0 & K_I^0 \end{bmatrix} \quad (19)$$

where  $K_F^0$  and  $K_I^0$  are the basic optimal gains,  $\Sigma$  is diagonal gain matrix as adjusting parameter, and  $V$  is suitable nonsingular matrix [7], [9], [16].

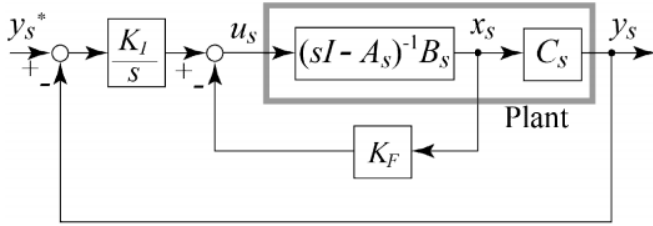

Fig. 3 Block diagram of typical servo-system

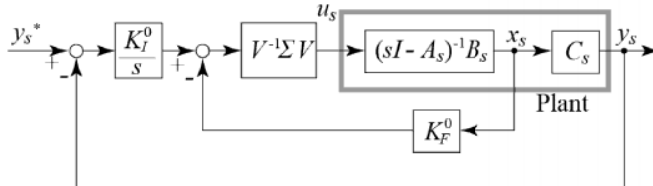

Fig. 4 Block diagram of construction of the ILQ servo-system

At this point we have achieved the optimal solutions of ILQ servo-system with gain  $K_F^0$  and  $K_I^0$ .

*F. Finding the Optimal Condition of the Type-1 ILQ Servo-System and Proposed Adaptive Control Strategy*

The ILQ servo-systems have the special property to converge the closed-loop transfer functions into objective decoupled-transfer functions. This idea leads to very simple adjustment of gains which is easier to control the servo-system. Then, the basic gains  $K_F^0$  and  $K_I^0$  are derived by following procedures:

$$D_c := c_1 A^{d_1-1} B \quad (20)$$

where  $D_c$ , which must be nonsingular, i.e. necessary-and-sufficient condition, enables to decouple the system,  $c_1$  is the 1<sup>st</sup> row-vector of matrix  $C$ , and  $d_1 = \min\{k | c_1 A^{k-1} B \neq 0, k=1,2,\dots\}$  is the order difference between the denominator and the numerator of the plant.

The order difference,  $d_1 = 2$  in the system was given by (20), so that the stable polynomial for  $\phi_1(s)$  determines the response of the servo-system in the condition  $\Sigma \rightarrow \infty$ , can be defined as:

$$\phi_1(s) := \alpha_{1,1} + \alpha_{1,2}s + s^2 \quad (21)$$

where  $\alpha_{1,1}$  and  $\alpha_{1,2}$  are the coefficients of the polynomial, thus the objective transfer function is given by

$$G_1^\infty(s) = \frac{\phi_1(0)}{\phi_1(s)} = \frac{\alpha_{1,1}}{\alpha_{1,1} + \alpha_{1,2}s + s^2} \quad (22)$$

A polynomial matrix can be defined as:

$$N_\phi(A_s) = c_1 \phi_1(A_s) = c_1 (\alpha_{1,1} + \alpha_{1,2}A_s + A_s^2)$$

$$= \begin{bmatrix} \alpha_{1,2}(1-D_f) & (1-D_f)r & \alpha_{1,1} - \frac{(1-D_f)^2}{C_F L} \\ C_F & C_F L & \alpha_{1,1} - \frac{(1-D_f)^2}{C_F L} \end{bmatrix} \quad (23)$$

then we can derive the decoupling gain as follows:

$$K = D_c^{-1} N_\phi(A_s) = \begin{bmatrix} r - \alpha_{1,2}L & \alpha_{1,1}C_F L - (1-D_f)^2 \\ V_2 & (1-D_f)V_2 \end{bmatrix} \quad (24)$$

Consequently we can obtain the optimal basic gains as follows:

$$\begin{bmatrix} K_F^0 & K_I^0 \end{bmatrix} = \begin{bmatrix} K & I \end{bmatrix} \begin{bmatrix} A_s & B_s \\ C_s & 0 \end{bmatrix}^{-1} = \begin{bmatrix} L & \alpha_{1,2}LC_F & \alpha_{1,1}LC_F \\ V_2 & (1-D_f)V_2 & (1-D_f)V_2 \end{bmatrix} \quad (25)$$

In order to achieve a simple design of responses, we give objective transfer function of (22) as:

$$\alpha_{1,1} = \omega_n^2 \quad \text{and} \quad \alpha_{1,2} = 2\zeta\omega_n \quad (26)$$

where  $\omega_n$  is natural angular velocity and  $\zeta$  is damping coefficient.

The sigma can be calculated by following equation:

$$\Sigma > \frac{2(\alpha_{1,2}L - r)}{L} \quad (27)$$

From (25), basic gains  $K_F^0$  and  $K_I^0$ , which are solved by analytical forms, are function of the steady component of duty factor  $D_f$  and voltage  $V_2$ , so that it enables to realize an adaptive control for varying command output voltage  $y_s^*$ . Consequently we can derive a proposed adaptive ILQ servo-system as shown in Fig. 5.

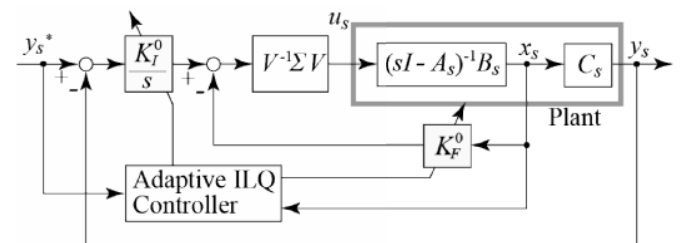

Fig. 5 Block diagram of construction of the proposed adaptive ILQ servo-system (on the basis of (25))

III. NUMERICAL SIMULATIONS AND RESULTS

The parameter of our simulation, which were carried out at the condition of DC input voltage of 12V and the carried frequency of 20 kHz. The result of simulation is as shown in Fig. 6 to Fig. 10. The amplitude of reference voltage through

the low-pass filter, were varied from 24V, 48V and 60V whereas, each reference voltage is increased by 1V or 5V at 0.15s thenceforward, we changed back at 0.2s. Furthermore, for supplying the same disturbance load current, the step-function load of 10Ω, 24Ω, 48Ω and 60Ω is connected to the output terminals at 0.25s, respectively. All of simulation results used the same condition those were  $\omega_n = 500$ ,  $\zeta = 0.707$  and  $\sigma = 1000$ . The blue line represents the reference voltage and the actual voltage is represented by the red line, the output current and duty-factor of system is also presented.

For the evaluating response by the reference input, we define a "rising time", which is an interval from the increasing reference voltage output to 95% of reference voltage. Moreover for the evaluating response by the disturbance of system, we define a "recovery time", which is an interval from the impact of its disturbance to the recovering level.

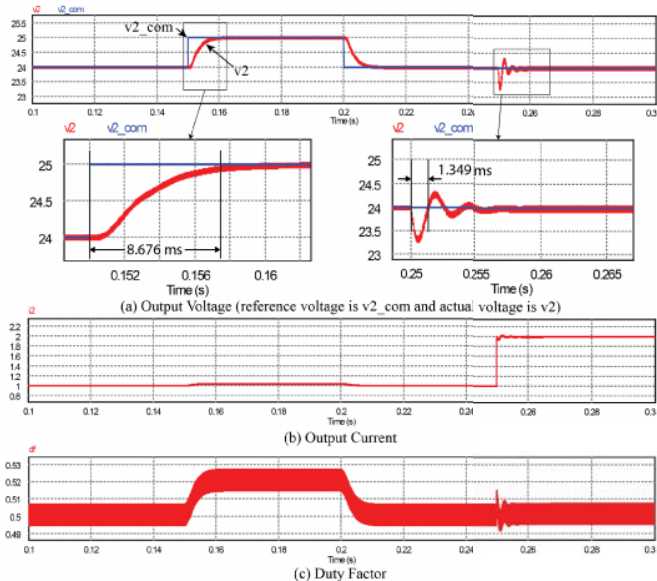

Fig. 6 Type-1 ILQ control with 2<sup>nd</sup>-order  
(Command voltage  $v_2^* = 24V$  to 25V and load = 24Ω)

TABLE I  
RISING TIME AND RECOVERY TIME

	Conditions	Rising Time	Recovery Time
Fig. 6	Type-1 ILQ control with High-order (Command voltage $v_2^* = 24V$ to 25V and load = 24Ω)	8.676ms	1.349ms
Fig. 7	Type-1 ILQ control with High-order (Command voltage $v_2^* = 24V$ to 25V and load = 10Ω)	8.676ms	1.356ms
Fig. 8	Type-1 ILQ control with High-order (Command voltage $v_2^* = 24V$ to 29V and load = 24Ω)	8.676ms	1.349ms

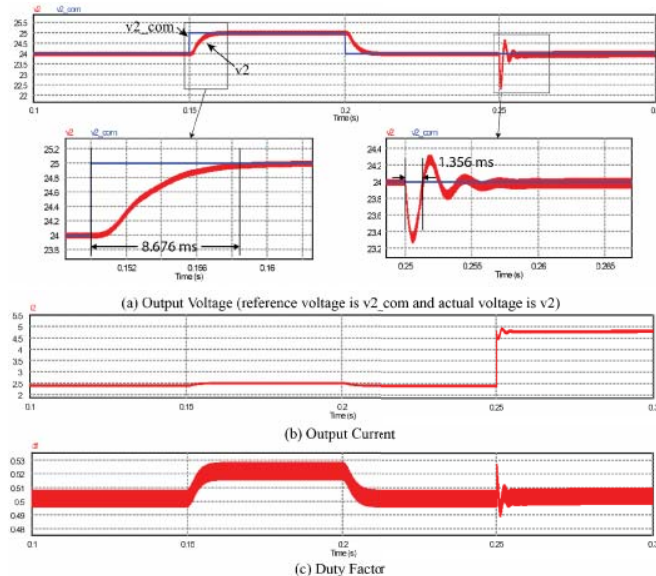

Fig. 7 Type-1 ILQ control with 2<sup>nd</sup>-order  
(Command voltage  $v_2^* = 24V$  to 25V and load = 10Ω)

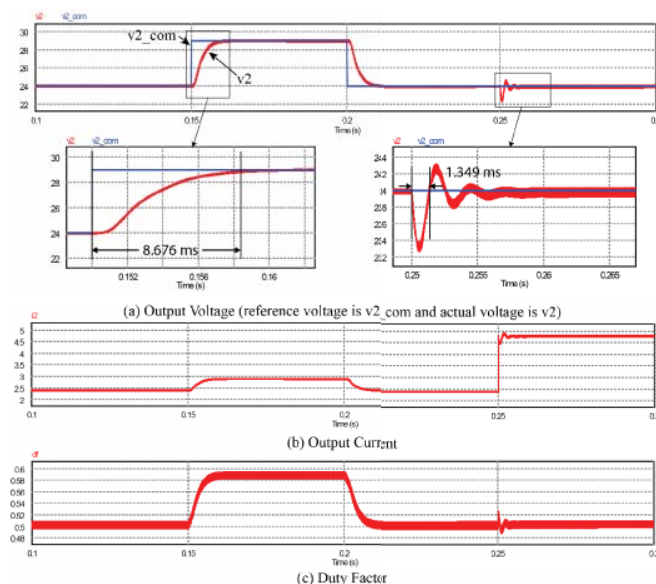

Fig. 8 Type-1 ILQ control with 2<sup>nd</sup>-order  
(Command voltage  $v_2^* = 24V$  to 29V and load = 24Ω)

Considering Fig. 6 and Fig. 7, the rising times of the proposed Type-1 ILQ control with 2<sup>nd</sup>-order are 8.676ms, which mean we can control the rising time with the properties of robust and insensitive of the disturbance of system. By comparing Fig. 6 and Fig. 8, we found that changing the amplitude of the reference voltage from 24V to 25V or 24V to 29V, we can get the rising times are corresponded to 8.676ms, due to adaptive control of  $D_f$  and the reference voltage  $v_2^*$ , which determines the voltage transformation ratio. This means that the optimal gains of our proposed controller are changed automatically and adaptively.

TABLE II  
 RISING TIME AND RECOVERY TIME

	Conditions	Rising Time	Recovery Time
Fig. 6	Type-1 ILQ control with High-order (Command voltage $v_2^* = 24V$ to $25V$ and load = $24\Omega$ )	8.676ms	1.349ms
Fig. 9	Type-1 ILQ control with High-order (Command voltage $v_2^* = 48V$ to $49V$ and load = $48\Omega$ )	7.129ms	2.338ms
Fig. 10	Type-1 ILQ control with High-order (Command voltage $v_2^* = 60V$ to $61V$ and load = $60\Omega$ )	6.230ms	2.703ms

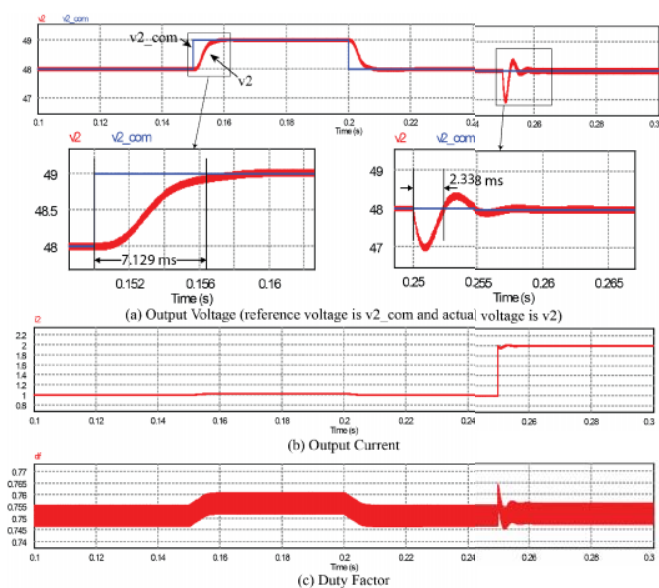

Fig. 9 Type-1 ILQ control with 2<sup>nd</sup>-order (Command voltage  $v_2^* = 48V$  to  $49V$  and load =  $48\Omega$ )

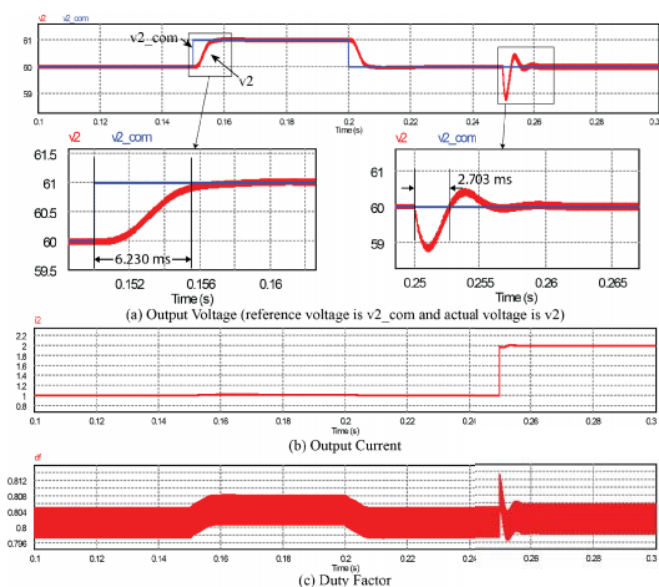

Fig. 10 Type-1 ILQ control with 2<sup>nd</sup>-order (Command voltage  $v_2^* = 60V$  to  $61V$  and load =  $60\Omega$ )

Comparing Fig. 6, Fig. 9 and Fig. 10, all responses are stable, and the command voltage is higher and higher, rising time is smaller and smaller slightly, on the other hand recovery time is larger and larger too. This result of simulation was that excellent adaptive and robust control has been achieved.

In order to observe the disturbance, we designed the simulation condition of the output current  $i_2$  (b) to 1A by defining both the reference voltage and the load resistance as shown in Fig. 6, Fig. 9 and Fig. 10. In this case, we have to evaluate the effect of  $i_2$  to the disturbance of system. The results show that the disturbance is decreased by controlling  $i_2$ .

Considering all results, the duty-factor in (c) is fallen in the controlling region in range of (0,1) are under control.

The rising and recovery times in Fig. 6, Fig. 9 and Fig. 10 are summarized in Table II.

#### IV. CONCLUSION

We have proposed the novel adaptive voltage control strategy for the boost converter by using the type-1 ILQ servo control with the optimal gains of system, which the time response and the disturbance response are controlled by a single parameter,  $\omega_n$ . In case of suppressing disturbance, we should control the output current of  $i_2$  automatically.

#### REFERENCES

- [1] M. Kabalo, B. Blunier, D. Bouquain, A. Miraoui, "State-of-the-art of DC-DC converters for fuel cell vehicles," *Vehicle Power and Propulsion Conference (VPPC), 2010 IEEE*, Sept. 1-3 2010, pp. 1-6.
- [2] G. A. Beccuti, G. Papafotiou and M. Morari, "Optimal Control of the Boost dc-dc Converter," *44th IEEE Conference on Decision and Control 2005 and the European Control Conference 2005, Spain*, Dec. 12-15 2005, pp. 4457-4462.
- [3] D. Cortes, J. Alvarez and Ja. Alvarez, "Robust Control of the Boost Converter," *International Conference on Industrial Electronics and Control Applications*, submitted for publication.
- [4] S. C. Tan, Y. M. Lai, C. K. Tse, and M. K. H. Cheung, "An Adaptive Sliding Mode Controller for Buck Converter in Continuous Conduction Mode," *Nineteenth Annual IEEE Applied Power Electronics Conference and Exposition*, vol. 3, 2004, pp. 1395-1400.
- [5] T. Fujii, "A New Approach to the LQ Design from the Viewpoint of the Inverse Regulator Problem," *IEEE Trans. Automatic Control*, vol. AC-32, no. 11, Nov 1987, pp. 995-1004.
- [6] T. Fujii, Y. Nishimura, S. Shimomura, and S. Kawarabayashi, "A Practical Approach to LQ Design and Its Application to Engine Control," *Proc. IFAC'87, Munich*, 1987, pp. 253-258.
- [7] H. Kimura, T. Fujii, and T. Mori, *Robust Control*. Tokyo: Corona Publishing Co., Ltd, pp. 109-156, 1994.
- [8] H. Takami, "Robust Current Control for Permanent Magnet Synchronous Motors by the Inverse LQ Method -An Evaluation of Control Performance Using Servo-Locks at Low Speed-," *Journal of power Electronics*, vol. 4, no.4, Oct. 2004, pp. 228-236.
- [9] S. Aumted, S. Kanda, H. Takami, and S. Tatsuno, "Optimal Voltage Control for Single-Phase Inverter with Resonant LC Filter by Type-2 ILQ Servo-Control by 2nd-Order Polynomial," *Applied Mechanics and Materials Journal: Trans Tech Publications, Switzerland*, 2013, vol. 622-623, pp. 1514-1518 [*ICMCE 2012 Conf. Shanghai*, Aug. 2012].
- [10] H. Takami, "Optimal Unity Power Factor control of Permanent Magnet Synchronous Motor with q-axis Field by Inverse LQ Method," *ISSN Journal of power Electronics*. Vol. 1, No.2, Oct, 2001, pp. 117-126.
- [11] H Takami, "Design of an optimal servo-controller for current control in a permanent magnet synchronous motor," *Proc. IEE -Control Theory appl.*, vol 149, No. 6 Nov. 2002, pp. 564-572.
- [12] H. Takami and M. Nakagawa, "Optimal Robust Current Control of Three Phase Induction Motor by ILQ Design Method," *Proc. ICEMS 2006 DS2E-07*, 2006.

- [13] T. Fujii, S. Kunimatsu, and O. Kaneko, "Synthesis of ILQ Control System for Disturbance Attenuation," in *Proc. SICE Annual Conference*, Japan, 2008, pp. 1300-1303.
- [14] T. Fujii, and T. Shimomura, "Generalization of ILQ Method for the Design of Optimal Servo Systems," *Trans. of the Institute of Systems, Control and Information Eng.* vol. 1, no. 6, pp.194-203, 1988.
- [15] T. Shimomura, T. Fujii, and N. Suda, "Generalization of the ILQ Regulator Design Method," in *Proc. American Control Conference*, Seattle, 1995, pp. 1967-1968.
- [16] T. Fujii, "Design of Tracking Systems with LQ Optimality and Quadratic Stability," in *Proc. IFAC World Congress, IFAC'93*, Sydney, 1993, pp. 435-442.

**S. Staponchaisit** was born in Bangkok, Thailand, on April 4, 1991. Since 2009, He has been with the Faculty of Engineering (Computer Engineering), Thai-Nichi Institute of Technology, Bangkok Thailand. His present research is concerned with ILQ optimal control system for boost converter

**S. Aumted** was born in Phayao, Thailand, on April 6, 1979. She received the B.Eng. degree in Electrical Engineering from Rajamangala Institute of Technology, Pathum Thani, Thailand and The M.S. degree in Computer Science from Kasetsart University, Bangkok Thailand, in 2001 and 2007, respectively.

From 2007 to 2009, she was a lecturer at Kasetsart University Si Racha Campus with the Department of Computer Science, Faculty of Resource and Environment, Chonburi Thailand. Since 2010, she has been associated with the Faculty of Engineering (Computer Engineering), Thai-Nichi Institute of Technology, Bangkok Thailand, where she has been a lecturer. From December 2011 to June 2012, she was a visiting scholar at Shibaura Institute of Technology, Tokyo Japan, and did research on the optimal voltage control for single-phase inverter with resonant LC filter via type-2 ILQ servo-control by 2nd-order polynomial for six months. She has been active in the fields of wireless communication, embedded system and power electronics. Her present research is concerned with ILQ optimal control system.

Ms. Aumted was a member of Electrical Engineering/Electronics, Computer, Telecommunications and Information Technology Association of Thailand (ECTI Thailand).

**H. Takami** was born in Oita, Japan, on September 21, 1960. He received the B.E. degree in Electrical Engineering from the Kyushu Institute of Technology in 1983 and the M.E. degree in Electrical Engineering from Kyushu University in 1985. From 1985 to 1993, he was with the Department of Electrical Engineering, Yamaguchi University, where he was an Assistant. From 1993 to 2005, he was an Research Associate with the Department of Electrical Engineering, Kyushu University. From 2005 to 2008, he was Associate Professor with the Department of Electrical Engineering, Faculty of Engineering, Shibaura Institute of Technology, Tokyo Japan, and since 2008 he has been a Professor.

He is engaged in the development of the optimal control for power electric systems and motors, renewal energy generation system and smart community project.

Prof. Dr. Takami is a member of the Institute of Electrical Engineers of Japan, the Society of Instrument and Control Engineers of Japan and the Institute of Electrical and Electronic Engineers of USA (IEEE USA).