

Simultaneous Treatment and Catalytic Gasification of Olive Mill Wastewater under Supercritical Conditions

Ekin Kıpçak, Sinan Kutluay, and Mesut Akgün

Abstract—Recently, a growing interest has emerged on the development of new and efficient energy sources, due to the inevitable extinction of the nonrenewable energy reserves. One of these alternative sources which has a great potential and sustainability to meet up the energy demand is biomass energy. This significant energy source can be utilized with various energy conversion technologies, one of which is biomass gasification in supercritical water.

Water, being the most important solvent in nature, has very important characteristics as a reaction solvent under supercritical circumstances. At temperatures above its critical point (374.8°C and 22.1 MPa), water becomes more acidic and its diffusivity increases. Working with water at high temperatures increases the thermal reaction rate, which in consequence leads to a better dissolving of the organic matters and a fast reaction with oxygen. Hence, supercritical water offers a control mechanism depending on solubility, excellent transport properties based on its high diffusion ability and new reaction possibilities for hydrolysis or oxidation.

In this study the gasification of a real biomass, namely olive mill wastewater (OMW), in supercritical water is investigated with the use of Pt/Al₂O₃ and Ni/Al₂O₃ catalysts. OMW is a by-product obtained during olive oil production, which has a complex nature characterized by a high content of organic compounds and polyphenols. These properties impose OMW a significant pollution potential, but at the same time, the high content of organics makes OMW a desirable biomass candidate for energy production.

All of the catalytic gasification experiments were made with five different reaction temperatures (400, 450, 500, 550 and 600°C), under a constant pressure of 25 MPa. For the experiments conducted with Ni/Al₂O₃ catalyst, the effect of five reaction times (30, 60, 90, 120 and 150 s) was investigated. However, procuring that similar gasification efficiencies could be obtained at shorter times, the experiments were made by using different reaction times (10, 15, 20, 25 and 30 s) for the case of Pt/Al₂O₃ catalyst. Through these experiments, the effects of temperature, time and catalyst type on the gasification yields and treatment efficiencies were investigated.

Keywords—Catalyst, Gasification, Olive mill wastewater, Supercritical water.

Ekin Kıpçak is with Yildiz Technical University, Department of Chemical Engineering, Davutpasa Campus, 34210 Esenler, Istanbul, Turkey (phone: 0090-212-3834781; fax: 0090-212-3834725; e-mail: eyildir@yildiz.edu.tr / ekinyildirim@hotmail.com).

Sinan Kutluay is with Yildiz Technical University, Department of Chemical Engineering, Davutpasa Campus, 34210 Esenler, Istanbul, Turkey (e-mail: sinan_kutlu04@hotmail.com).

Mesut Akgün is with Yildiz Technical University, Department of Chemical Engineering, Davutpasa Campus, 34210 Esenler, Istanbul, Turkey (e-mail: akgunm@yildiz.edu.tr).

I. INTRODUCTION

SUPERCritical water gasification (SCWG) has recently received much attention as a potential alternative to energy conversion methods applied to aqueous/non-aqueous biomass sources [1-3] or fossil fuels such as coal [4, 5], due to the unique physical properties of water above its critical conditions (374.8°C and 22.1 MPa). At supercritical conditions, water behaves both as an acidic and alkaline precursor for acidic or basic reactions on account of the higher concentrations of H₃O⁺ and OH⁻ ions. This is due to the fact that the ionic product of subcritical and supercritical water at high pressures is some orders of magnitude greater than that of ambient water [6-8]. Therefore, supercritical water is considered both as a solvent for organic materials and as a reactant at processes such as the oxidative treatment of wastewaters, the gasification of aqueous organic solutions and the production of fine metal oxide particles. Since organic compounds have complete miscibility and a high solubility in supercritical water, chemical reactions with high efficiencies and without interfacial transport limitations can be obtained in the case of water-organic mixtures. Therefore, supercritical water offers a control mechanism depending on solubility, excellent transport properties based on its high diffusion ability, a low viscosity and new reaction alternatives for hydrolysis or oxidation [1, 9].

Energy production based on fossil fuels causes high import expenditures, environmental problems and a major consumption of the world's nonrenewable energy reserves. Hence, a growing interest has emerged on the development of new and efficient energy sources. Biomass energy is among these sources, which can be utilized with various energy conversion technologies. One of these technologies is biomass gasification in supercritical water that has many advantages, such as high gasification efficiency and considerable amounts of flammable component production in the gaseous effluent during the process. Extensive investigations have been conducted in the recent years on this topic, which included model compounds such as glucose, cellulose, lignin and some real biomass compounds [1, 3, 10, 11].

In this study, the catalytic gasification of a real biomass, olive mill wastewater, was investigated. OMW is a by-product obtained during olive oil production, which is a fundamental economic activity for countries along the Mediterranean coast. OMW is generally composed of the water content of the olive

fruit, water used to wash and process the olives, soft tissues from the olive pulp and a very stable oil emulsion [12]. The annual OMW production in the Mediterranean countries is estimated to range from 10 to 30 million m³. This quantitative diversity results from different factors such as the oil extraction method, cultivation soil, the use of pesticides and fertilizers, olive harvesting time, degree of ripening, duration of aging, olive variety and climatic conditions [13]. The typical OMW composition by weight is 83-96% water, 3.5-15% organic compounds and 0.5-2% mineral salts. The organic fraction includes sugars, tannins, pectins, lipids, organic acids, nitrogen compounds, polyalcohols and polyphenols. The complex composition stated above makes OMW a significant pollution potential. Its polyphenol content is responsible for several biological effects, as phenolic compounds of low molecular weight show toxicity on seed germination, aquatic organisms and bacteria. But at the same time, the high content of organics makes OMW a desirable biomass candidate for energy production.

The gasification experiments were made with two different catalysts, Ni/Al₂O₃ and Pt/Al₂O₃. Considering Ni/Al₂O₃, the experiments were conducted at five reaction temperatures (400, 450, 500, 550 and 600°C), with five reaction times (30, 60, 90, 120 and 150 s) under a constant pressure of 25 MPa. On the other hand, for Pt/Al₂O₃, the experiments were performed at the same reaction temperature interval and pressure, but five different reaction times (10, 15, 20, 25 and 30 s) were chosen, procuring similar gasification efficiencies could be obtained at shorter times. With the aid of these experiments, it was aimed to find the effect of reaction temperature, reaction time and catalyst type on the gasification yield, biofuel composition and treatment efficiency. The results demonstrate that catalytic gasification of OMW under supercritical conditions can be employed both as a treatment process and as a way of energy recovery, in very short time intervals.

II. MATERIALS AND METHODS

A. Materials

The olive mill wastewater used in the experiments was supplied from an olive oil producing plant in Turkey, which was roughly filtered and diluted with distilled water in order to obtain the desired Total Organic Carbon (TOC) amounts. The characteristics of the OMW used in this work are presented in Table I.

B. Catalysts

The Pt/Al₂O₃ catalyst was obtained from Hach-Lange, which contains 2.95% (wt.) oxygen, 55.86% (wt.) aluminum and 41.19% (wt.) platinum. From the SEM images of the catalyst shown below in Fig. 1, it can be seen that Pt/Al₂O₃ particles have a spherical and a porous shape.

On the other hand the SEM images of the Ni/Al₂O₃ catalyst, which was also obtained from Hach-Lange, are shown in Fig. 2. From the analysis, it was found that the catalyst contained

9.30% (wt.) aluminum, 8.54% (wt.) calcium and 82.16% (wt.) nickel.

TABLE I
THE CHARACTERISTICS OF THE OMW

Parameters	Value
pH	4.36
Total Organic Carbon (mg/L)	6138
Inorganic Carbon (mg/L)	30.1
Total Nitrogen (mg/L)	99.0
Total Solid Matter (g/L OMW)	10.347
Ash (g/L OMW)	2.877
Phenols (g/L OMW)	3.695
Ca (g/L OMW)	86.8
Na (g/L OMW)	0.7713
K (g/L OMW)	452.2
Mg (g/L OMW)	14.21
Na (g/L OMW)	22.27

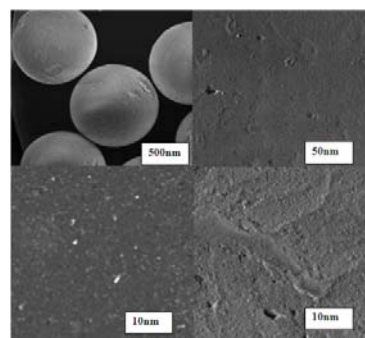

Fig. 1 SEM images of the Pt/Al₂O₃ catalyst

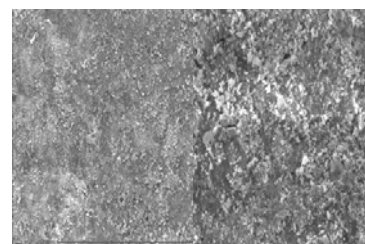

Fig. 2 SEM images of the Ni/Al₂O₃ catalyst

C. Experimental Setup

The catalytic gasification experiments were performed in the reactor system with a volume of 8.305 mL, which is placed into a PID controlled split furnace (Protherm, model SPT 11/70/750). From the feed pump to the gas-liquid separator, all of the wetted parts of the system, such as tubing, fittings, etc., were made of 316 SS. The OMW solution is pumped into the furnace using a high pressure pump (Autoclave Engineers, Series III pump). After exiting the furnace, the effluent is cooled rapidly by passing through a heat exchanger, and the reaction immediately stops. The possible solid particles in the effluent, which would be formed, are removed with a 0.5 μm inline filter before the stream is depressurized by a back-pressure regulator (BPR)

(GO Regulator Inc.). The system pressure is kept at a constant value (± 0.1 MPa) by the BPR set at the exit of the reactor and monitored through a digital pressure indicator. The system temperature is also kept stable ($\pm 1^\circ\text{C}$) through the PID-controlled split furnace. The products leaving the BPR are separated by a gas-liquid separator. The gaseous effluent taken from the top portion of the separator is transported for quantitative analysis by a gas chromatograph capable of online sampling. On the other hand, the samples taken from the liquid effluent leaving the system are sent for TOC analysis. The experimental setup is schematically demonstrated in Fig. 3.

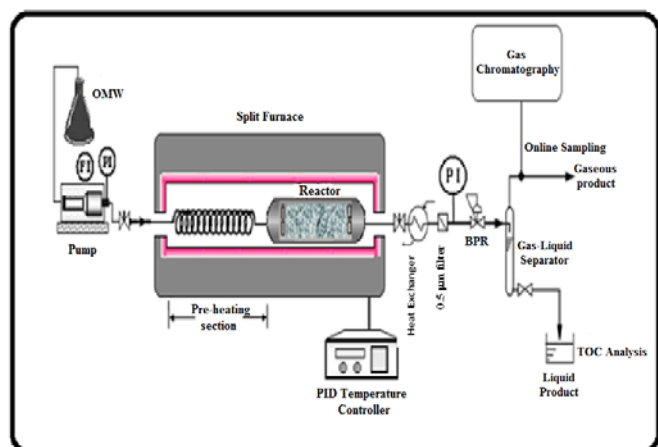

Fig. 3 Schematic demonstration of the experimental setup

D. Liquid Product Analysis

The liquid samples taken from the bottom of the gas-liquid separator were characterized for determining their treatment efficiencies by their TOC concentrations. TOC analyses were performed by a total organic carbon – total nitrogen analyzer (Hach-Lange IL550 TOC-TN), which is based on the combustion catalytic oxidation method, using a highly sensitive multi-channel, non-dispersive infrared detector (NDIR).

E. Gaseous Product Analysis

The gaseous product obtained from the top portion of the gas-liquid separator is taken to a gas chromatograph for quantitative analysis. The instrument used for this aim was a Perkin Elmer Arnel brand, Clarus 500 model gas chromatography device, coupled with one FID and two TCD detectors.

F. Other Analyses

The total phenolic content of the OMW was determined using the Folin-Ciocalteu method. Physicochemical properties of the wastewater such as total solids and ash in Table I were determined according to the Standard Methods.

III. RESULTS AND DISCUSSION

A. Experiments Performed with Ni/Al₂O₃ Catalyst

The experiments with Ni/Al₂O₃ catalyst were made under a constant pressure of 25 MPa, and it was aimed to investigate the effect of five different temperatures (400, 450, 500, 550 and 600°C) and five different reaction times (30, 60, 90, 120 and 150 s) on the gasification yield, flammable component content and treatment efficiency of the wastewater.

As a result of the experiments, it was seen that gaseous effluent flow rates up to 25 mL/min could be obtained by the catalytic gasification of OMW. However, the sole interpretation of this can be quite misleading, as the OMW flow rates fed to the reactor were calculated considering the water density at supercritical conditions, in order to keep the reaction times constant. In other words, the OMW feed flow rates are greater at lower temperatures. Hence, it is more convenient to evaluate the gaseous effluent amounts with respect to the unit amount of OMW fed to the system; i.e. the gas product yields (Fig. 4). As it can be seen from the figure, the gas product yield increased considerably with temperature, and began to decrease after 550°C. At 550°C and 150 s, a maximum yield of 9.43 mL/mL OMW was obtained.

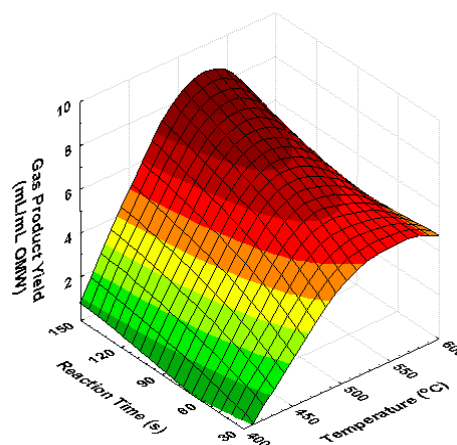

Fig. 4 The change of gas product yield with temperature and reaction time, for Ni/Al₂O₃ catalyst

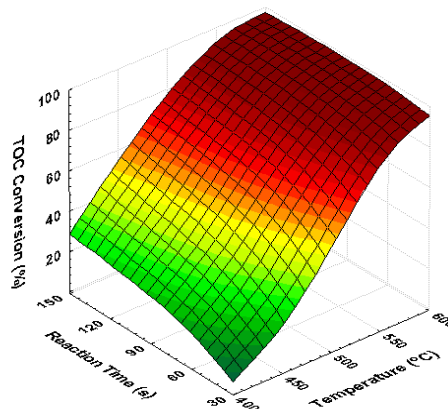

Fig. 5 The change of TOC conversion with temperature and reaction time, for Ni/Al₂O₃ catalyst

Fig. 5 shows the change of TOC conversion of the liquid effluent with temperature and time. Accordingly, it can be seen that TOC conversion increased with temperature and reaction time. This is an expected occasion, as the organic content of OMW reacted more and got through the gaseous phase, as the reaction temperature and duration increased. At elevated temperatures and reaction times, more than 97% of the organic carbon present in OMW was transferred into the gaseous phase.

The gaseous effluents were mainly composed of hydrogen, carbon dioxide and C₁-C₄ hydrocarbons, such as methane, ethane, propane and propylene. Besides these products, scarce amounts of O₂, N₂, n-Butane, i-Butane, 1-Butene, iso-Butene, T-2-Butene, C-2-Butene and 1,3-Butadiene were also obtained. Fig. 6 and Fig. 7 show the change of the two main gaseous products, methane and hydrogen at different reaction conditions, respectively.

Accordingly, the methane amount showed an increasing tendency with temperature and reaction time. The maximum amount of methane (26%) was obtained in the experiment performed at 600°C and 150 s. On the contrary, unlike methane, hydrogen showed a decreasing tendency with temperature. The maximum amount of hydrogen, which was about 13%, was obtained at 400°C and 150 s. But hydrogen did not show major deviations neither with temperature, nor with reaction time.

The change in the total biofuel content of the gaseous effluent with respect to reaction temperature and time is given in Fig. 8. Considering the maximum amount of the biofuel content in the gaseous effluent, it was seen that about 42% of the produced gas was composed of flammable components, which was obtained at 550°C for a reaction time of 30 s. At these conditions, a gas product yield of 4.95 mL/mL OMW fed to the reactor was observed.

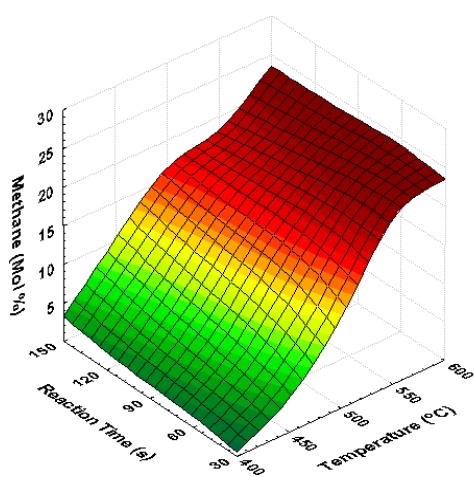

Fig. 6 The change of methane content with temperature and reaction time, for Ni/Al₂O₃ catalyst

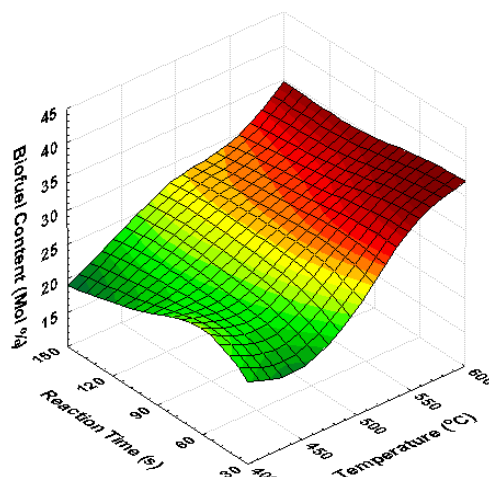

Fig. 8 The change of total biofuel content with temperature and reaction time, for Ni/Al₂O₃ catalyst

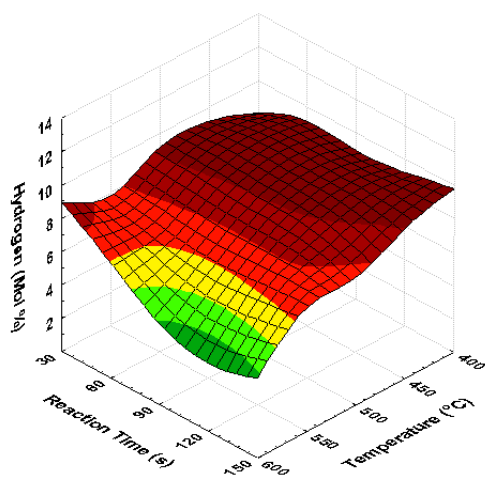

Fig. 7 The change of hydrogen content with temperature and reaction time, for Ni/Al₂O₃ catalyst

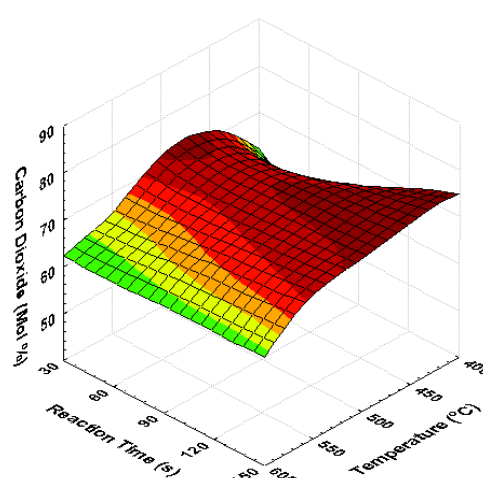

Fig. 9 The change of carbon dioxide content with temperature and reaction time, for Ni/Al₂O₃ catalyst

Fig. 9 shows the change of carbon dioxide content of the gaseous effluent with respect to temperature and time. Accordingly, it showed a slightly increasing trend with decreasing temperatures. The maximum amount of carbon dioxide, which was about 82%, was obtained at 450°C and for a reaction time of 90 s.

B. Experiments Performed with Pt/Al₂O₃ Catalyst

Seeing that high gasification and treatment efficiencies could be obtained for Ni/Al₂O₃ catalyst at very short reaction times like 30 s, it was decided to investigate the effect of even shorter reaction times for the case of Pt/Al₂O₃ catalyst. The experiments with were made under the same constant pressure of 25 MPa, and a similar reaction temperature interval was used (400, 450, 500, 550 and 600°C). But this time 10, 15, 20, 25 and 30 s were chosen as the reaction times.

Fig. 10 shows the change of gas product yield with temperature and time. As it can be seen from the figure, gas product yields ranging between 2.3 to 13.3 mL/mL OMW were observed. Amount of gaseous effluent increased considerably with temperature, and a maximum yield of 13.3 mL/mL OMW was obtained at 600°C, 10 s. This value was higher than that obtained for Ni/Al₂O₃ catalyst, which was 9.43 mL/mL OMW.

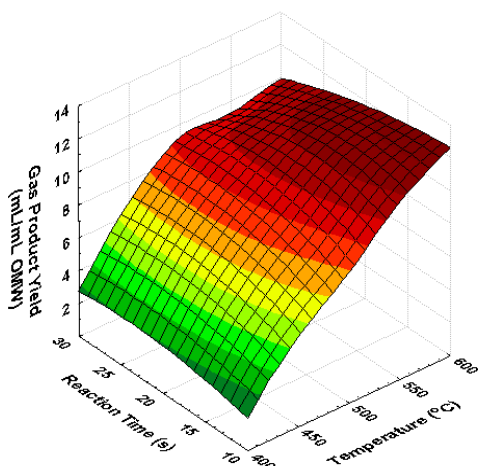

Fig. 10 The change of gas product yield with temperature and reaction time, for Pt/Al₂O₃ catalyst

Fig. 11 shows the treatment efficiency of OMW in terms of its TOC conversion. Just like the results obtained for Ni/Al₂O₃ catalyst, TOC conversion showed an increasing tendency with reaction temperature and time. At 600°C and 30 s, about 95% of the organics present in OMW was transformed to the gaseous phase, which was again mainly composed of hydrogen, carbon dioxide and C₁-C₄ hydrocarbons.

Figs. 12 and 13 show the change methane and hydrogen contents at different reaction conditions, respectively. Accordingly, the methane amount showed an increasing tendency with temperature. At low temperatures it increased with time, whereas at high temperatures, the opposite was observed. This shows the degradation of the formed methane

to the final reaction products like carbon dioxide and water at elevated temperatures. The maximum amount of methane was observed to be 38%, at 600°C and 25 s.

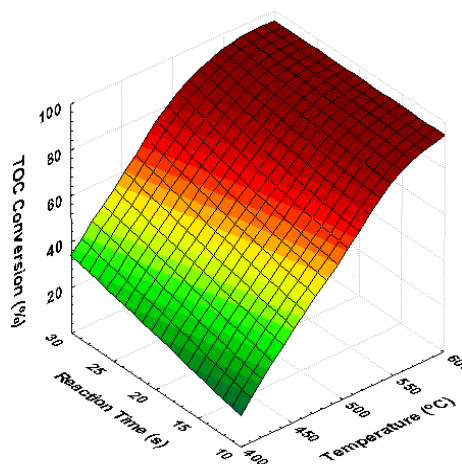

Fig. 11 The change of TOC conversion with temperature and reaction time, for Pt/Al₂O₃ catalyst

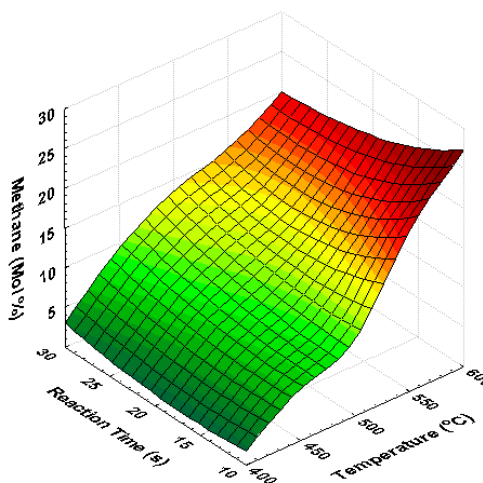

Fig. 12 The change of methane content with temperature and reaction time, for Pt/Al₂O₃ catalyst

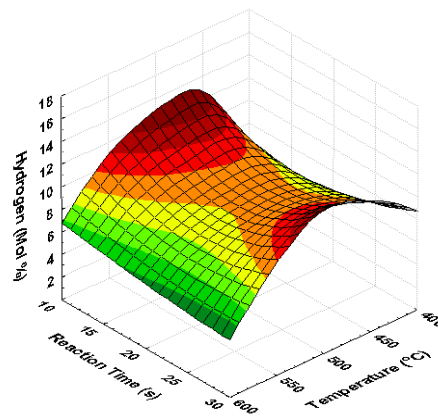

Fig. 13 The change of hydrogen content with temperature and reaction time, for Pt/Al₂O₃ catalyst

Hydrogen showed an increasing and then decreasing tendency with reaction temperature. The maximum amount of hydrogen, which was about 16%, was obtained at 450°C and 10 s. Just like the experiments performed with Ni/Al₂O₃ catalyst, hydrogen did not show major deviations with reaction time.

The change in the total biofuel content of the gaseous effluent with respect to reaction temperature and time is given in Fig. 14. Considering the maximum amount of the biofuel content in the gaseous effluent, it was seen that about 54% of the produced gas was composed of flammable components, which was obtained at 600°C for a reaction time of 25 s. This value is higher than that obtained for Ni/Al₂O₃ catalyst.

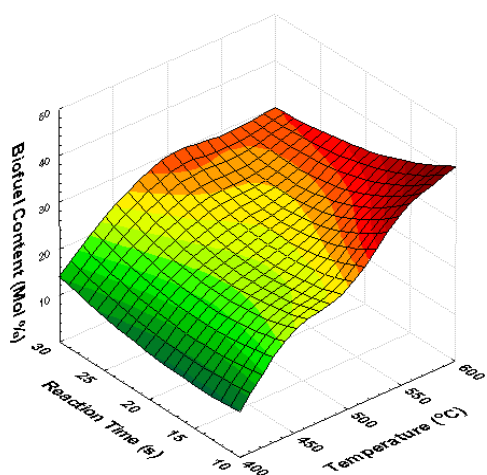

Fig. 14 The change of total biofuel content with temperature and reaction time, for Pt/Al₂O₃ catalyst

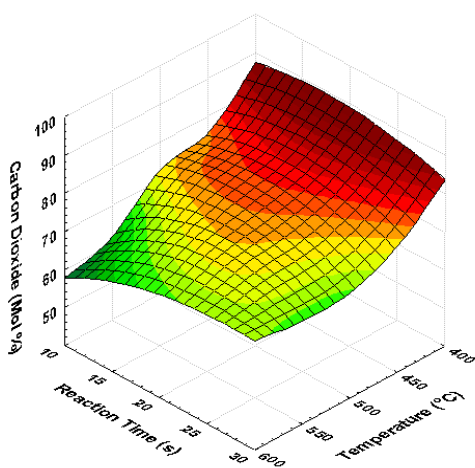

Fig. 15 The change of carbon dioxide content with temperature and reaction time, for Pt/Al₂O₃ catalyst

Fig. 15 shows the change of carbon dioxide content of the gaseous effluent with respect to temperature and time. Accordingly, it showed a slightly increasing trend with decreasing temperature. At low reaction temperatures, the amount of carbon dioxide increased with decreasing time, whereas at high reaction temperatures, the opposite was

observed. The maximum amount of carbon dioxide, which was about 92%, was obtained at 400°C and for a reaction time of 15 s.

IV. CONCLUSION

The experimental results regarding the gasification OMW with the use of Ni/Al₂O₃ and Pt/Al₂O₃ catalysts show that the process can be employed both as a treatment process and as a way of energy recovery, in very short reaction times. The gaseous products were mainly composed of hydrogen, carbon dioxide and C₁-C₄ hydrocarbons. Gas product yields up to 13.3 mL/mL OMW for Pt/Al₂O₃ catalyst, and 9.4 mL/mL OMW for Ni/Al₂O₃ catalyst were obtained. What is more, at high temperatures and reaction times, treatment efficiencies greater than 95% were obtained for both catalysts.

ACKNOWLEDGEMENT

This work has been supported by The Scientific and Technological Research Council of Turkey (TUBITAK, Project no: 108M546).

REFERENCES

- [1] E. Kıpçak, O. O. Söğüt, and M. Akgün, "Hydrothermal gasification of olive mill wastewater as a biomass source in supercritical water", *Journal of Supercritical Fluids*, Vol. 57, pp. 50-57, 2011.
- [2] J. Yanik, E. Ebale, A. Kruse, M. Saglam, and M. Yuksel, "Biomass gasification in supercritical water: Part 1. Effect of the nature of the biomass", *Fuel*, Vol. 86, pp. 2410-2415, 2007.
- [3] P. D'Jesus, N. Boukis, B. Kraushaar-Czarnetzki, and E. Dinjus, "Gasification of corn and clover grass in supercritical water", *Fuel*, Vol. 85, pp. 1032-1038, 2006.
- [4] S. Wang, Y. Guo, L. Wang, Y. Wang, D. Xu, and H. Ma, "Supercritical water oxidation of coal: Investigation of operating parameters' effects, reaction kinetics and mechanism", *Fuel Proc. Tech.*, Vol. 92, pp. 291-297, 2011.
- [5] A.A. Vostrikov, O.N. Fedyaeva, D.Y. Dubov, S.A. Psarov, and M.Y. Sokol, "Conversion of brown coal in supercritical water without and with addition of oxygen at continuous supply of coal-water slurry", *Energy*, Vol. 36, pp. 1948-1955, 2011.
- [6] N. Akiya and P. E. Savage, "Roles of water for chemical reactions in high-temperature water", *Chem. Rev.* Vol. 102, pp. 2725-2750, 2002.
- [7] G. Brunner, "Near critical and supercritical water. Part I. Hydrolytic and hydrothermal processes", *J. Supercrit. Fluids*, Vol. 47, pp. 373-381, 2009.
- [8] A. Kruse, and E. Dinjus, "Hot compressed water as reaction medium and reactant: 2. Degradation reactions", *J. Supercrit. Fluids*, Vol. 41, pp. 361-379, 2007.
- [9] H. Erkonak, O. O. Söğüt, and M. Akgün, "Treatment of olive mill wastewater by supercritical water oxidation", *J. Supercrit. Fluids*, Vol. 46, pp. 142-148, 2008.
- [10] D. Klingler and H. Vogel, "Influence of process parameters on the oxidative decomposition and oxidation of glucose in sub- and supercritical water", *J. Supercrit. Fluids*, Vol. 55, pp. 259-270, 2010.
- [11] P. T. Williams and J. Onwudili, "Subcritical and supercritical water gasification of cellulose, starch, glucose, and biomass waste", *Energy & Fuels*, Vol. 20, pp. 1259-1265, 2006.
- [12] F. Raposo, R. Borja, E. Sanchez, M. A. Martin, and A. Martin, "Performance and kinetic evaluation of the anaerobic digestion of two-phase olive mill effluents in reactors with suspended immobilized biomass", *Water Research*, Vol. 38, pp. 2017-2026, 2004.
- [13] R. Borja, B. Rincon, and F. Raposo, "Review: Anaerobic biodegradation of two-phase olive mill solid wastes and liquid effluents: kinetic studies and process performance", *J Chem Technol Biotechnol*, Vol. 81, pp. 1450-1462, 2006.