

Optical Wireless Sensor Networks Based on VLC with PLC-Ethernet Interface

Heejin Lee, Yeonjoo Kim, Kyungrak Sohn

Abstract—We present a white LED-based optical wireless communication systems for indoor ubiquitous sensor networks. Each sensor node could access to the server through the PLC (Power Line Communication)-Ethernet interface. The proposed system offers a full-duplex wireless link by using different wavelengths to reduce the inter-symbol interference between uplink and downlink. Through the 1-to-n optical wireless sensor network and PLC modem, the mobile terminals send a temperature data to server. The data transmission speed and distance are 115.2kbps and about 60cm, respectively.

Keywords—Visible light communications, LED lighting, power line communications, ubiquitous sensor networks, full-duplex links

I. INTRODUCTION

THE rapid development of semiconductor material technology for LEDs in the visible spectrum has given rise to better alternatives for future lighting technologies particularly white LED (WLED) [1]. The superiority of LEDs over incandescent lights is well known. They are used in displays, signal devices, and other applications that require illumination. One important characteristic of LEDs is that they are semiconductor devices, and hence, they can be easily modulated for communications. Therefore, there exists a possibility of incorporating LED-based wireless communication systems into these illumination devices. Its potential advantage is that it has a large bandwidth that is not restricted by regulations or license fees. Simple LEDs used in indoor lighting can be employed to study the transmission rate for a short range under the influence of noise sources. These LEDs can provide cable-free communication at bit rates as high as several tens of megabit per second between the LED devices and mobile terminals [2]. However, it is difficult for existing buildings and structures such as ships and vehicles to install communication cables on their ceilings or floors. One research group suggested that the existing power lines are a good option for use in optical communications [3-4]. Power-line communications (PLCs) make it possible to use ubiquitous electricity power lines installed in a house. All terminals connected to the power line can be transfer the data to the Ethernet network through the PLC modems.

In this paper, we propose a ubiquitous VLC systems integrated to the PLC-Ethernet networks [5-6]. Some sensor readings on the wireless sensor nodes transmit to the LED lighting on the ceiling and then retransmitted to the monitoring systems through the PLC and Ethernet network.

Heejin Lee is with Korea Maritime University, Korea (e-mails:globalhjlee@gmail.com, krsohn@hhu.ac.kr)

II. PRINCIPLE OF SYSTEM

Fig. 1 shows a schematic of optical wireless sensor networks based on a VLC with PLC-Ethernet interface.

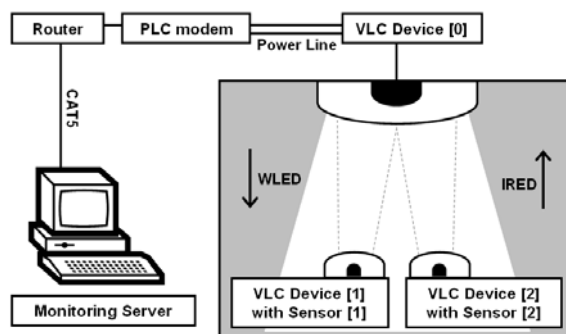

Fig. 1 Schematic of optical wireless sensor networks based on VLC

The system consists of one non-directed optical access point with a WLED array transmitter and a Si-based PD (photodiode) receiver. The inter-symbol interference between an uplink and a down link was solved by using a different wavelength. Infrared LED for uplink and white LED for downlink were chosen. Fig. 2 (a) shows a system block diagram of the downlink as referred in Fig. 1. First, if the server wants to receive sensor data from the Ethernet-to-serial (E/S) converter with an allocated IP address, the router sends a request command to E/S converter via the PLC modems and the power-line.

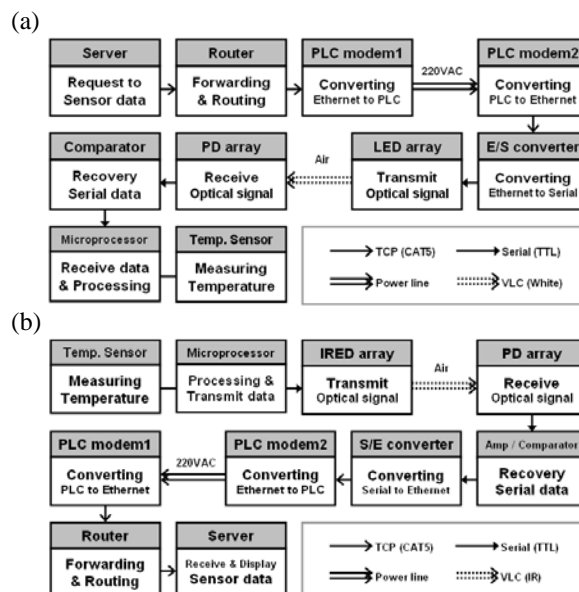

Fig. 2 System block diagram: (a) Down-link (Server to Device 1 and 2) and (b) Up-link (Device 1 and 2 to Server)

The E/S converter changes Ethernet signal to TTL level. The electrical signals are converted to the optical signals at the LED lighting, which is composed of 54 LEDs and LED driver. In the opposite, the PD detects the optical signal and convert to the electrical one. After amplifying, it recovers to the TTL signal completely by the comparator. Microprocessor reads the signal and checks the request ID. After that, current temperature is updated to the server. System block diagram for up-link (Device1 and 2 to Server) is shown in Fig. 2(b). The up-link is activated when mobile nodes received a request signal from the server. Response signals are consisted of the temperature data and the device ID of Device 1 and 2. The signal is transmitted to Device 0 by IRED modules. The signal received at IR-filtered PD is boosted by an electrical amplifier because the signal level is very low. The voltage level is recovered to TTL completely by a comparator. TTL signal is converted to Ethernet signal by S/E (serial-to-Ethernet) converter. Finally, current temperature data is arrived at the server via the PLC modems, power-line and router.

III. FABRICATION AND EXPERIMENTAL SETUP

Figure 3 shows an access pointer referred to VLC Device0. It is used for forwarding some data in down-link and up-link. Section A is a PLC modem2 running in 10Mbps under the full-duplex mode. Section B is an Ethernet-to-serial and a serial-to-Ethernet converter which is controlled by a microprocessor. Section C is a 74LS04 as an inverter for driving WLEDs. The signal from the PLC were inverted by NOT gate and then applied to the LED circuit because they were still ON when no signal was presented to the lightings [7]. Section D is an LM2901n as a comparator for a signal recovery. Section E is an LM386 as an amplifier. Section F is DC power module.

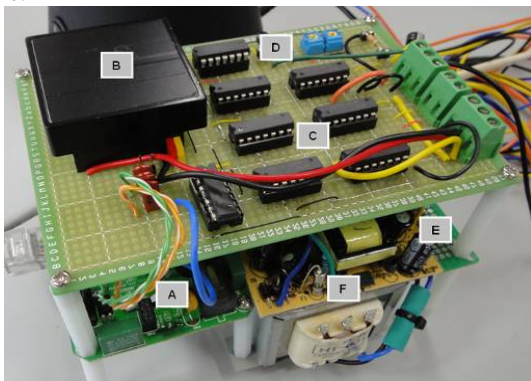

Fig. 3 Photograph of VLC Device 0

Fig. 4 shows LED lighting composed of 54 WLEDs and 7 PDs [8], [9]. For the convenience of experimental setup, a commercial product was used. Several LEDs located in the center were replaced to the PDs in order to realize the bidirectional access. Section G is WLEDs for illumination and data communication. Section H is PDs (SHF213-FA, OSRAM) for receiving data from IREDS.



Fig. 4 Photograph of optical transceiver at access point

Fig. 5 shows a developed mobile terminal referred to VLC Device1 and 2 with IREDS and PDs. Section A is a temperature sensor with an analog voltage output. Section B is an atmega128 (Atmel®) for signal processing. Section C is a 74LS04 inverter for driving IREDS. Section D is an LM2901n as a comparator for signal recovery. The comparator clips the amplified signal to a range of 0-5 V, hence making it TTL. Section E is batteries for supplying DC power.

Fig. 6 shows an optical part of the mobile terminals composed of 2 IREDS and a PD, which have a concentrator. Section F is an IRED (EL-1KL3, KODENSHI) for the optical transmitting. Section G is a PD module with a filter [8].

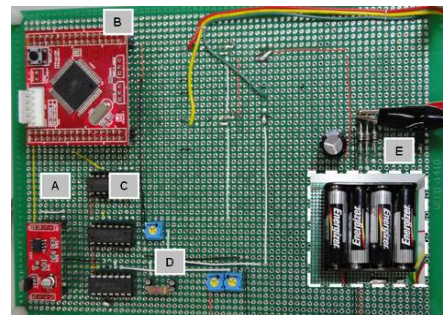

Fig. 5 Photograph of VLC Device1 as a mobile terminal



Fig. 6 Photograph of optical transceiver connected to mobile terminal

Fig. 7 shows an experimental setup for PLC-Ethernet based full-duplex communications. The communication distance is 60 cm. The power of Device1 and 2 provided by DC power supply instead of batteries. The temperature of the experiment

room was about 25 °C with about 170lux fluorescent light as general office. The transmitted data is an array of random text characters.

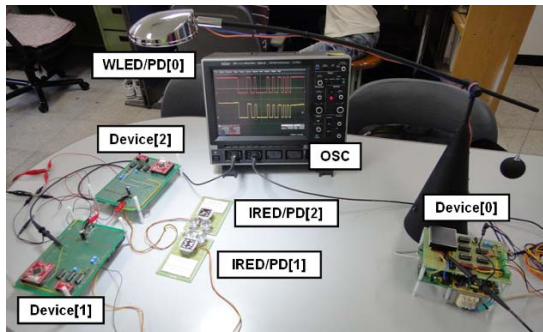

Fig. 7 Experimental setup for optical wireless sensor network

IV. EXPERIMENTAL RESULTS AND DISCUSSION

The system performance of a downlink was examined with changing the bit-rate of serial communication from 9.6 to 115.2 kbps. The result of VLC-transmission test at 9.6 kbps is shown in Fig. 8(a). It shows that there was no trouble in the temporal response at 9.6 kbps. With increase the bit-rate, we could not find any trouble and signal distortion. Fig. 8(b) shows the result of VLC-transmission test at 115.2 kbps. It also shows clear transmission characteristics without distortion.

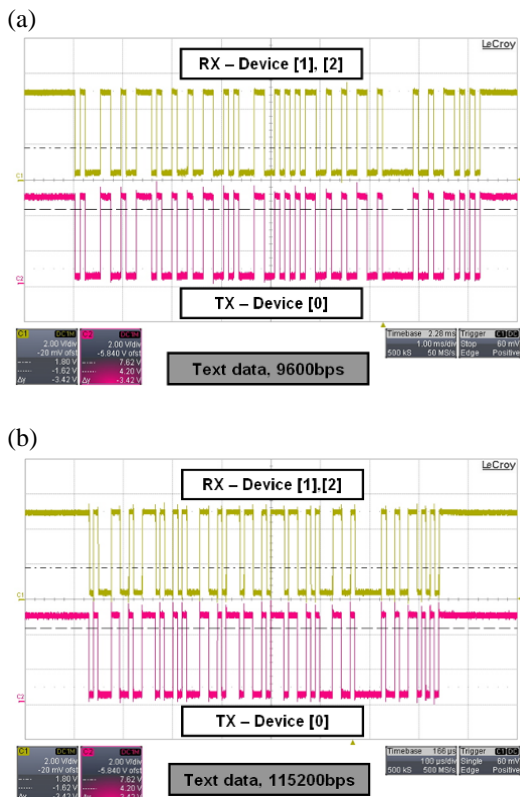

Fig. 8 Performance of downlink transmission:
 (a) 9.6 kbps and (b) 115.2 kbps

In our system, the intensity at the Device 0 is sufficient for our experimental setup because the lighting as an access point is assembled 54 WLEDs. However, uplink modules are composed of 2 IREDs due to the mobility as a mobile terminal. Therefore, the signal received to the access point is very weak. For verifying the phenomenon, we examine the signal recovery at the Device0. Fig. 9 shows the received signals captured at the PD and the comparator, respectively. The signal level is within 50 mV, but undefined noise level bigger than the signal was included. It is not easy to restore the original signal from the distorted one. By using amplifier between photodiode and comparator, we overcome these problems. The clearly recovered signal is shown in Fig. 9.

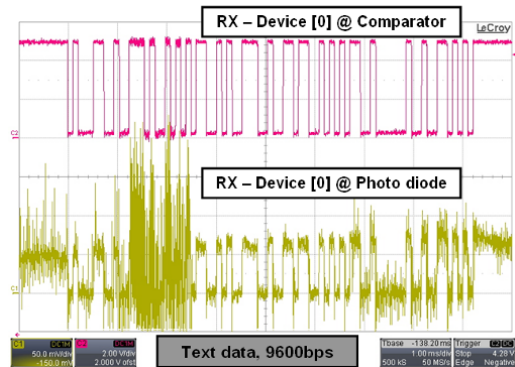

Fig. 9 Waveforms for showing the distorted and the recovered signal

The broadcast of data has been demonstrated with serial communication software (J1communication 4.5, Korea). The data frame for downlink is shown in Fig. 10(a). Payload from Ethernet frames are buffered before their transmission via optical link and then only data field is extracted at the E/S converter. The data is packaged with STX (start of text), LF (line feed), CR (carriage return) and ETX (end of text) for the serial communications. The data form is also reconfigured with \$(defined first character), ID (server name), Destination (device name) and Command. Fig. 10(b) shows a data frame for uplink.

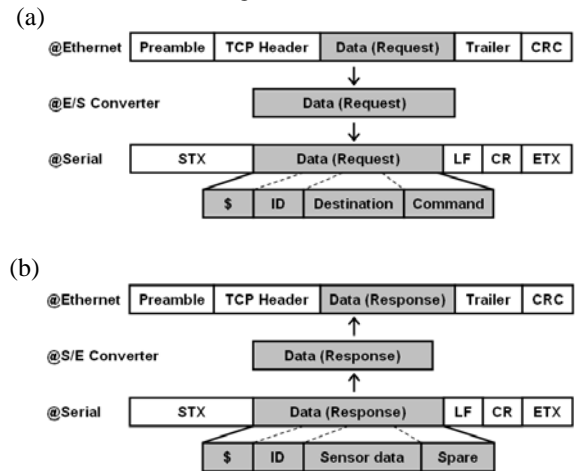

Fig. 10 Payload extraction and packaging:
 (a) Down-link and (b) Up-link

