

Energy Consumptions of Different Building Heating Systems for Various Meteorological Regions of Iran: A Comparison Study

S. Kazemzadeh Hannani, A. Azimi, and S. Nikoofard

Abstract—To simulate heating systems in buildings, a research oriented computer code has been developed in Sharif University of Technology in Iran where the climate, existing heating equipment in buildings, consumer behavior and their interactions are considered for simulating energy consumption in conventional systems such as heaters, radiators and fan-coils. In order to validate the computer code, the available data of five buildings was used and the computed consumed energy was compared with the estimated energy extracted from monthly bills. The initial heating system was replaced by the alternative system and the effect of this change was observed on the energy consumption. As a result, the effect of changing heating equipment on energy consumption was investigated in different climates. Changing heater to radiator renders energy conservation up to 50% in all climates and changing radiator to fan-coil decreases energy consumption in climates with cold and dry winter.

Keywords—Energy Consumption, Heating System, Energy Simulation.

I. INTRODUCTION

REASONABLE energy consumption has particular importance all over the world. Based on the statistical data, energy consumption in buildings are more than other sectors as building sector consumes around 50% of the total energy consumption in developed countries [1]. According to the information provided by IFCO [2] 39% of the total supplied energy is consumed in building sector in Iran (Fig. 1), see IFCO official website for details.

According to the data provided by NIGC [3], 72% of the consumed energy in building sector is used for heating the buildings which means that research in energy conservation in building sector is highly important and estimation of energy consumption in building is essential. Correct estimation of annual loads of building requires an exact and correct model of integrated building consisting of modeling the building, heating equipments, and taking into account the interaction of

other factors such as controls, consumer behavior and weather conditions. Energy simulation, which is based on this model, can solve the equations dynamically in small intervals (hour-by-hour, minute-by-minute and in some special cases second-by-second).

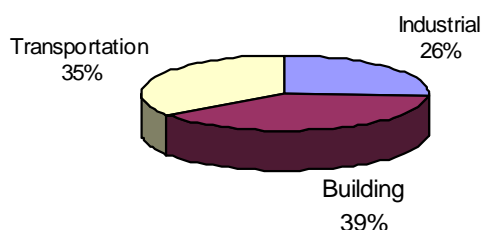

Fig. 1 Amount of energy consumption in each sector of Iran

In order to provide the above capability, a computer code has been developed in this work for simulating energy consumption in conventional systems such as heaters and radiators [4]. In this investigation, modeling and comparing energy consumptions in heater, radiator and fan coil equipments have been performed. Based on the available heating systems and utilities in Iran, different climates and consumer behavior, energy consumption simulation is performed and the impact of climate on energy consumption of heating systems is also considered.

II. THEORY

A building comprises of different components that have complex interactions with each other. Robust and complete analysis of energy consumption needs simulation of the dynamic and complex interaction between the building components, HVAC and the environment.

Energy consumption simulation is based on load and energy calculation and HVAC design. Once the maximal gained load is approximated, the appropriate HVAC system can be designed and energy calculation can be performed for compensation of the gained load during a year [5].

Even though the procedures for estimating energy requirements vary in their degree of complexity, they have three common elements:

1. Space load,
2. Secondary equipment load,
3. Primary equipment energy requirements [6]-[8].

Control system model is considered as another element which can be added to the above and its addition can be

S. Kazemzadeh Hannani is with the Centre of Excellence in Energy Conversion (CEEC), School of Mechanical Engineering, Sharif University of Technology, Azadi Ave., P.O. Box 11155-9567, Tehran, Iran (corresponding author to provide phone: 98-21-6616-5683; fax: 98-21-6616-5680; e-mail: hannani@sharif.edu).

A. Azimi was with the Centre of Excellence in Energy Conversion (CEEC), School of Mechanical Engineering, Sharif University of Technology, P.O. Box 11155-9567, Tehran, Iran (e-mail: aazimi@alum.sharif.edu).

S. Nikoofard is with the Department of Mechanical Engineering, Faculty of Engineering, Dalhousie University, P.O. Box 1000, Halifax NS B3J 2X4, Canada (e-mail: s.nikoofard@dal.ca).

justified in relation to elements number 1 and 2 [6], [7]. Secondary equipment refers to equipment that distributes the heating, cooling, or air ventilating to the conditional spaces, while primary refers to central plant equipment that converts

fuel energy to heating or cooling effects. Fig. 2 shows the main elements in energy simulation and their relation to each other.

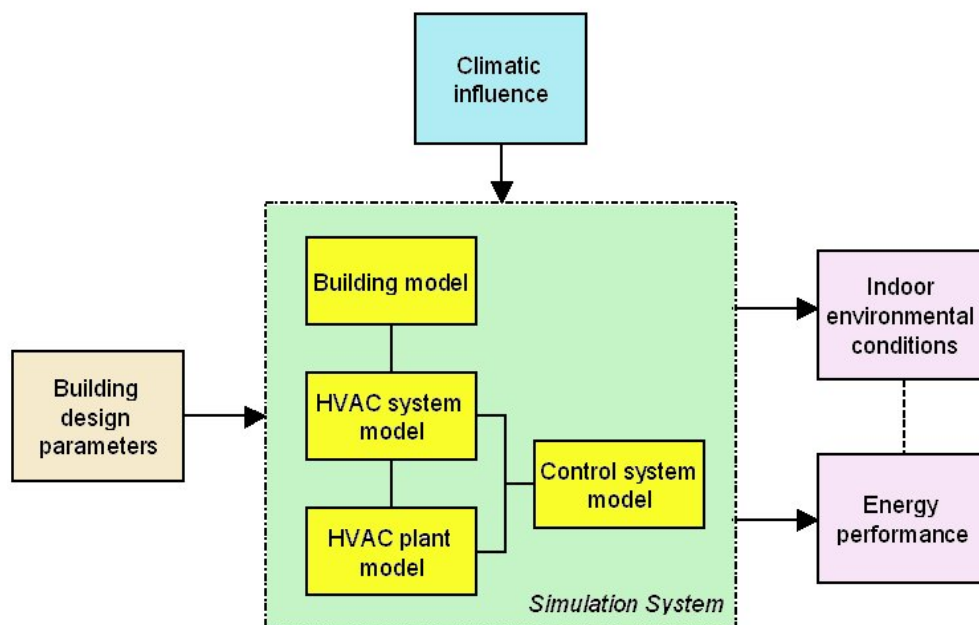

Fig. 2 Major elements of building energy simulation

The inputs to the simulation system are the building descriptions and design parameters. The boundary condition is the climatic condition of the location. The outputs are the data for building energy consumption, peak demand and indoor environmental conditions. Usually, the modeling target is to provide comfortable indoor conditions while maintaining acceptable levels of fuel consumption; to optimize the system performance; or to compare different design options based on their life cycle costs. An additional module is required for the economic analysis.

The first step in calculating energy requirements is to determine the space load, which is the amount of energy that must be added to or extracted from a space to maintain thermal comfort. The simplest procedures assume that the energy required maintaining comfort is only a function of the outdoor dry-bulb temperature. More detailed methods consider solar effects, internal gains, heat storage in the wall and interiors, and the effects of wind on both building envelop, heat transfer and infiltration. The most sophisticated procedures are based on hourly profiles for climatic conditions and operational characteristics for a number of typical days of the year or on 8760 h of operation per year [8].

It is noted that energy calculations, in the first step, are based on average use and typical weather conditions rather than maximum use and worst case weather condition [8]. The second step transfers the space load to a load on the secondary equipment. This can be a simple estimate of duct or piping losses or gains, or a complex hour-by-hour simulation of an air system, such as variable air volume with outdoor air

cooling. This step must include the calculation of all forms of energy required by the secondary system, i.e., electrical energy to operate fans and/or pumps, as well as energy delivered to the building boundary [8].

The third step calculates the fuel and energy required by the primary equipment to meet these loads and peak demand on the utility system. It considers equipment efficiencies and part load characteristics [8].

In this paper, the equations for calculating temperature of different nodes of heating system cycle is obtained, based on the heat transfer equations relating the secondary system with space, and considering the relation between primary and secondary equipment.

III. MODELING

In this section the model which was used in this investigation is described briefly. To simulate a system we need a mathematical modeling which could calculate thermodynamic behavior of building (loading model), thermodynamic process of HVAC (secondary equipment model) and required energy to meet the energy demands (primary equipment model).

At first the space load should be calculated. Two principle methods for calculating the space load are: 1) Heat balance method, 2) Transfer function method. The former method is the fundamental method which is based on the first law of thermodynamic. This method has fewer assumptions than transfer function method, so it is more flexible but it needs more time and accuracy. Transfer function method is a

method between simple methods, e.g. Bin method, and complex method, e.g. Heat balance method [8].

Transfer function method was used for calculating the space load and space temperature. In fact the E20-II HVAC System Design Software [9] was used to compute the hour-by-hour load and then these data was used for estimation of energy consumption. The heat extraction rate equation was used for computing the space temperature by coupling to other equations of the model.

The next step is secondary equipment model. The aim of this paper is modeling the common heating systems in Iran such as heater, radiator and fan coil. Up to our knowledge, none of the commercial or research codes model these systems, except fan coil units that are rarely used in Iranian dwellings. So an appropriate model, which considers traditional heating systems consistent with Iranian culture, is necessary.

$$\text{Heat extraction rate of the system (hourly)} = \text{control degree} \times \text{mass flow rate of gas (kg/s)} \times \text{heater efficiency} \times \text{fuel heating value (J/kg)} \quad (1)$$

$$\text{Fuel consumption (hourly)} = \text{control degree} \times \text{mass flow rate of gas (kg/s)} \times 3600 \quad (2)$$

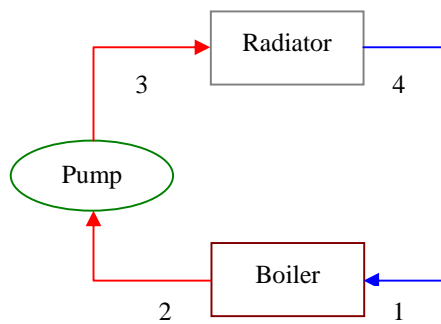

Fig. 3 Major Elements of Central heating system

B. Radiator

Radiators are types of heat exchanger designed to transfer thermal energy from one media to another. In buildings, a radiator is a heating device, which is warmed by steam from a boiler or hot water being pumped into it from a water heater (usually, if not quite accurately, referred to as a "boiler"). In a building, radiators transfer the majority of their heat by radiation and by natural convection.

To model a radiator modeling the whole cycle of central heating system is needed. However, considering all factors which effect on cycle is too complex. So many assumptions are needed in this case. In this paper, the equations for calculating temperature of different nodes of heating system

$$\frac{1}{2} M_L C_p (T_3 + T_4) + (1 - \theta) m C_p (T_3 - T_4) - \frac{C_1 \Delta t}{2^n} \left[(T_3 + T_4 - 2\bar{T}_a)^n - \theta (T_3 + T_4 - 2\bar{T}_a)^{n-1} (T_3 + T_4) \right] = \left[\frac{1}{2} M_L C_p - m C_p \theta + \frac{C_1 \Delta t}{2^n} \theta (T_3 + T_4 - 2\bar{T}_a)^{n-1} \right] T_3' + \left[\frac{1}{2} M_L C_p + m C_p \theta + \frac{C_1 \Delta t}{2^n} \theta (T_3 + T_4 - 2\bar{T}_a)^{n-1} \right] T_4' \quad (4)$$

C. Fan Coil

Fan-coil units provide heating, cooling, or both to

A. Heater

The most common heating system in Iran is gas or oil heater. The supplied heat is transfer directly to the space. In this model it is assumed that the heater has a control, which could change the amount of transferred heat to the space. The degree of control varies from 0 to 1, zero means that the heater is off and one means that the heater works with full capacity. In heater modeling main effective factors are: heater capacity, amount and type of control, and the efficiency profile. It is assumed that the whole building is one block. So the sum of capacity of all heaters was assumed as the capacity of one heater. With these assumptions the heat extraction rate of system and fuel consumption are achieved by following equations:

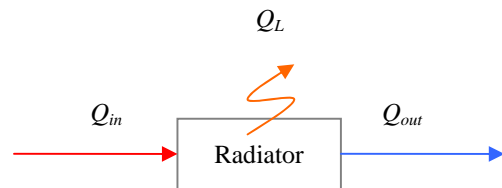

Fig. 4 Radiator heat transfer

cycle is obtained, based on the mass conservation and conservation of energy equations relating the secondary system with space, and considering the relation between primary and secondary equipment. Fig. 3 shows the elements of assumed cycle, and Fig. 4 shows the heat transfer of radiator.

Heat losses from radiator can be written as [8]:

$$\dot{Q}_L = C_1 (\bar{T}_L - \bar{T}_a)^n \quad (3)$$

By solving conservation of energy and mass conservation equations for radiator by using finite element method to discrete the time expression, the radiator equation achieves as follow:

individual spaces. Fan-coil units usually discharge air directly from their enclosures, although some may be installed with short ducts.

The main components of fan-coil units are a fan and one or two coils. Units may have separate heating and cooling coils or a single water coil may be used for both functions. The coils may operate with hot water, chilled water, electric resistance, or rarely, steam. The output of a fan-coil unit can be controlled by cycling the fan, by controlling the speed of the fan, by throttling the flow of water in the coil, or by turning electric coils on and off. Units typically have control panels to allow occupants to select heating or cooling, to select the fan speed, and to control outside air ventilation, if any is available. Automatic controls may shut off flow through hydronic coils when the fan stops, and they may perform other functions. The fan-coil unit may have thermostatic controls that are entirely self-contained, or the fan-coil unit may have actuators that are powered by external thermostats. Fan coil is modeled in this work employing the same procedure as radiator. Note that the heat loss equation of radiator differs from the fan coil which is as follows [8]:

$$\dot{Q}_f = \varepsilon C_{\min} (T_{h,i} - T_{c,i}) \quad (5)$$

$$(1-\theta)m C_p (T_1 - T_2) + \frac{1}{2} \overline{M_L C_p} (T_1 + T_2) + Q_s = \left(\frac{1}{2} \overline{M_L C_p} - m C_p \theta \right) T_1' + \left(\frac{1}{2} \overline{M_L C_p} + m C_p \theta \right) T_2' \quad (8)$$

$$-\frac{A_H \Delta t}{2R_H} [(1-\theta)(T_2 + T_3) - 2T_\infty] + m C_p (1-\theta)(T_2 - T_3) + \frac{1}{2} M_H C_p (T_2 + T_3) = \left(\frac{1}{2} M_H C_p - m C_p \theta + \frac{A_H \Delta t}{2R_H} \theta \right) T_2' + \left(\frac{1}{2} M_H C_p + m C_p \theta + \frac{A_H \Delta t}{2R_H} \theta \right) T_3' \quad (9)$$

$$-\frac{A_C \Delta t}{2R_C} [(1-\theta)(T_4 + T_1) - 2T_\infty] + m C_p (1-\theta)(T_4 - T_1) + \frac{1}{2} M_C C_p (T_4 + T_1) = \left(\frac{1}{2} M_C C_p - m C_p \theta + \frac{A_C \Delta t}{2R_C} \theta \right) T_4' + \left(\frac{1}{2} M_C C_p + m C_p \theta + \frac{A_C \Delta t}{2R_C} \theta \right) T_1' \quad (10)$$

E. Heat Extraction Rate

Space temperature is derived from the heat extraction rate equation:

$$\sum_{i=0}^1 p_i (\dot{q}_{x,\theta-i\delta} - \dot{q}_{c,\theta-i\delta}) = \sum_{i=0}^2 g_i (t_{rc} - t_{r\theta-i\delta}) \quad (11)$$

IV. SIMULATION

The simulation in this paper is based on 8760 hour-by-hour method. The equations of elements and space temperature equation should be solved simultaneously. For reducing the complexity of computation the space temperature was assumed constant in each step of iteration and then it was computed from heat extraction rate equation. In each step the temperatures of nodes are computed by using the elements equations. After computing all nodes temperature and heat

$$C_{\min} = (\dot{m} C_p)_{\min} \quad (6)$$

Then the fan coil equation is:

$$(1-\theta)m C_p (T_3 - T_4) + \frac{M_L C_p}{2} (T_3 + T_4) - \varepsilon C_{\min} \Delta t (T_3 - T_{air}) = \left(\frac{1}{2} M_L C_p - m C_p \theta \right) T_3' + \left(\frac{1}{2} M_L C_p + m C_p \theta \right) T_4' \quad (7)$$

D. Boiler and Pipes

The method to drive equations of boiler, feed and return pipes are the same as radiator. Here the control volume is boiler or feed or return pipe. The boiler, Feed pipe and Return pipe equations are as follows, respectively:

load of equipments for every hour of one year, energy consumption and fuel demand is calculated. Finally, for validating and verifying the model, the gas bills of dwellings are used for comparison.

V. CASE STUDY

For explaining the simulation and the discussing results two buildings (Building No.1 and Building No.2) in different climates are selected. The following data is input to the simulating code for both buildings:

1. Design factors of buildings,
2. Conventional Heating systems in Iran (heater, radiator, fan-coil),
3. Eight Climates of Iran (Fig. 5),
4. Consumer behavior.

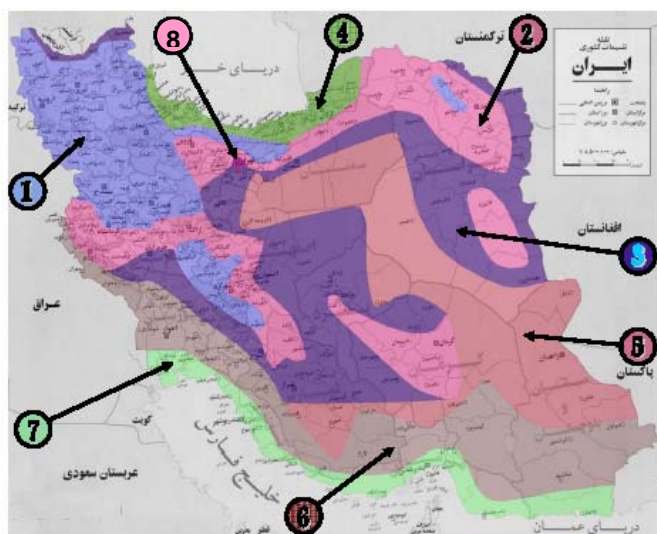

Fig. 5 Climates of Iran

A. Building No.1

Total area of this two-floor building is 240 m². Both floors have the same plan and lighting is through the northern windows and a southern glazing door (80% of this door is made of glass). The western and eastern views have no windows. The building is northern and the floors are connected with stairs. External walls are constructed of 25 cm thick bricks and covered with stone. Internal layer is covered by plaster and internal walls are 13 cm thick and covered with plaster. The floors are tiled and the roof is asphalted. Windows are made of 4 mm thick glasses and metal frames. Plan of this building is sketched in Fig. 6 and additional information is provided in Tables I and II.

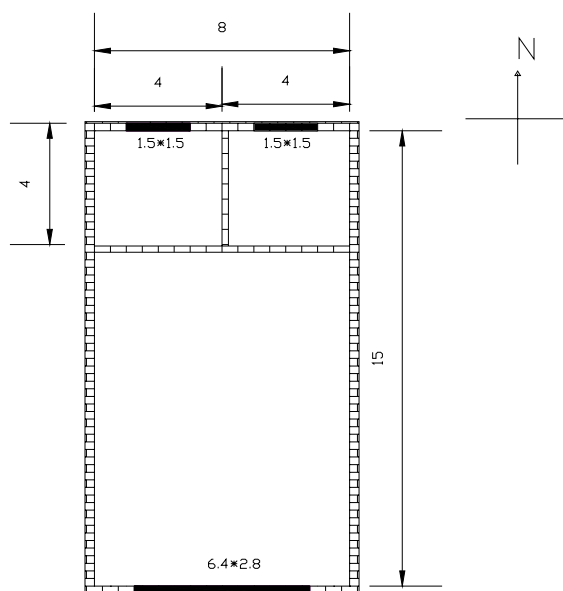

Fig. 6 Building No. 1 Plan for the First and Second Floors

TABLE I
INFORMATION OF STRUCTURE LAYERS OF BUILDING NO.1

Layers	Thickness (mm)	Thermal Resistance (m ² ·K/W)
Internal Walls	130	0.46
External Walls	250	0.60
Ceiling of First Floor	270	0.72
Ceiling of Second Floor	330	1.66

TABLE II
DIMENSIONS OF BUILDING NO.1 WINDOWS

	Dimensions (m)	
	Northern	Southern
First and Second Floors	1.5*1.5	2.8*6.4
	1.5*1.5	-

B. Heating system of Building No.1

This building uses a central heating system fueled by natural gas. Hot water for radiators is supplied by cast iron boilers with burner capacity of 37000 W. The pipes are buried under the floors, and a pump is installed to circulate hot water. Acoustat is adjusted on 75°C to turn off the burner. Another Acoustat adjusts hot water pipes on 70°C to shut off the valves.

C. Building No.2

Total area of this three-floor building is 80 m² where plan of the floors are not the same, lightening is through the northern and southern windows. The western and eastern views have no windows. The building is northern and the floors are connected with stairs. External walls are 25 cm thick and face brick. Internal layer is covered by plaster and internal walls are 14 cm thick and covered with plaster. The floors are tiled and the roof is asphalted.

On the first floor there exist a northern window and a southern window made of 4 mm thick glasses and metal frames. On the second floor there are a northern window and two southern windows similar to the third floor. Plan of this building is sketched in Fig. 7 and additional information is provided in Tables III and IV.

D. Heating system of Building No.2

One 11000 W heater is installed in each floor consuming natural gas.

TABLE III
INFORMATION OF STRUCTURE LAYERS OF BUILDING NO.2

Layers	Thickness (mm)	Thermal Resistance (m ² ·K/W)
Internal Walls of First Floor	140	0.50
Internal Walls of Second Floor	140	0.44
Internal Walls of Third Floor	140	0.50
External Walls	120	0.35
Ceiling of First Floor	190	0.50
Ceiling of Second Floor	190	0.44
Ceiling of Third Floor	230	1.31

TABLE IV
 DIMENSIONS OF BUILDING NO.2 WINDOWS

	Dimensions (m)	
	Northern	Southern
First Floor	1.5*1.5	1.8*3.5
Second Floor	1.5*1.5	-
	-	0.8*2.65
Third Floor	1.5*1.35	1.5*1.6
	-	0.85*2.6

VI. RESULTS AND DISCUSSION

In building No.1, using central heating system and radiator, energy consumption is calculated for each scenario by changing system parameters and it is compared to the real amount of energy which is calculated based on the gas bills of

this building in one year. Radiator was replaced by fan-coil and the same parameters were changed so that the systems could be compared in similar conditions. This experiment was repeated in all eight climates and the results were compared.

In building No.2, using simple independent heating system such as heater, energy consumption is calculated for each scenario by changing system parameters and it is compared to the real amount of energy which is calculated based on the gas bills of this building in one year. Heater was replaced by radiator and the same parameters were changed so that the systems could be compared in similar conditions. This procedure was repeated in all eight climates and the results were compared.

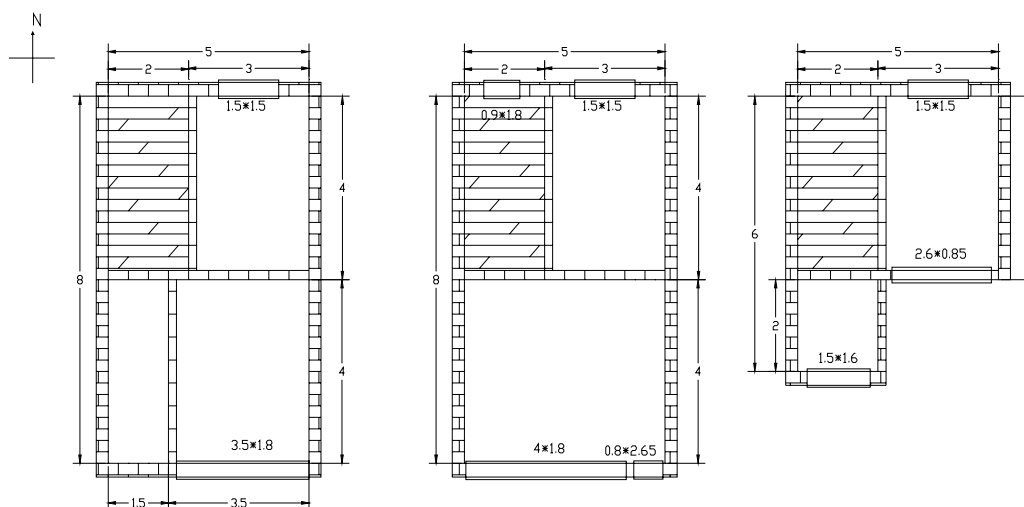

Fig. 7 Building No. 2 Plan (First, Second and Third Floors in order from left to right)

The results are summarized in Tables V and VI. Fig. 8 shows energy consumption and absolute difference of energy for two cases in building No.1. Fig. 9 shows energy consumption and absolute difference of energy for two cases in building No. 2.

According to Fig. 8 where radiator is replaced by fan-coil reduction of energy consumption is quite obvious in some cities such as Tabriz (climate 1), Kerman (climate 2), Isfahan (climate 3), and Tehran (climate 8). Note that very cold and dry climate is specific character of these cities.

According to Fig. 9 where heater is replaced by radiator, reduction of energy consumption is quite obvious in all cities. This reduction is more pronounced in some cities such as Tabriz with dry and long cold winter climate and is practically negligible in Ahwaz with moderate winter temperatures. Based on information provided in Table VI, replacement of heater with radiator is mandatory in all climates of Iran in order to reduce energy consumptions especially in climates 1 to 4 where the potential of energy conservation is up to 50%. This result is highly important because heater is the most widely used heating system in Iran. Comparing the energy consumption of fan-coil to radiator, although fan-coil has a better controlling system than radiator, in some cases its performance is worse than radiator. Further, in some cases the

reduction in energy consumption of fan-coil is not enough to compensate the capital and maintenance costs of it. When fan-coil is used for both cooling and heating, the former conclusion may not be valid.

VII. CONCLUSION

In this paper a research code has been developed to compute energy consumption in buildings with different heating systems in Iran. In the first step, a dynamic model was developed based on the type of residential buildings and heating systems. Dynamic simulation was performed and the effect of climate change was studied.

Changing conventional independent heaters with central heating systems and radiators as secondary equipment will result in energy saving in all climates especially in climates with long cold and dry winter. But changing radiator to fan-coil is efficient only in climates with dry and cold winter. This change increases energy consumption in climate with moderate winter such as climate 7 and has no considerable impact in climates 5 and 6.

TABLE V
 ENERGY CONSUMPTION IN DIFFERENT CLIMATES WITH CHANGING HEATING SYSTEM FOR BUILDING NO.1

Climate No.	City Name	Energy consumption (J)		Relative Energy Saving Potential (%)	Absolute Energy Saving Potential (J)
		Fan-coil	Radiator		
1	Tabriz	160.2E+9	180.8E+9	11.40	20.6E+9
2	Kerman	96.0E+9	105.7E+9	9.18	9.7E+9
3	Isfahan	107.5E+9	120.2E+9	10.57	12.7E+9
4	Rasht	122.2E+9	125.8E+9	2.87	3.6E+9
5	Zahedan	74.6E+9	76.1E+9	1.96	1.5E+9
6	Ahwaz	48.0E+9	40.9E+9	-17.14	-7.0E+9
7	Tehran	102.0E+9	109.7E+9	7.01	7.7E+9

TABLE VI
 ENERGY CONSUMPTION IN DIFFERENT CLIMATES WITH CHANGING HEATING SYSTEM FOR BUILDING NO.2

Climate No.	City Name	Energy consumption (J)		Relative Energy Saving Potential (%)	Absolute Energy Saving Potential (J)
		Radiator	Heater		
1	Tabriz	75.2E+9	126.4E+9	40.54	51.2E+9
2	Kerman	37.9E+9	75.1E+9	49.56	37.2E+9
3	Isfahan	45.4E+9	81.0E+9	43.97	35.6E+9
4	Rasht	50.4E+9	90.1E+9	44.07	39.7E+9
5	Zahedan	25.0E+9	50.1E+9	50.19	25.2E+9
6	Ahwaz	12.8E+9	26.6E+9	51.80	13.8E+9
7	Tehran	42.4E+9	72.0E+9	41.11	29.6E+9

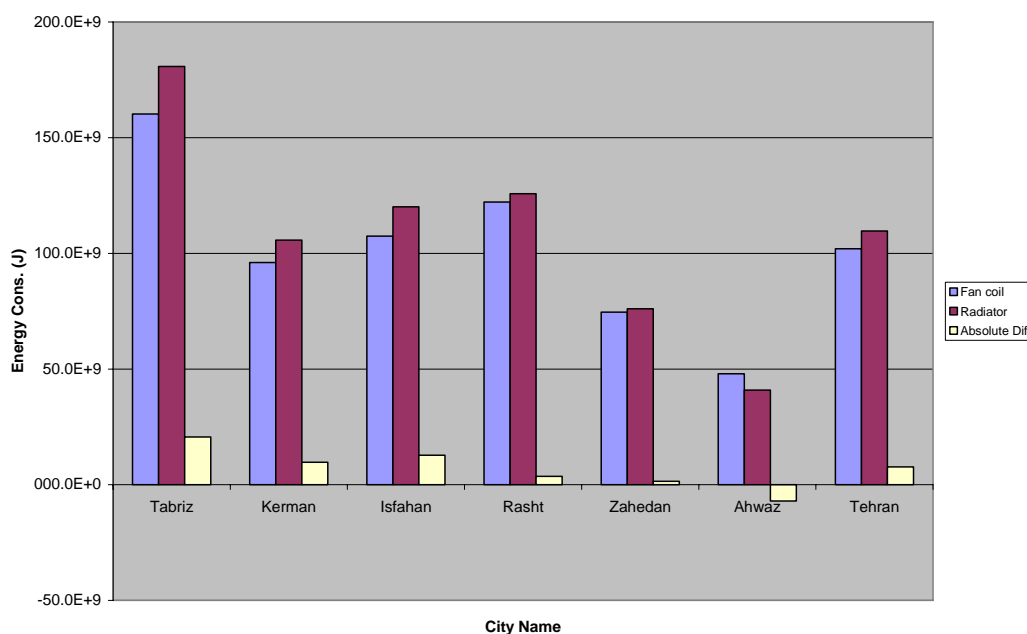

Fig. 8 Comparison between fan-coil and radiator for Building No.1 in different climates

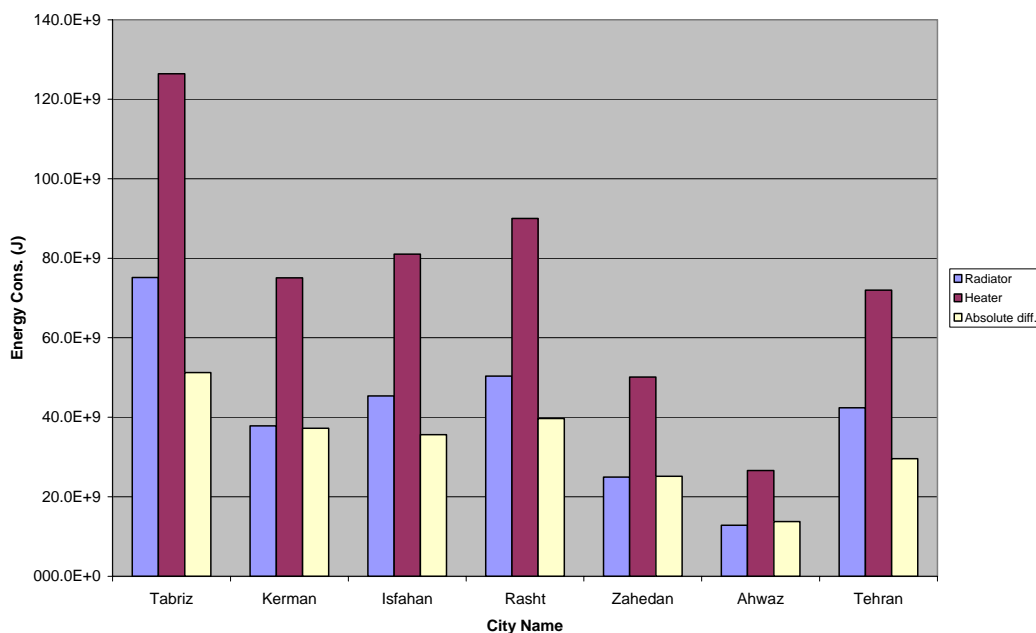

Fig. 9 Comparison between radiator and heater for Building No.2 in different climates

ACKNOWLEDGMENT

The authors express their sincere gratitude towards Iran Fuel Conservation Organization (IFCO) for providing the partial financial support for this research and the Office of Vice Chancellor for research of Sharif University of Technology.

NOMENCLATURE

\dot{Q}_L	heat losses rate from radiator
C_1	constant determined by test
\bar{T}_L	radiator water average temperature
\bar{T}_a	space average temperature
n	radiator power equal to 1/3
M_L	water mass inside the radiator
C_p	specific heat
T_1	boiler input temperature
T_2	boiler output temperature
T_3	radiator input temperature
T_4	radiator output temperature
m	water mass in circulation
\dot{Q}_F	fan oil heat loss rate
C_{min}	minimum heat capacity of cold and hot liquid
$T_{h,i}$	hot liquid entering temperature (here water)
$T_{c,i}$	cold liquid entering temperature (here air)
T_{air}	space temperature
\dot{Q}_S	boiler heat loss rate
A_H	heat transfer area of feed pipe
R_H	thermal resistance of feed pipe

M_H	water mass of feed pipe
T_∞	outdoor temperature
A_C	heat transfer area of return pipe
R_C	thermal resistance of return pipe
M_C	water mass of return pipe
p_i, g_i	Coefficients of transfer function
\dot{q}_c	cooling load at different times
t_i	space temperature for calculation of cooling load
t_r	real space temperature for different times

Greek Letters

θ	Coefficient which determine solving should be explicit or implicit
ε	fan coil efficiency

Superscripts

'	refers to next time
---	---------------------

REFERENCES

- [1] A., Novoselac, "Combined airflow and energy simulation program for building mechanical system design," PhD dissertation, The Pennsylvania State University, USA, 2005.
- [2] Iranian Fuel Conservation Organization (IFCO). (2006). Available: http://www.ifco.ir/building/building_index.asp
- [3] National Iranian Gas Company (NIGC). (2003), Internal Unpublished Report.
- [4] A., Azimi, F., Shahmohammadi, and S., Kazemzadeh Hannani, "Dynamic Simulation of Heating Energy Consumption of Iranian Residential Buildings-Central Heating System," in *Proc. 2nd Int. Conf. on Applied Thermodynamics*, Istanbul, Turkey, May, 2005.
- [5] J. L. M., Hensen, (1998). *Modeling and simulation for HVAC design and performance evaluation*. Available: [http://www.starth.ac.uk/Departments/ESRU/Publications/applmod a hvac.paper.htm](http://www.starth.ac.uk/Departments/ESRU/Publications/applmod%20a%20hvac.paper.htm)
- [6] S. C. M., Hui, "Simulation based design tools for energy efficient buildings in Hong Kong," *Hong Kong Papers in Design and Developments*, vol. 1, 1988, pp. 40-46.

- [7] S. C. M., Hui, and K. P., "Cheung, Application of building energy simulation to air conditioning design," in *Proc. Mainland-Hong Kong Seminar'98*, Beijing, China, March 1998, pp. 12-20.
- [8] *Fundamentals, American Society of Heating, Refrigerating and Air Conditioning Engineers*, ASHRAE, Atlanta, USA, 1997.
- [9] E20-II HVAC System Design Software, HAP (Hourly Analysis Program) Modules: Load Estimating & Energy Use Analysis, Carrier Corporation, (2006), Available: http://www.commercial.carrier.com/commercial/hvac/general/0,,CL11_DIV12_ETI495_MID1580,00.html.



S. Kazemzadeh Hannani is member of the Center of Excellence in Energy Conversion and a Professor of Mechanical Engineering at the School of Mechanical Engineering, Sharif University of Technology, Islamic Republic of Iran. He received his doctorate in Mechanics from University of Lille-1 in France in 1996. His research interests involve finite element, heat transfer, and turbulence modeling.



A. Azimi is Member of **Iranian Elites Association** and member of **ASME**. He received his Ph.D. in mechanical engineering from School of Mechanical Engineering, Sharif University of Technology, Islamic Republic of Iran, in 2007.

His research interests involve Computational Fluid Dynamics (CFD), direct/inverse heat transfer problems and energy conservation in buildings and oil, gas and petrochemical industries.

Dr. Azimi was awarded Ph.D. excellence student scholarship, Sharif University of Technology for two academics years and Diploma and Prize Awards for the best annual Ph.D. thesis in category "Engineering and Technology" for the year 2007 selected by Iranian Academic Center for Education, Culture and Research (ACECR) in the Twelfth Exhibition of Student Annual Thesis, 2008, Tehran. Iran.