

Optimization of Material Removal Rate in Electrical Discharge Machining Using Fuzzy Logic

Amit Kohli, Aashim Wadhwa, Tapan Virmani, and Ujjwal Jain

Abstract—The objective of present work is to stimulate the machining of material by electrical discharge machining (EDM) to give effect of input parameters like discharge current (I_p), pulse on time (T_{on}), pulse off time (T_{off}) which can bring about changes in the output parameter, i.e. material removal rate. Experimental data was gathered from die sinking EDM process using copper electrode and Medium Carbon Steel (AISI 1040) as work-piece. The rules of membership function (MF) and the degree of closeness to the optimum value of the MMR are within the upper and lower range of the process parameters. It was found that proposed fuzzy model is in close agreement with the experimental results. By Intelligent, model based design and control of EDM process parameters in this study will help to enable dramatically decreased product and process development cycle times.

Keywords—Electrical discharge Machining (EDM), Fuzzy Logic, Material removal rate (MRR), Membership functions (MF).

I. INTRODUCTION

MATERIAL removal rate is one of the most important machining characteristic for the metals which are worked under treatment conditions. By decreasing the material removal rate value through electrical discharge machining, surface finish and wear resistance are increased and hence, the friction coefficients of the material are decreased.

Electrical discharge machining is basically electro-thermal non-traditional material removal process which is widely used to produce dies, punches, moulds, finishing parts for aerospace and automotive industry, and surgical components [1]". It is experimentally proved that in EDM research related to improvement in performance measures, optimizing the process variables, supervising and manipulation of the sparking process and clarifying the electrode design & manufacturing. "Pulsed arc discharges occur in the gap filled

with an insulating medium, preferably a dielectric liquid like hydrocarbon oil or de-ionized (de-mineralized) water [2]". In the experimental work and attempt of C.J. Luis, I. Puertas and G.Villa, the study of siliconised or reaction-bonded silicon carbide (SiC) on the die-sinking electrical discharge machining (EDM) to evaluate a material removal rate (MRR) and electrode wear (EW) has been carried out. The author considered five input factors: intensity supplied by the generator of the EDM machine (I), pulse time (ti), duty cycle (η), open-circuit voltage (U) and dielectric flushing pressure (P), over the two previously mentioned response variables. This has been done by design of experiments (DOE). "EDM typically works with materials that are electrically conductive using methods for machining insulating ceramics [3-4]". "The first serious attempt of providing a physical explanation of the material removal during electric discharge machining is of Van Dijck. "The author presented a thermal model together with a computational simulation to explain the phenomena between the electrodes during electric discharge machining [5]". However, as author himself admitted in his study, the number of assumptions made to overcome the lack of experimental data at that time was quite significant. "Schumacher [6] described the technique of material erosion employed in EDM as still arguable. This is because ignition of electrical discharges in a dirty, liquid filled gap, when applying EDM, is mostly interpreted as ion action identical as found by physical research of discharges in air or in vacuum as well as with investigations on the breakthrough strength of insulating hydrocarbon liquids". "The material is removed from tool and work-piece with the erosive effect of the electrical discharges [7]". In relation to the author's research, gap specification estimation in EDM is very confound, so it is not exactly comprehended, but modern advancements in electronic and computerized measuring instruments are adding to new creations and learning's in EDM technology. "The electrical resistance of the dielectric influences the discharge energy and the time of spark initiation [8]". In consideration with of respective research work, the experimental values of the table of AGIE SIT results were compared with Finite Element Analysis (FEA) used by other researchers (D.D. DiBitonto, P.T. Eubank, M.R. Patel, M.A. Barrufet). "Taguchi approach has also been used by many other researchers to analyze and design the ideal EDM process [9]-[11]". Fuzzy logic is one of the artificial intelligence techniques having

Amit Kohli, PhD., is with D.A.V Institute of Engineering & Technology, Jalandhar (Punjab) 144008, India affiliated to Punjab Technical University (e-mail: amechanical_amit@yahoo.com).

Aashim Wadhwa is with D.A.V Institute of Engineering & Technology, Jalandhar (Punjab) 144008, India affiliated to Punjab Technical University (e-mail: baashim.wadhwa@gmail.com).

Tapan Virmani is with D.A.V Institute of Engineering & Technology, Jalandhar (Punjab) 144008, India affiliated to Punjab Technical University (e-mail: ctapan.virmani.3@gmail.com).

Ujjwal Jain is with D.A.V Institute of Engineering & Technology, Jalandhar (Punjab) 144008, India affiliated to Punjab Technical University (e-mail: dujjwaljain_91@yahoo.com).

ability to tackle the problem of complex relations among variables that cannot be accomplished by the traditional methods. Fuzzy logic is a form of many-valued logic; it deals with reasoning that is fixed or approximate rather than fixed and exact. In contrast with "crisp logic", where binary sets have two-valued logic: true or false, fuzzy logic variables may have a truth value that ranges in degree between 0 and 1. The Mamdani implication method is employed for fuzzy inference reasoning in this paper. In this study the application of the fuzzy logic has been used for the optimization of MRR to predict the response.

II. PRINCIPLE OF EDM

The working principle of EDM process is based on the thermoelectric energy. This energy is created between a work piece and an electrode submerged in a dielectric fluid with the passage of electric current. A necessary condition for producing a discharge is ionization of the dielectric. Suitable voltage is applied and intensity of electric field between them builds up. The electrons break loose from the surface of cathode and are impelled towards the anode under field forces. While moving, the electrons collide with the neutral molecules and causing ionization. When this happens, there is a flow of electrons to the anode, resulting in a discharge. The discharge leads to the generation of extremely high temperature causing fusion of the metal and the dielectric fluid at the point of discharge (Fig. 1). The metal in the form of liquid drops is dispersed into space surrounding the electrodes by the explosive pressure of gaseous product in the discharge.

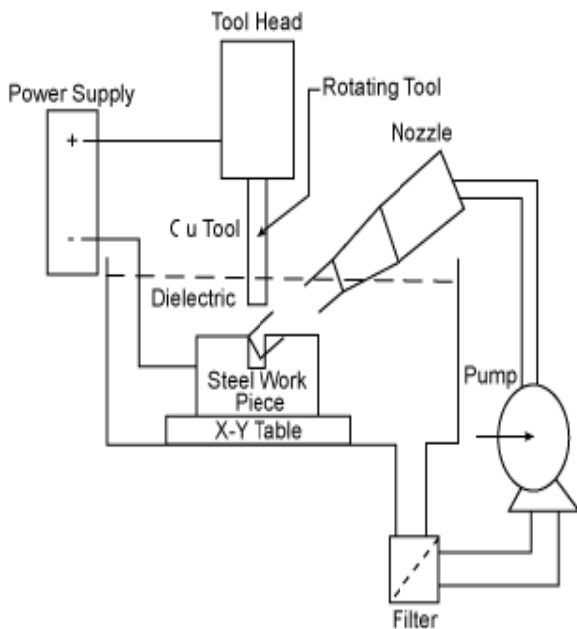

Fig. 1 Set up of Electric Discharge Machining [12]

A. EDM Process Parameters

Based upon some pilot experiments and literature reviews, the various process parameters selected in the study are:

- A. T_{on} -time (μ s): The duration of time the current is allowed to flow per cycle.
- B. T_{off} -time (μ s): The duration of time between the sparks.
- C. Discharge current (I_p): Discharge current is directly proportional to the Material removal rate(MRR).

In this investigation, three factors are being studied and their low and high levels are given in the Table I. The response variable investigated was MRR.

TABLE I
 LEVELS OF INPUT PARAMETERS

Process parameters	Low level (-1)	High level (+1)
Discharge current (I_p) (ampere)	10	45
Pulse on time T_{on} (μ s)	30	900
Pulse off time T_{off} (μ s)	30	600

B. Characteristics of EDM

The model used in the experiment was OSCARMAX EDM (S645). The worktable of dimensions 1000(L) x 600(W) having dielectric of 1200 litres working at maximum current of 120 ampere and power input 12 kVA respectively. The copper was used as a tool material with dielectric fluid. With the development of the transistorized, pure copper became the metallic electrode material of choice because the combination of copper and certain power supply settings enables low wear burning. Commercial grade EDM oil (specific gravity =0.763, freezing point =94°C, viscosity =3 μ m) was used as dielectric fluid. Spark gap considered in the study was between 0.010-0.500 mm to produce spark frequency of 200-500 kHz.

III. EXPERIMENTAL SETUP

Medium Carbon Steel (AISI 1040) with the composition of carbon (0.431%), magnesium (0.660%), phosphorous(0.0292%), sulphur (0.0277%), chromium(0.347%), molybdenum(0.0093%), nickel (0.646), cobalt (0.0069), copper (0.107%), vanadium (0.0178%), and silicon (0.228%) was taken as the work-piece material Fig. 2 describes the flow chart of the experimental process.

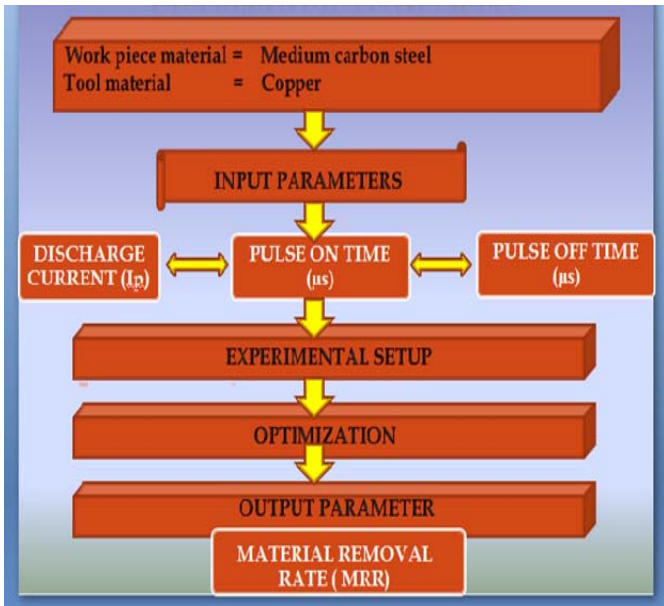

Fig. 2 Flow Chart of the Experiment

IV. FUZZY LOGIC MODEL FOR ELECTRICAL DISCHARGE MACHINING PROCESS (MATERIAL REMOVAL RATE AS RESPONSE)

The modeling of EDM has been done using fuzzy inference system (FIS). In this study, six angular membership functions are selected for fuzzy model (Fig. 3).

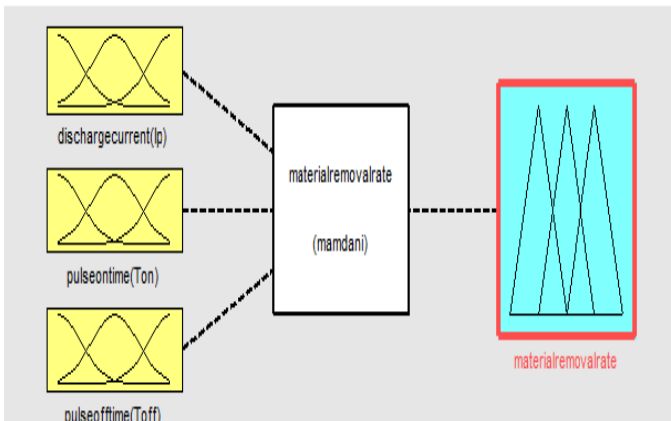
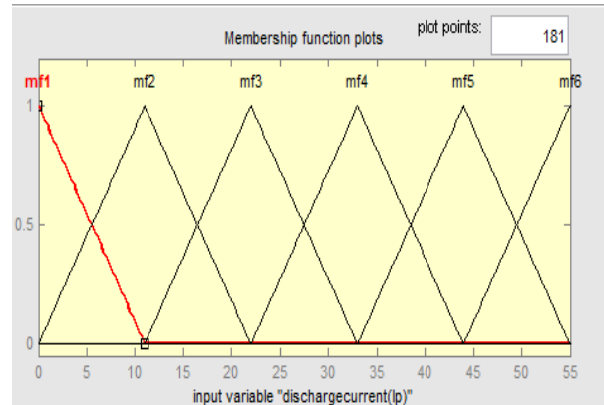

Fig. 3 Fuzzy Logic Model of Electrical Discharge Machining (Response: MRR)

A. Membership Function for the Input and Output Parameters (MRR as Response)

This step is to define linguistic values assigned to the variables by fuzzy sub-sets and their associated membership functions which may be zero or one called the grades of membership. Zero membership value indicated that it is not a member of the fuzzy-set & one represents a complete member. A membership function can have any shape but preferably should be symmetric which includes, trapezoidal, triangular and bell shaped. Six membership functions were generated for

each input variable (Discharge current, pulse on time, pulse off time) as shown in Fig. 4 (a, b and c).



(a)

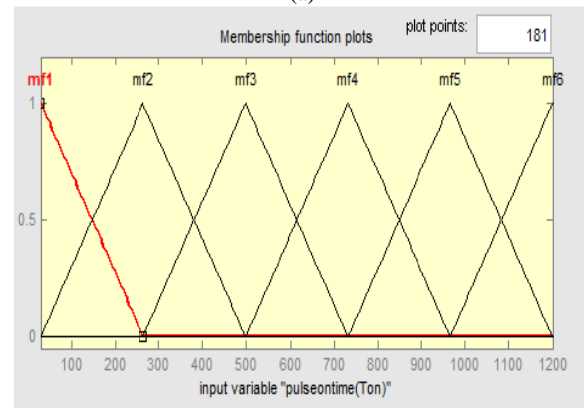

(b)

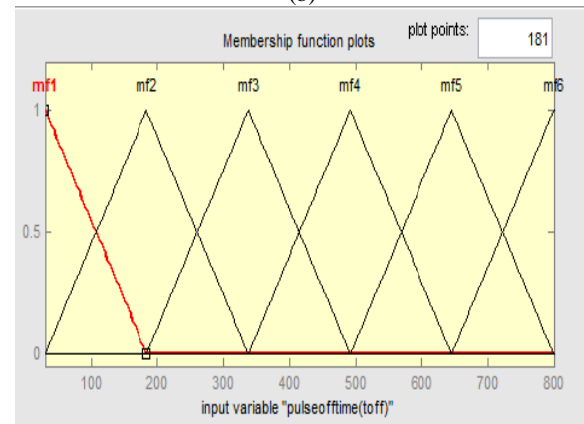

(c)

Fig. 4 Membership Function Plots for input Parameters (a) Discharge current (b) pulse on time (c) pulse off time between the Work-Piece and tool

Membership functions for MRR as output variable of the material is shown in Fig. 5.

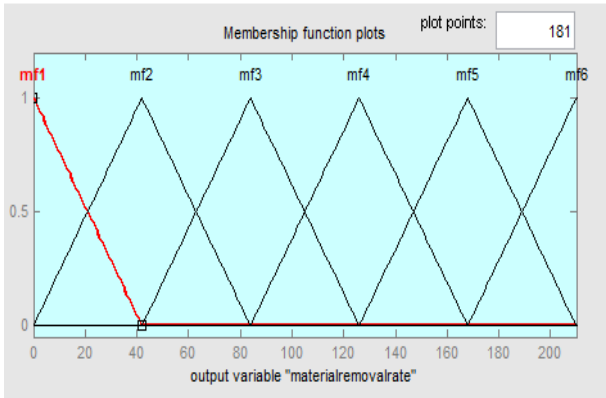

Fig. 5 Membership Functions for Output Parameter (MRR)

B. FIS Rules Employed in Model (MRR as Response)

For obtaining optimized solution, the rules at the base have been defined correctly and these rules were written based upon the experimental results. While preparing the rules, fuzzy method was used. Some selected rules are reported in Fig. 6, using MATLAB 7.9.0 environment using Mamdani-type of fuzzy inference system in fuzzy logic toolbox.

1. If (discharge-current is mf4) and (Ton is mf3) and (Toff is mf3) then (MRR is mf6) (1)
2. If (discharge-current is mf4) and (Ton is mf3) and (Toff is mf6) then (MRR is mf4) (1)
3. If (discharge-current is mf2) and (Ton is mf5) and (Toff is mf5) then (MRR is mf2) (1)
4. If (discharge-current is mf2) and (Ton is mf5) and (Toff is mf2) then (MRR is mf2) (1)
5. If (discharge-current is mf2) and (Ton is mf3) and (Toff is mf5) then (MRR is mf2) (1)
6. If (discharge-current is mf4) and (Ton is mf3) and (Toff is mf3) then (MRR is mf6) (1)
7. If (discharge-current is mf4) and (Ton is mf6) and (Toff is mf3) then (MRR is mf6) (1)
8. If (discharge-current is mf4) and (Ton is mf6) and (Toff is mf3) then (MRR is mf4) (1)
9. If (discharge-current is mf2) and (Ton is mf2) and (Toff is mf2) then (MRR is mf4) (1)
10. If (discharge-current is mf5) and (Ton is mf5) and (Toff is mf5) then (MRR is mf4) (1)
11. If (discharge-current is mf5) and (Ton is mf5) and (Toff is mf4) then (MRR is mf4) (1)
12. If (discharge-current is mf5) and (Ton is mf4) and (Toff is mf5) then (MRR is mf5) (1)
13. If (discharge-current is mf5) and (Ton is mf4) and (Toff is mf2) then (MRR is mf6) (1)
14. If (discharge-current is mf6) and (Ton is mf3) and (Toff is mf3) then (MRR is mf6) (1)
15. If (discharge-current is mf4) and (Ton is mf3) and (Toff is mf3) then (MRR is mf6) (1)
16. If (discharge-current is mf4) and (Ton is mf3) and (Toff is mf3) then (MRR is mf6) (1)
17. If (discharge-current is mf4) and (Ton is mf3) and (Toff is mf3) then (MRR is mf6) (1)
18. If (discharge-current is mf4) and (Ton is mf3) and (Toff is mf3) then (MRR is mf6) (1)
19. If (discharge-current is mf4) and (Ton is mf3) and (Toff is mf3) then (MRR is mf6) (1)
20. If (discharge-current is mf4) and (Ton is mf3) and (Toff is mf3) then (MRR is mf6) (1)

Fig. 6 Formulation of Rules (Response: MRR)

The set of rules along with membership function is shown in rule viewer of fuzzy model (Fig. 7). Fig. 7 reveals that after the formulation of rules, the optimum value of material removal rate at any setting between the low and high limits of the process parameter can be predicted.

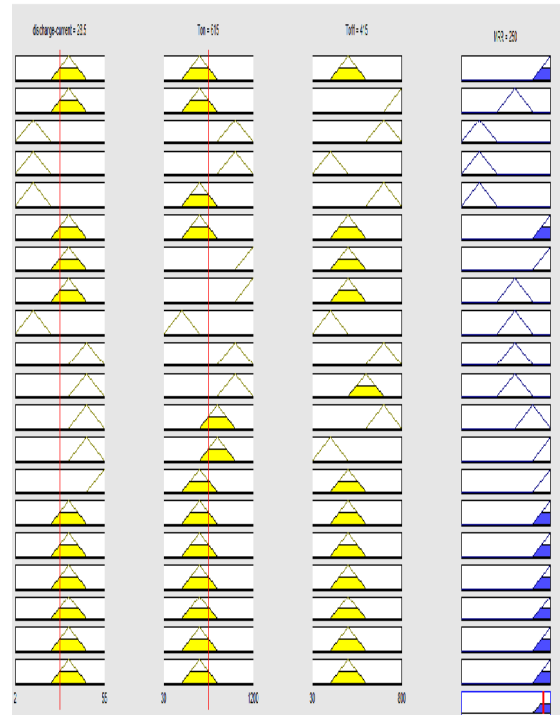
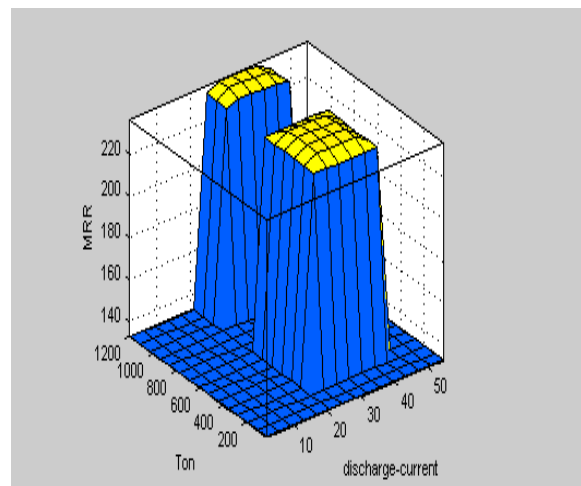

Fig. 7 Rule Viewer of Fuzzy Model (Response: MRR)

Fig. 7 clearly shows that at discharge current 28.5 ampere, pulse on time 615 μ s and pulse off time 415 μ s predicts optimum value of MRR as 250 mm^3/min . Similarly, for different sets of data points in the identified universe of discourse of undertaken parameters various other values of MRR in electrical discharge machining process can be predicted from the fuzzy model.



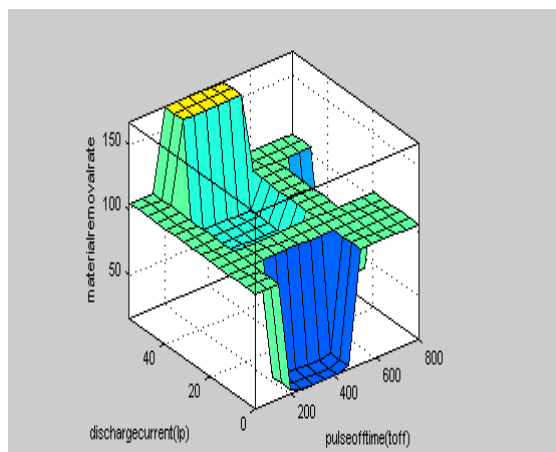

Fig. 8 Control surfaces of Fuzzy model

Control surfaces as shown in Fig. 8 give the interdependency of input and output parameters guided by the various rules in the given universe of discourse for the same.

V. RESULTS AND DISCUSSION

Table II gives the comparison of the predicted responses using fuzzy model and conducted experimental data. There seems to be a good agreement between fuzzy model and experimental values in all cases.

In the present study the total data points involved were 20 and the average percentage error of various responses from fuzzy experimental model was found to be 2.64%. Thus the system gave an overall 97.36% accuracy from fuzzy model. Hence can act as an alternative to conventional modeling method.

TABLE II
 COMPARISON OF FUZZY MODEL AND EXPERIMENTAL DATA FOR VARIOUS RESPONSES

Srno.	Discharge current (Ip) (Ampere)	Pulse on time (T _{on}) (μs)	Pulse off time (T _{off}) (μs)	Work-piece height (H _B) Before	Work-piece height (H _A) After	Time	Experimental value (MRR) $Q = \pi r^2 (H_B - H_A)$ mm ³ /min	Fuzzy values (MRR)	% variation
1	27.5	465	315	58.10	57.30	1.46	247.76	250	0.904
2	27.5	465	315	58.10	57.30	1.46	247.76	250	0.904
3	45	30	30	64.23	63.80	1.32	147.37	140	5.001
4	10	900	600	59.59	58.37	9.19	60.01	62	3.234
5	10	465	315	58.05	56.27	5.25	153.38	166	8.228
6	27.5	30	315	67.32	66.85	1.55	137.82	140	1.582
7	10	30	600	57.23	56.65	1.89	138.83	140	0.843
8	10	900	30	61.55	59.42	15.11	63.77	59	7.480
9	27.5	465	30	62.32	61.83	1.54	143.94	140	2.737
10	27.5	465	315	64.28	63.54	1.38	242.59	250	3.054
11	45	30	600	61.2	60.81	1.25	141.15	140	0.815
12	27.5	465	315	58.46	57.73	1.35	244.63	250	2.195
13	27.5	465	315	70.48	69.50	1.8	246.301	250	1.502
14	27.5	465	315	69.23	68.25	1.78	249.17	250	0.333
15	10	30	30	57.48	56.69	2.56	139.54	140	0.330
16	45	900	600	60.2	59.75	1.15	177.022	183	3.377
17	27.5	900	315	58.20	57.74	1.47	141.56	140	1.102
18	27.5	465	600	63.29	62.85	1.41	140.28	140	0.200
19	45	900	30	70.76	70.28	1.45	149.76	140	6.517
20	45	465	315	68.59	67.88	1.28	250.94	245	2.367

CONCLUSION

- The operation of fuzzy logic to evaluate the response of the output parameter i.e. MRR, has been emphasized in this paper. After comparison between the experimental values and the values generated by fuzzy operation were found to be interrelated with accuracy of 97.36%.
- During the research the fuzzy logic system was found to be more simple to evaluate and responsive than experimental models.
- Present study favours that the fuzzy logic technique can be introduced as a practicable technique to carry out analysis without conducting actual experiments.

REFERENCES

- [1] Ho, K.H., Newman, S.T., 2003 "State of the art electrical discharge machining (EDM)", *International Journal of Machine Tools and Manufacturing*, Vol 43, pp 1287-1300
- [2] Luis, C.J., Puertas, I., Villa, G., 2005 "Material removal rate and electrode wear study on the EDM of silicon carbide", *Journal of Materials Processing Technology*, Vol 164-165, pp 889-896
- [3] Naotake Mohria, Yasushi Fukuzawab, Takayuki Tanic, Nagao Saitoa and Katsushi Furutani. Assisting Electrode Method for Machining Insulating Ceramics. *CIRP Annals – Manufacturing Technology*. Vol 45, Issue 1, 1996, pp 201-204.
- [4] Y.H. Liu, X.P. Lia, R.J. Jia, L.L. Yua, H.F. Zhanga and Q.Y. Li. Effect of technological parameter on the process performance for electric discharge milling of insulating Al₂O₃ ceramic. *Journal of Materials Processing Technology*. Vol 208, Issues 1-3, 2008, pp 245-250.
- [5] Frans Van Dijk. Physico-mathematical analysis of the electro discharge machining process. PhD Thesis Katholieke University te Leuven. 1973.
- [6] Schumacher, B.M., 2004 "After 60 years of EDM, the discharge process remains still disputed", *Journal of Materials Processing Technology*, Vol 149, pp 376-381
- [7] Kuneida, M., Lauwers, B., Rajurkar, K.P., Schumacher, B.M., 2005 "Advancing EDM through fundamental insight into the process", *Annals of CIRP*, Vol 54 issue 2, pp 599-622.
- [8] Marafona, J.; Chousal, A.G., 2006 "A finite element model of EDM based on the Joule effect", *International Journal of Machine Tools and Manufacturing*, Vol 46, issue 6, pp 595-602
- [9] Lin, J.L., Wang, K.S., Yan, B.H., Tamg, Y.S., 2000, "Optimization of the electrical discharge machining process based on the Taguchi method with fuzzy logics", *Journal of Materials Processing Technology*, Vol 102, pp 48-55.
- [10] Tzeng, Y.F., Chen, F.C., 2003, "A simple approach for robust design of high-speed electrical discharge machining technology", *International Journal of Machine Tools and Manufacturing*, Vol 43, issue 3, pp 217-227.
- [11] Marafona, J., Wykes, C., 2000, "A new method of optimizing material removal rate using EDM with copper tungsten electrodes", *International Journal of Machine Tools and Manufacturing*, Vol 40, issue 2, pp 153-164.
- [12] www.triz-journal.com/archives/2009/06/02/ cited at 18/08/2012