

Circuit Breaker and Transformer Monitoring

M.Nafar, A.H.Gheisari, and A.Alesaadi

Abstract—Since large power transformers are the most expensive and strategically important components of any power generator and transmission system, their reliability is crucially important for the energy system operation. Also, Circuit breakers are very important elements in the power transmission line so monitoring the events gives a knowledgebase to determine time to the next maintenance. This paper deals with the introduction of the comparative method of the state estimation of transformers and Circuit breakers using continuous monitoring of voltage, current. This paper gives details a new method based on wavelet to apparatus insulation monitoring. In this paper to insulation monitoring of transformer, a new method based on wavelet transformation and neutral point analysis is proposed. Using the EMTP tools, fault in transformer winding and the detailed transformer winding model were simulated. The current of neutral point of winding was analyzed by wavelet transformation. It is shown that the neutral current of the transformer winding has useful information about fault in insulation of the transformer.

Keywords—Wavelet, Power Transformer, EMTP, Circuit Breaker, Monitoring

I. INTRODUCTION

THE deterioration of insulation in high voltage equipment is a matter of continuous concern. The degradation typically occurs under normal operating conditions although insulation failure may be accelerated under certain in-service condition, such as switching and lightning impulses, over voltages. Power transformers and Circuit Breakers (CBs) are very important for systems reliability studies in power systems. Since large power transformer has belonged to the most expensive and strategically important components of any power generator and transmission system, their reliability is of crucial important for the energy system operation. Failure of a power transformer is a very costly event. Deformation or displacement of winding assemblies is caused by stresses originating from mechanical vibrations during transport or by electromagnetic forces caused by external short-circuit currents and ageing [1–3]. Most serious failures of a large power transformer are due to the insulation breakdown. The partial discharge (PD) that damages insulation because of the gradual erosion is the major source of the insulation failure in high voltage equipment such as transformers [3-6]. CBs

represent one of the most critical power apparatus in the power system. They are used to change topology of the power system to accommodate various configurations in routing the load. CBs are also used to isolate faulted parts of the system as a part of the protective relaying operation. Due to such a critical role, CBs need to be ready to operate at all times and any disruption in their operation may have costly consequences. In order to decrease the cost of maintenance, instead of the periodically predefined planned maintenance, the necessity of maintenance is introduced. It means that e.g. a transformer, circuit breaker, disconnecter unit of a substation will be in operation until the weakest element needs the maintenance. Transformer condition monitoring have following benefits:

- Improve transformer reliability and minimize downtime
- Maximize transformer life with maintenance activity to address abnormal operation
- Safely maximize normal loading without damaging insulation or reducing transformer life
- Provides true dynamic loading capability
- Perform aging analysis of insulation Minimize condition monitoring costs through unified monitoring of various parameters for the entire transformer

The paper is focusing on the failure in insulation of disc to disc transformer winding and on the movement of circuit breaker contacts.

Switching and lightning impulses can accelerate degradation of insulation but in this paper, a new method has been proposed for detection of insulation failure based on wavelet transformation and using lightening impulses.

For on line monitoring, fault (partial discharge) of coil to coil insulation is investigated using EMTP simulation tools. The current of neutral point of winding was measured when $8/20 \mu s$ impulse current is applied to the transformer winding and PD model was located at different positions in the winding. This current was analyzed by the Db2 in wavelet packets.

II. CIRCUIT BREAKER

Circuit breakers are very important elements in the power transmission line so monitoring the events gives a knowledgebase to determine time to the next maintenance. There are numerous methods to examine circuit breakers, but now, just two from them being covered here: a low current test and a high current one. The given results show significant difference in the shape of the displacement-time function of the breaker. While in case of low current test, there is no swing in the displacement-time diagram, in the high one a swing might be observed which means that (because of

Mehdi Nafar is with Islamic Azad University – Marvdasht Branch, Fars, Iran (corresponding author to provide phone: 917-301-8583; fax: 728-333-8686; e-mail: m.nafar@miau.ac.ir)

Amirhossein Gheisari, is with Islamic Azad University - Fars Science and Research Branch, Iran, (e-mail: amir.gheisari@gmail.com)

Alireza Alesaadi, is with Islamic Azad University - Kazerun Branch, Iran, (e-mail: Alesaadi@kau.ac.ir)

electrodynamics' forces) the breaker contacts are slowing down or reverses their movement direction for a short time in an open-close sequence. This phenomenon has to be taken into account at the hardware design phase. An other requirement –equipment separation from high potential parts-involves the problem.

In fig.1 there is the simplified schematic diagram of the breaker monitoring equipment. Two light sources emit 10 μ m light ray which are interrupted by the rotating disc. Sizes of 10 mil width holes are manufactured to the disk to chop the light. This pattern secures the appropriate resolution of speed. Receivers sense square pulse which carries the velocity. In this figure only one phase is shown. It must be mentioned that at high voltage breakers three set of sensor unit needed, but for medium voltage breakers one set is enough.

The capture circuit may be connected to a PC to download the stored data, and with a special software further analysis can be made. The capture circuit has the responsibility to communicate with the SCADA system if any kind of problem concerning the circuit breakers would begin to develop. Breaker trigger signal are connected into the capture circuit to act as a start signal for the measurement. Fig 2 shows a solution for the communication.

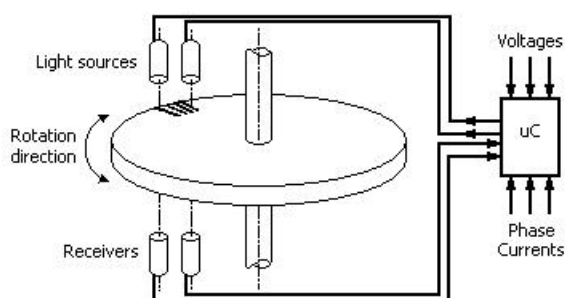

Fig.1 Schematic diagram of circuit breaker

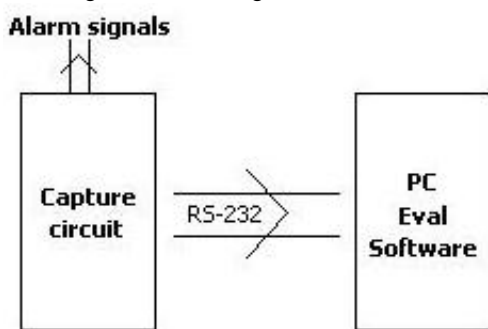

Fig. 2: Capture unit PC communication

In fig.3 an open-close sequence of a circuit breaker is drawn. The closing time approximately 57 msec while the opening time is 49msec. It can be seen that this trial was made at 50A which is relative low current. At high currents if there is a swing in the displacement-time function of the breaker contacts that predict the blowing up of the breaker. Therefore if this kind of swing begins to develop, the monitoring system as to send an alarm signals to the SCADA system. That is why it is necessary to make direction sensitive hardware.

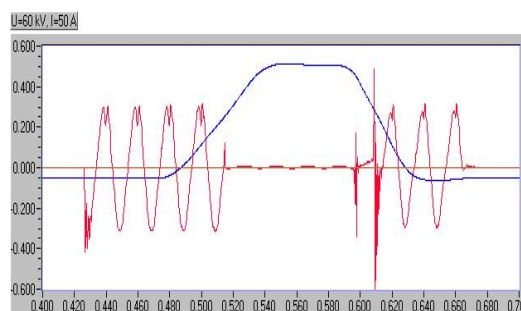

Fig. 3 Laboratory test of circuit breaker at low current (making and breaking)

III. T TRANSFORMER

Transformers are a vital part of the transmission and distribution system. Monitoring transformers online for problems, before they occur, can prevent faults that are costly to repair and result in a loss of service. Very equipment continually monitors the operating condition and changes in performance of transformers and provides information about the state of a transformer. The TR-16 (Fig. 4) is a 16 channel portable Class A power system analyzer[10]. It can be used with various configurations of input signal conditioners for different measurement tasks. It is capable to perform both short or long term monitoring functions or the evaluation of voltages, currents, active and reactive powers, impedances, voltage outages, flicker harmonics on 16 channels simultaneously



Fig. 4 Picture of TR-16 equipment

In this paper for transformer monitoring windings, a simulated model is developed for the transformer winding and the PD phenomenon mechanism. The impulse current test and wavelet packets transformation are used to detect PD. It is shown that the neutral current measurement of the transformer winding has useful information about failure in transformer insulation.

A. Winding High Frequency Model

In the range of frequency associated to PD, the transformer winding behaves as a complex ladder network consisting of inductances, capacitances and conductances. For PD

evaluation, a model is required which describes the physical dimensions of windings as precisely as possible within the acceptable frequency rang. The detailed model shown in Fig. 5 has been used for interpreting the high frequency behavior of transformer coils. The simulation model is an equivalent RLC circuit network based on the theory that should have the same external circuit behavior as the behavior that transformer winding has. For PD localization and evaluation applications, usually it is enough to locate the disk unit of the winding in which PD has occurred. Therefore the number of the RLC units has been chosen equivalent to the number of coil sections. Thus each winding section is considered as a black-box represented by a RLC unit [3-6].

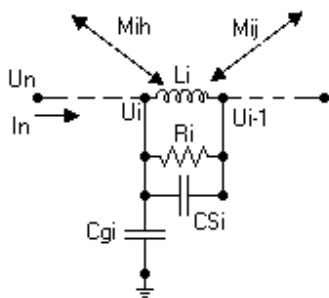

Fig.5 Equivalent circuit of the transformer winding

L_i models the leakage inductance. C_s and C_g represent the coil to coil and coil to ground capacitances respectively. R_i represents the loss due to the insulation between adjacent winding section. The mutual inductances between each winding section and the other ones are modeled by M . This winding model is previously used for 220 kV winding with 28 disk in [11]. The inductive branch current vector,

$$[I] = [i_1 \ i_2 \ \dots \ i_{n+1}]^T \quad (1)$$

and the nodal voltage vector

$$[U] = [v_1 \ v_2 \ \dots \ v_{n+1}]^T \quad (2)$$

are the variable vectors of the model. The winding can be mathematically presented by the following state equation:

$$\begin{bmatrix} U^0 \\ I^0 \end{bmatrix} = \begin{bmatrix} -C^{-1}.G & -C^{-1}.A \\ -M^{-1}.A^T & -R_s.M^{-1} \end{bmatrix} \begin{bmatrix} U \\ I \end{bmatrix} + \begin{bmatrix} C^{-1} & M^{-1} \end{bmatrix} \begin{bmatrix} B_1 \\ B_2 \end{bmatrix} \quad (3)$$

where, M , G , and C are the nodal inductance, nodal conductance, and nodal capacitance matrixes respectively. R_g and A are the series resistance matrix and the incidence matrix of the inductive circuit.

B. Pd Model

Generally, a 3-capacitance model as shown in Fig.6 is used to analyze the PD pulse current that appears at outer electrodes. C_g is the capacitance of the region where the discharge takes place. C_b is the capacitance of the region in series with C_g . C_a is the capacitance of the rest region in the dielectric. Rest region of dielectric (C_a) is the region of insulator that is not infected by PD and also it is not series

with the cavity. When discharge takes place in C_g , the current I_d will be produced in external terminals [6].

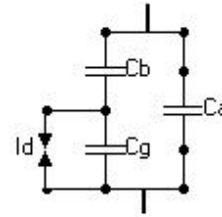

Fig.6. Three-capacitance model of PD

The sentence punctuation follows the brackets [5].

In Fig.6 $C_a \gg C_g > C_b$,

In this model Partial Discharge Inception Voltage (PDIV) can be calculated by the following equation [13-14].

$$PDVI = 26.5 \times p \times t + 0.55 \quad (4)$$

where, p is the pressure in void[atm] and t is the thickness of void [cm].

Fig.6 has been modeled using the EMTP Tools (MODELS, TACS) that show partial discharge mechanism. In this model PDVI can be calculated by equation (4) or it could be determined directly. For simulation of partial discharge in each section of winding, Fig.6 replaces the capacitance of the unit. For testing the safety of PD model, an infected disk considered under sinusoidal voltage is compared with [12]. Fig. 7-a illustrates the voltage of C_g under the sinusoidal voltage. Fig. 7-b shows the current i_d that is generated in external terminals under sinusoidal voltage.

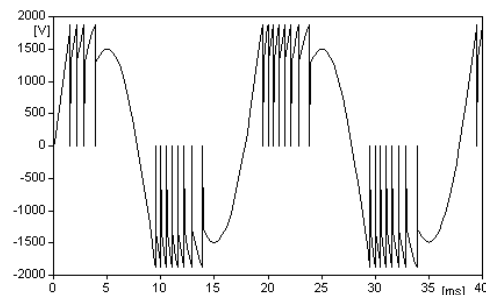

Fig. 7-a Voltage of C_g under sinusoidal voltage

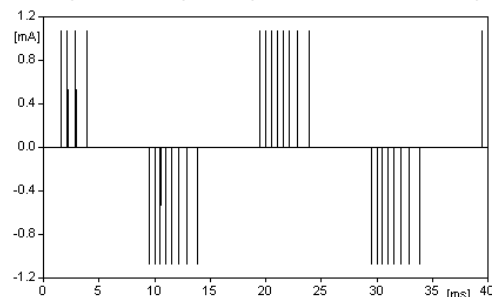

Fig. 7-b Current i_d that act on external terminals under sinusoidal voltage

C. Simulation

Now we are sure that PD models and transformer winding are correct. A steep impulse current (same lightning impulse) is applied to the winding as input signal. The current at the other terminal is measured as output. The current of neutral point is analyzed by wavelet transformation.

For example, the current of neutral point was modeled as shown in Figs 8 to 10 when PD is assumed in disks 1, 10, and 28 respectively.

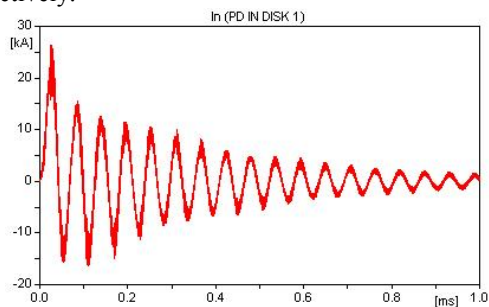

Fig.8: Current of neutral point (disk 1 is infected)

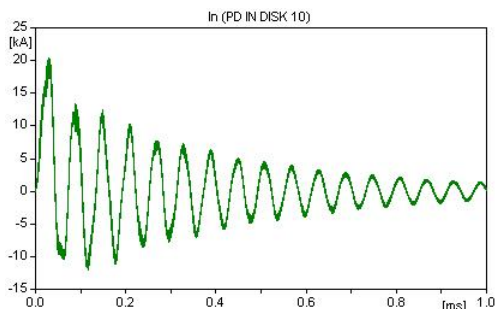

Fig.9: Current of neutral point (disk 10 is infected)

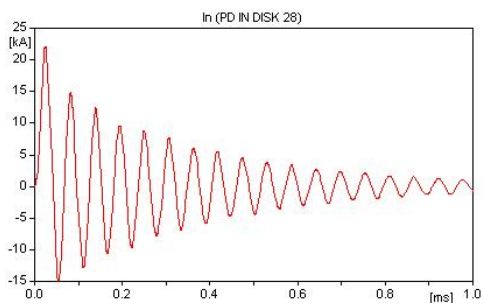

Fig.10: Current of neutral point (disk 28 is infected)

Figs. 8 to 10 were analyzed by the wavelet packets transformation. Details of the first level are shown in Figs 11 to 13.

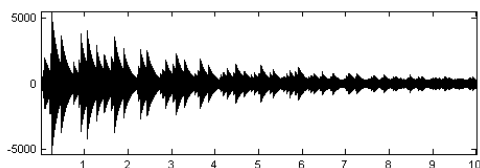

Fig.11: Details of the first level for fig 8

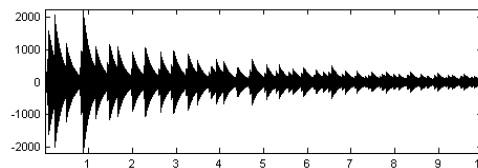

Fig.12 Details of the first level for fig 9

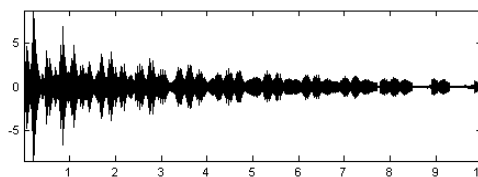

Fig.13 Details of the first level for fig 10

The figs. 11-13 show the high frequency behavior of the signals. It is obvious that the high frequency components of neutral point current are severely affected by the PD location. We save these data (coefficients details of one level for each infected disk) in a database. By comparing the details at first level, PD and any fault could be detect easily.

Fig. 14 shows the result of its comparing with a linear curve. Horizontal axis represents the number of disk and vertical axis represents the peak of details versus dB.

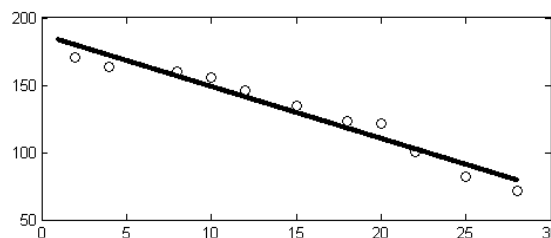

Fig.14: Peak of detail (dB) versus number of disk

Therefore fault in insulation could be detect in transformer winding easily; but in this simulation, we assumed that radius of cavity is 0.5 [mm] and C_b , C_g and C_a were calculated. The radius of cavity could be 1[mm], 2[mm] or other more values or a breakdown can be appear in insulation.

Radius of cavity has no effect on the accuracy of the proposed method. If the radius of cavity is more, the intensity discharge is more and the details of the first level are increased. Thus, identification and monitoring becomes easier. In this method, transient phenomena (e.g. lightning) can be used as input signal and only the neutral point current registration is enough for insulation monitoring of transformers.

IV. CONCLUSION

In this paper, using the EMTP tools partial discharge and detailed model of transformer winding is simulated. An impulse current has been applied to winding and the current of neutral point of winding was analyzed by wavelet packet. The proposed method can determine insulation failure in any winding or power apparatus and can be used for insulation monitoring in transformer or other power apparatus. In this

method, transient phenomena can be used as an input signal. So, transformer can be monitored easily.

Also, at circuit breakers the displacement- time function represents the mechanical state. If a swing begins to develop actions have to be made to avoid the blowing up of the circuit breaker.

REFERENCES

- [1] E.P.Dick, C.C Erven, "Transformer diagnostic testing by frequency response analysis", IEEE Trans. Power Appl. Syst., 1978, PAS-97,vol.6, pp. 2144-2153
- [2] J.Lapworth, T.Mcgrail, "Transformer winding movement detection by frequency response analysis". Proc. 66th Annual Int. Conf. Doble Clients, Boston, MA, April 1999
- [3] G.Mcdowell, L.Lockwood, "Real time monitoring of movement of transformer winding", IEE Colloquium on Condition monitoring and remanent life assessment in power transformers, 1994, pp. 1-14
- [4] .Z.D.Wang,P.A.Crossley,K.J.Cornik,D.H.Zho, "An Algorithm for Partial Discharge Location in Distribution Power Transformer",IEEE Power Engineering Society Winter Meeting, Jan 2000.
- [5] S. M.Islam , G. Ledwich, " Locating Transformer Faults Through Sensitivity Analysis of High Frequency Modeling Using Transfer Function Approach" Conference Record of the IEEE International Symposium on Electrical Insulation,Montreal, Quebec,Canada,June 16-19,1996
- [6] J.Gui,W.Gao, K.Tan, Sh.Gao, "Locating Partial Discharge in Power Transformer by Electrical Method" Proceeding of the 7th International Conference on Properties and Application of Dielectric Materials .June 1-5,2003, Nagoya
- [7] P. L.Timár., A. Fazekas., L .Kiss.," Villamos gépek zaja és rezgése. Műszaki Könyvkiadó" Budapest, 1968.
- [8] L. Tóth, T. Tóth, "Short-circuit tests on power transformers with pressure measurements," Powertech 99, Budapest
- [9] RST Ltd, Transanal-16 user's manual, Budapest, 2001
- [10] G.B. Gharehpetian, H. Mohseni ,K. Moeller, "Hybrid Modeling of Inhomogeneous Transformer Windings for Very Fast Transient Overvoltage Studies", IEEE Trans. on Power Delivery, Vol. 13, No. 1, Jan. 1998, pp. 157-163.
- [11] P .Nikolay.Kolev, Micheal G.Danikas, Elissaveta D.Gadjeva, Nikolay R.Gourov, "Development of Partial Discharge Model, Simulation and Measurement", 1999 Conference on Electrical Insulation and Dielectric Phenomena, Vol.1, p.p: 214 - 217
- [12] S.I. Jeon , D. Sung Shin , D.H.Yun , K. M. Han , M.Koo. Han. "A study on the partial discharge characteristics according to distribution pattern of voids within an insulation" , 5th International Conference on Conduction and Breakdown in Solid Dielectrics, p.p: 398 - 402 ,995
- [13] F.Chunju, K.K. Li, W.L. Chan, Y.Weiyong, Z.Zhaoning," Application of wavelet fuzzy neural network in locating single line to ground fault (SLG) in distribution lines," International Journal of Electrical Power & Energy Systems, Vol.29, Issue 6,pp: 497-503, 2007