

# Acoustic Noise Reduction in Single Phase SRM Drives by Random Switching Technique

Minh-Khai Nguyen, Young-Gook Jung, and Young-Cheol Lim

**Abstract**—It is known that if harmonic spectra are decreased, then acoustic noise also decreased. Hence, this paper deals with a new random switching strategy using DSP TMS320F2812 to decrease the harmonics spectra of single phase switched reluctance motor. The proposed method which combines random turn-on, turn-off angle technique and random pulse width modulation technique is shown. A harmonic spread factor (HSF) is used to evaluate the random modulation scheme. In order to confirm the effectiveness of the new method, the experimental results show that the harmonic intensity of output voltage for the proposed method is better than that for conventional methods.

**Keywords**—Single phase switched reluctance motor (SRM), harmonic spread factor (HSF), random switching technique.

## I. INTRODUCTION

ONE of the possible electrical machines in variable-speed and servo drives is a switched reluctance motor. The SRM has certain advantages, such as simple construction, low manufacturing cost, rugged construction, fault-tolerant operation, high efficiency, high reliability and robustness in operation, which have attracted researchers to this machine. However, there are several disadvantages of this machine. The disadvantages of the SRM are the emitted acoustic noise, the higher torque ripple, and vibration compared to other motors. The origin of the emitted acoustic noise in SRM is due to triggering mechanical resonances. It has been shown that the dominant source of the vibration and the acoustic noise in the SRM is radial vibrations of the stator [1], [2]. These vibrations are caused by radial magnetic force, which act to decrease the gap separation between the rotor and stator as their poles approach alignment.

Recently, several works have been done to characterize the SRM acoustic noise as shown in [3]-[5]. Unfortunately, only a few control approaches are presented to lower SRM acoustic noise. In [3], a presented method is randomly varying the turn-on and turn-off angle within  $1^\circ$ - $3^\circ$  which is useful in the whole operating area of the SRM. However, this method only gives a low reduction in the acoustic noise emission. Another method is to use a switching frequency higher than 18 kHz but it

has the drawback of high switching losses in power inverters. A recent method to reduce acoustic noise is to use random pulse width modulation (PWM) technique that is useful for induction motor [6], [7].

In the paper, we deal with a simple and effective method using random modulated strategy and random PWM technique for a 6/6 SRM. This technique plays an essential role in a significant reduction acoustic noise by combining the varying turn-on, turn-off angle and random PWM scheme. While target of random turn-on, turn-off angle technique is to decrease amplitude of the fundamental harmonics, random PWM technique is to provide harmonic spectra intensity flatter than that obtained by conventional method. This combination will help avoiding the triggering mechanical resonances. Thus, the harmonic spectra of output voltage in SRM are reduced significantly. The experimental results obtained from a laboratory system show that the harmonic intensity of output voltage for the proposed method is better than that for conventional methods.

## II. ACOUSTIC NOISE

The conventional SRM drive has a higher noise level than conventional motors. There are many possible sources of acoustic noise in a doubly salient SRM. The possible noise sources in SRM are the following [1], [2]:

- There is a strong radial magnetic attraction between the stator and the rotor of the SRM because of the doubly salient structure. This attraction could excite stator vibrations, which would emit acoustic noise. The radial force  $F_r$  can be expressed by

$$F_r(\theta, lg, t) = -\frac{1}{2}i(t)^2 \frac{L(\theta(t), i(t), lg)}{lg} \quad (1)$$

where  $\theta$  is the rotor position;  $lg$  is the minimum airgap between the stator and the rotor at the aligned position;  $L$  is the self-inductance of the winding; and  $i$  is the winding current.

- Under many conventional control algorithms, the doubly salient SRM exhibits considerable torque ripple which could emit acoustic noise.
- Winding vibration produced by the interaction in the stator windings with local magnetic field is also a source of noise.

M. K. Nguyen is with the Electrical Engineering, Chonnam National University, Gwangju, 500-757 KOREA (e-mail: khaibk@yahoo.com).

Y. G. Jung is with the Electrical Engineering, Darbul University, Chonnam, 526-890 KOREA (e-mail: jyg@mail.daebul.ac.kr).

Y. C. Lim is with the Electrical Engineering, Chonnam National University, Gwangju, 500-757 KOREA.

- The laminations in the SRM experience magnetostrictive forces. The vibration in all parts of the magnetic material caused by this force also produces noise.
- Faulty bearings and other mechanical defects also lead to noisy vibration.

### III. CONVENTIONAL AND PROPOSED METHODS

In SRM the turn-on angle and turn-off angle can be controlled as well as the duty-cycle [3]. The duty-cycle is normally controlled at low speed in order to reduce the current flow in the SRM. At higher speed the current is limited by the back-emf and there is no need for using different duty-cycles. Instead the turn-on and turn-off angles are controlled. Several methods have been proposed to reduce the acoustic noise in SRM by modulation technique. The first method is to vary the switching frequency randomly. The second one is to change between lagging edge and leading edge modulation. The other method is randomly to vary the turn-on angle  $\alpha_{on}$  and turn-off angle  $\alpha_{off}$  within  $1^\circ$ - $3^\circ$  as shown in [3]. However, those methods only give a small reduction in the acoustic noise emission. The proposed method is a combination of the random PWM scheme and varying turn-on and turn-off angle. This combination will help avoiding the triggering mechanical resonances. Thus, the acoustic noise in SRM will be reduced significantly.

Fig. 1 shows an inductance profile (top) and output voltage (bottom) for a combination of the random PWM technique and varying turn-on, turn-off angle. Fig. 2 shows the practical cases for combination of random the turn-on/off angle and RPWM. In Fig. 2 the mode 1, 2, 3 and 4 are practical cases for random the turn-on angle  $\alpha_{on}$  and turn-off angle  $\alpha_{off}$ ; the angle  $\alpha_0$  is the angle where the rotor and stator pole starts overlapping physically;  $\alpha_a$  is the aligned angle where the rotor is totally overlapped by the stator;  $\alpha_{adv}$  is the advance angle ( $\alpha_{adv}$  is positive if  $\alpha_{on}$  is smaller than  $\alpha_0$  and conversely  $\alpha_{adv}$  is negative);  $\Delta\alpha_{(1, 2, 3)}$  is the total conduction angle ( $\alpha=0^\circ$  is when the rotor and stator are completely unaligned);  $\Delta\alpha_r$  is an interval for turn-on, turn-off angle control; and  $r$  is the random angle value from  $0^\circ$  to  $2^\circ$ . The random strategy is a combination of the random PWM technique and varying the turn-on angle  $\alpha_{on}$ , turn-off angle  $\alpha_{off}$  randomly according to  $\alpha_0$  and  $\alpha_a$  within  $\Delta\alpha_r$  from  $0^\circ$  to  $2^\circ$  while  $\Delta\alpha$  is kept constant. The advantage of this new method is to reduce acoustic noise in SRM significantly

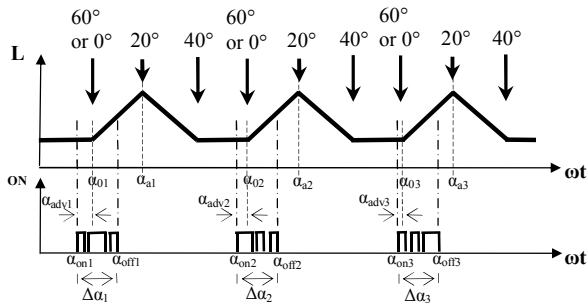

$$\begin{aligned} \alpha_{adv1} &\neq \alpha_{adv2} \neq \alpha_{adv3} \\ \Delta\alpha_1 &= \Delta\alpha_2 = \Delta\alpha_3 = 20^\circ \\ x^\circ - |\Delta\alpha_r| &\leq \alpha_{on(1,2,3)} \leq x^\circ + |\Delta\alpha_r| \\ \alpha_{off(1,2,3)} &= \alpha_{on(1,2,3)} + \Delta\alpha_{(1,2,3)} \\ |\Delta\alpha_r| &\leq 2^\circ \end{aligned}$$

Fig. 1 The proposed method

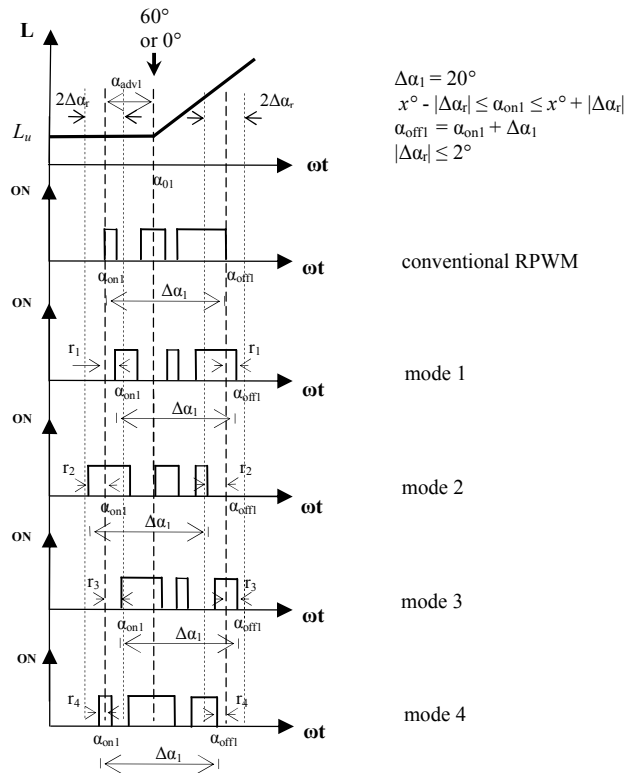

Fig. 2 Practical cases for combination of random the turn-on/off angle and RPWM.

A random number generator is generated by Linear Congruential Generator (LCG) algorithm [6] using random pulse position (RPP) scheme. A positive integer random number  $f_{ran}$  within the range  $[0, i_m]$  can be generated by,

$$f_{ran+1} = (f_{ran} \cdot i_a + i_c) \% i_m \quad (2)$$

where % in the modulus function. And a floating point random number  $ran$  ranged 0 to 1 is generated by,

$$ran = (float)f_{ran} / (float)i_m \quad (3)$$

In (6)-(7),  $i_w$ ,  $i_c$  and  $i_m$  are the selected coefficients and called the multiplier, increment and modulus, respectively.

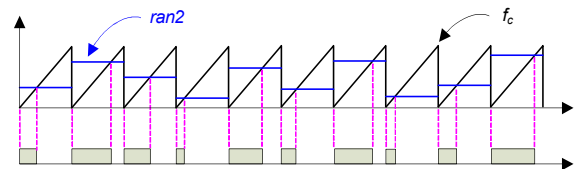

Fig. 3 The procedure of RPP generation

The control system requires two separate random number generators:  $ran1$  and  $ran2$ . The  $ran1$  is used to generate the random turn-on angle. The  $ran2$  is used to generate the random PWM. Fig. 3 shows the procedure of random pulse position

(RPP) generation. An asymmetric carrier ( $f_c$ ) with 1 amplitude at 6 kHz is used to compare with  $ran2$  value from 0 to 1.

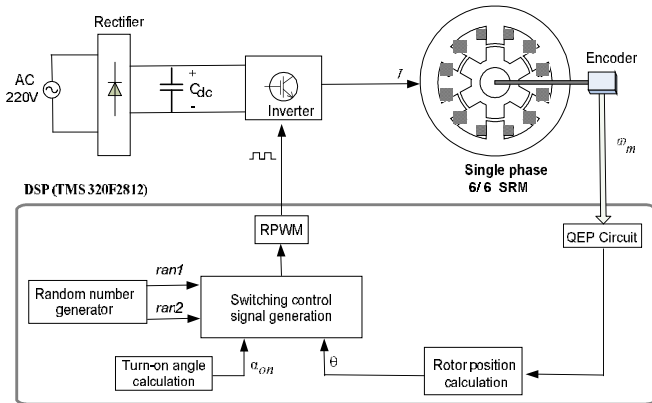

Fig. 4 Block diagram of SRM drive system.

Fig. 4 shows the block of SRM drive system. As shown in Fig. 4, the rotor position  $\theta$  is calculated by the encoder through the rotor position calculation block;  $ran1$ ,  $ran2$  are generated by random number generator block; the reference turn-on angle  $\alpha_{on}$  is can be estimated by

$$\alpha_{on} = -\frac{L_u I^* \omega_r}{V_{dc}} \quad (4)$$

where  $L_u$  is the inductance in unaligned position as shown in Fig. 2;  $I^*$  is the reference current obtained from speed controller;  $V_{dc}$  is DC bus voltage;  $\omega_r$  is motor speed ( $\alpha = 0^\circ$  is when the rotor and stator are completely unaligned).

And the turn-off angle is set based on the following formula,

$$\alpha_{off} = \alpha_{on} + 20^\circ \quad (5)$$

#### IV. EXPERIMENTAL RESULTS

The overall experimental system is illustrated in Fig. 4, and it includes a TMS320F2812 DSP controller, a voltage source IGBT inverter and the single-phase 6/6 SRM shown in Fig. 5. The DC bus voltage is 30V. The interval  $\Delta\alpha_r$  is 3 degree. And the switching frequency ( $f_{sw}$ ) is 6 kHz. The inverter has two IGBT type power transistors and two power diodes. Input signals of the inverter are random PWM signals from DSP chip.

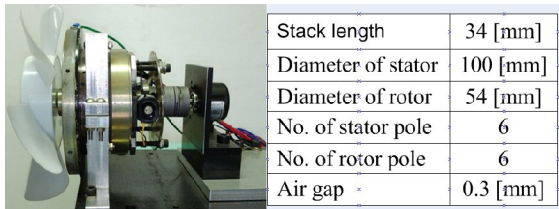
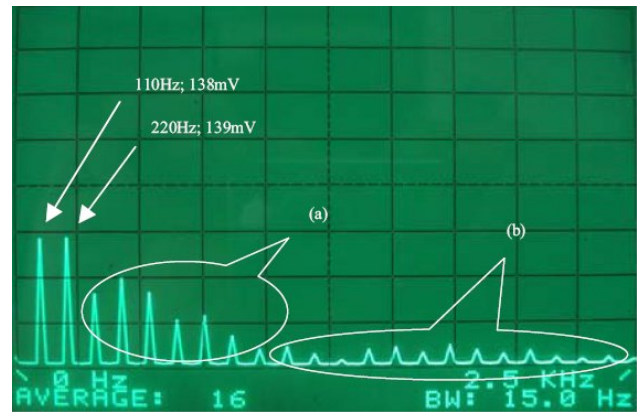

Fig. 5 Single-phase 6/6 SRM for experimentation

To fully explore the merits of the new method, a power spectra of the motor voltage for proposed method is compared by that for conventional methods. The two conventional methods are using PWM technique with fixed turn-on/turn-off

angle and random PWM technique with fixed turn-on/turn-off angle, respectively. Fig. 6 shows power spectra of the motor voltage. As shown in Fig. 6a for conventional method, the amplitude of the all components is more dominant than that as shown in Fig. 6c for the proposed method. Sub-harmonics in area (a) of figure 6c are smaller than these of figure 6a and 6b. In addition, in Fig. 6c for the proposed method, the dominant components in area (b) are more flat than that obtained by conventional method.



a) Conventional method with chopping mode

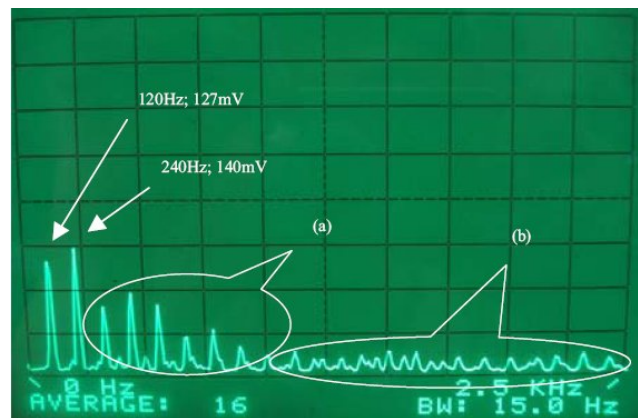

b) Conventional method with RPWM technique

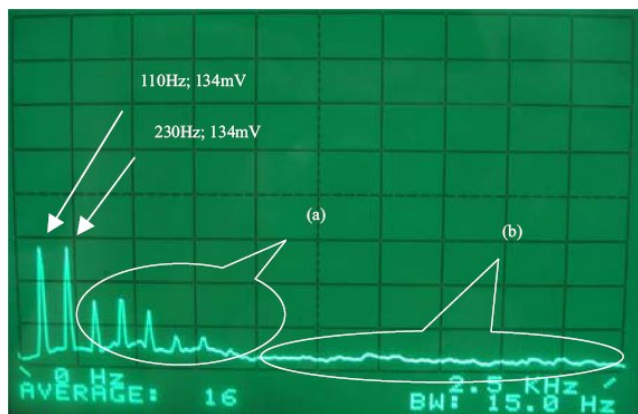

c) The proposed method ( $\Delta\alpha_r = 2^\circ$ )

Fig. 6 Measured results of the output voltage spectra at 1000 rpm,  $f_{sw} = 6$  kHz, frequency span 0 – 2.5 kHz (x-axis: 250Hz/div.; y-axis: 50mV/div.)

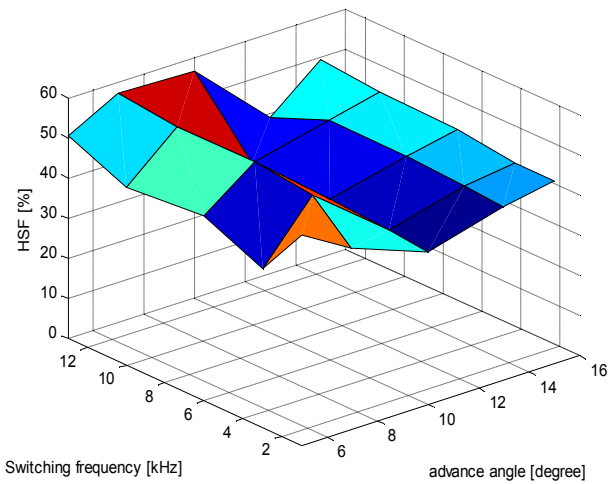

a) Conventional method with chopping mode

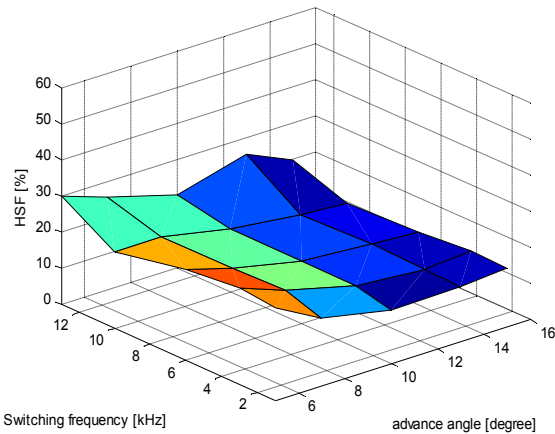

b) Conventional method with RPWM technique

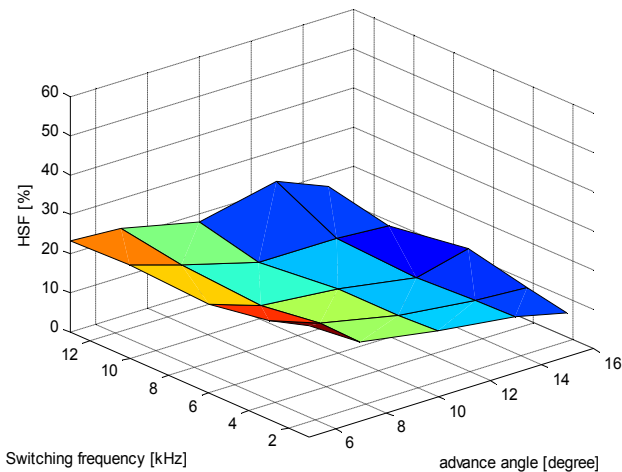

c) The proposed method ( $\Delta\alpha_r = 2^\circ$ )

Fig. 7 The HSF for different switching frequency and advance angle

Furthermore, for evaluating the random PWM technique, a simple indicator of quality of voltage spectrum would be useful. For this purpose, the concept of statistical deviation can be

employed and the Harmonics Spread Factor (HSF) [7], [8] is defined as,

$$HSF = \sqrt{\frac{1}{N} \sum_{j>1}^N (H_j - H_0)^2} \quad (6)$$

where N denotes the total number of frequency components considered,  $H_j$  is the amplitude of the  $j^{\text{th}}$  component, and  $H_0$  is the average value of all components and given by,

$$H_0 = \frac{1}{N} \sum_{j>1}^N H_j \quad (7)$$

The HSF quantifies the spread spectra effect of random PWM and it should be possibly small. For ideally flat spectra of white noise, the HSF would be zero.

Table 1 gives the output voltage HSF for various PWM schemes. The HSF of the proposed method reaches at 16.29% lower than those (18.31%) of the conventional methods. The random PWM control and the random turn on-off angle control in the proposed method can be easily combined by C-language program. Therefore, a two percentage HSF improvement is quite worthwhile for the additional efforts. For proposed method, Table 2 gives the output voltage HSF for various  $\Delta\alpha_r$ . Fig. 7 shows voltage spectra in the whole operation area of the 6/6 SRM for different switching frequency. In comparing these results, we can observe that the harmonic spectra are reduced significantly when using random modulation. It is clear that, as expected, the proposed strategy results in a significant improvement in the acoustic noise reduction relative to other strategies.

TABLE I  
 COMPARISONS OF HSF FOR VARIOUS SWITCHING FREQUENCY

PWM types	Fixed chopping mode	Conventional RPWM	Proposed method ( $\Delta\alpha_r = 2^\circ$ )
HSF [%]	40.03	18.31	16.29

TABLE II  
 COMPARISONS OF HSF FOR VARIOUS  $\Delta\alpha_r$  OF THE PROPOSED METHOD

$\Delta\alpha_r$ (degree)	1	1.5	2	2.3	3
HSF (%)	17.13	15.92	16.29	17.74	17.07

## V. CONCLUSIONS

This paper has discussed the implementation techniques for various random PWM and random turn-on, turn-off angle strategies in single-phase 6/6 SRM. While target of random turn-on, turn-off angle technique is to decrease amplitude of the fundamental harmonics, random PWM technique is to provide harmonic spectra intensity flatter than that obtained by conventional method. The HSF is used to evaluate the random PWM technique. The experimental results confirm that the new

proposed method provide better harmonic spectra performance than conventional strategies in spreading the harmonic power over a wide frequency range. This method can be applied for all SRMs including three-phase or two-phase without the modification of a certain parameters.

#### ACKNOWLEDGMENT

This work was supported by the Research Center for Nano-Energy Materials at Chonnam National University in KOREA.

#### REFERENCES

- [1] D. E. Cameron, J. H. Lang, and S. D. Umans, "The origin and reduction of acoustic noise in doubly salient variable-reluctance motors," *IEEE Trans. Ind. Applicat.*, 1992, pp. 1250-1255.
- [2] D. E. Cameron, J. H. Lang, and S. D. Umans, "The origin of acoustic noise in variable-reluctance motors," *IEEE Industry Applications Society, IAS'89*, 1989, pp. 89-98.
- [3] F. Blaabjerg, and J. K. Pedersen, "Digital implemented random modulation strategies for ac and switched reluctance drives," *The Annual Conference of the IEEE Industrial Electronics Society, IECON'93*, 1993, pp.676-682.
- [4] C. Pollock, and C. Y. Wu, "Acoustic noise cancellation technique for switched reluctance drives," *IEEE Trans. Ind. Applicat.*, Mar./Apr. 1997, pp. 477-484.
- [5] B. Fahimi, G. Suresh, K. M. Rahman, and M. Ehsani, "Mitigation of acoustic noise and vibration in switched reluctance motor drive using neural network based current profiling," in *Conf. Rec. IEEE-ISA Annu. Meeting*, 1998, pp.715-722.
- [6] Y. G. Jung, S. H. Na, Y. C. Lim, and S. H. Yang, "Reduction of audible switching noise in induction motor drives using random position PWM," *IEE Proc. Electr. Power Appl*, May 2002, pp.195-202.
- [7] K. S. Kim, Y. G. Jung, and Y. C. Lim, "Shaping the spectra of the acoustic noise emitted by three-phase inverter drivers based on the new hybrid random PWM technique," in *Conf. Rec. of IEEE Power Electronics Specialist Conference, PESC'06*, 2006, pp.545-550.
- [8] R. L. Kirlin, M. M. Bech, A. M. Trzynadlowski, and B. Huo, "Power and power spectral density in pwm inverters with randomized switching frequency," *IEEE Power Electronics Specialist Conference, PESC'01*, 2001, pp. 188-192.