

Detection of Power Quality Disturbances using Wavelet Transform

Sudipta Nath, Arindam Dey and Abhijit Chakrabarti

Abstract—This paper presents features that characterize power quality disturbances from recorded voltage waveforms using wavelet transform. The discrete wavelet transform has been used to detect and analyze power quality disturbances. The disturbances of interest include sag, swell, outage and transient. A power system network has been simulated by Electromagnetic Transients Program. Voltage waveforms at strategic points have been obtained for analysis, which includes different power quality disturbances. Then wavelet has been chosen to perform feature extraction. The outputs of the feature extraction are the wavelet coefficients representing the power quality disturbance signal. Wavelet coefficients at different levels reveal the time localizing information about the variation of the signal.

Keywords—Power quality, detection of disturbance, wavelet transform, multiresolution signal decomposition.

I. INTRODUCTION

THE increased requirements on supervision, control and performance in modern power systems make power quality monitoring a common practice for utilities. Studies of power quality phenomena have emerged as an important subject in recent years due to renewed interest in improving the quality of the electric supply. As sensitive electronic equipment continues to proliferate the studies of power quality will be further emphasized. New tools are required to extract all relevant information from the recordings in an automatic way.

The wavelet transform is a mathematical tool like Fourier Transform in analyzing a signal that decomposes a signal into different scales with different levels of resolution. Santoso et al [1] proposed wavelet transform technique for the detection and localization of the actual power quality disturbances. They explored the potential of wavelet transform as a new tool for automatically classifying power quality disturbances. Heydt

The authors acknowledge the financial support given by SERC, DST, Govt. of India, for sponsoring this research in the form of grant-in-aid to Dr. Sudipta Nath, Assistant Professor, Department of Electrical Engineering, Netaji Subhash Engineering College, Kolkata.

Sudipta Nath is with Department of Electrical Engineering, Netaji Subhash Engineering College, Kolkata. West Bengal, India. (e-mail: nath_sudipta@yahoo.com).

Arindam Dey was M. Tech. student under Dr. Sudipta Nath, Netaji Subhash Engineering College, Kolkata. West Bengal, India.

Abhijit Chakrabarti is with the Electrical Engineering Department, Bengal Engineering and Science University, Shibpur, Howrah 711103, India. (e-mail: a_chakrabarti55@yahoo.com).

and Galli [2] proposed wavelet techniques for the identification of the power system transient signals. Fuzzy logic control technique has been discussed by Hiyama et al [3] to enhance power system stability using static VAR compensator. The proposed control scheme is simple and suitable for on-line implementation using a microcontroller. Santoso et al [4] combined wavelet transform with Fourier transform for the characterization of the power quality events. The Fourier transform has been used to characterize steady state phenomena, whereas the wavelet transform has been applied to transient phenomena. A hybrid scheme using a Fourier linear combiner and a fuzzy expert system for the classification of transient disturbance waveforms in a power system has been presented by Dash et al [5]. Olivier et al [6] investigated the use of a continuous wavelet transform to detect and analyze voltage sags and transients. They developed an efficient and simple algorithm for detecting and measuring power quality analysis. A digital signal processing architecture capable of simultaneous and automated detection and classification of transient signals has been developed by Angrisani et al [7]. The basic unit of the architecture is the wavelet network which combines the ability of the wavelet transform for analyzing non stationary signals with the classification capability of artificial neural networks. Styvaktakis et al [8] developed an expert system to classify different types of power system events and offer useful information in terms of power quality. Huang et al [9] presented a neural-fuzzy technology based classifier for the recognition of power quality disturbances. The proposed recognition system provides a promising approach applicable in power quality monitoring. Driesen and Belmans [10] proposed further alternatives for power quantification based on formulations and time frequency domain described by wavelet bases. They used both the real and complex valued wavelets. He and Starzyk [11] proposed a novel approach for power quality disturbances classification based on wavelet transform and self organizing learning array system. Wavelet transform has been utilized here to extract feature vectors for various power quality disturbances based on multi resolution analysis. Lin and Wang [12] proposed another model for power quality detection for power system disturbances using adaptive wavelet networks. Megahed [13] et al presented a new method for the boundary protection and fault classification of series compensated transmission lines using discrete wavelet transform. An effective algorithm for arcing fault detection for distribution network with the application of wavelet transform technique has been presented by Michalik et al [14]. Ibrahim

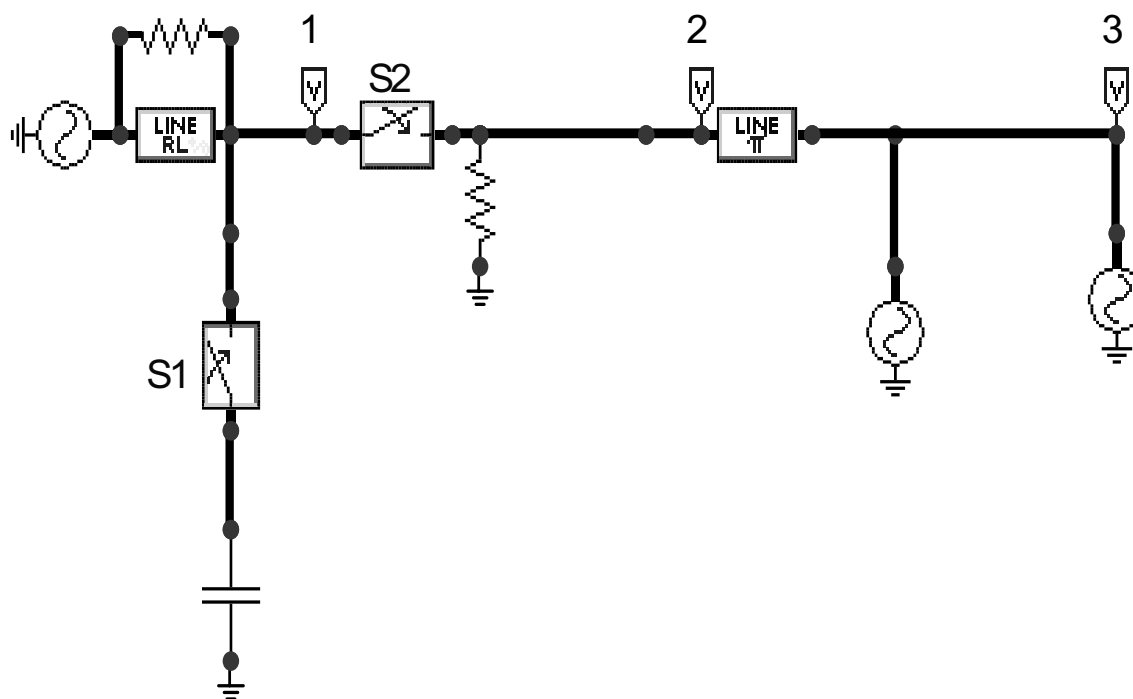

Fig. 1 System configuration of the model used for testing

Open Science Index, Electrical and Computer Engineering Vol:3, No:1, 2009 publications.waset.org/4101.pdf

and Morcos [15] introduced the details of an intelligent adaptive fuzzy system which can be installed to monitor electrical equipment or system. Tarasuik [16] deals with the detection and evaluation of different kinds of waveform distortions such as harmonics, inter harmonics, transients and notching using hybrid-fourier method. Hong and Chen [17] presented a new method to locate the positions of the switching capacitors using discrete wavelet transform. Valsan and Swarup [18] proposed a novel wavelet transform based directional algorithm for bus bar protection. Brahma [19] introduces wavelet transform to reliably and quickly detect any fault during a power swing. A logic block based on the wavelet transform has been developed. Another expert system developed by Reaz et al [20] which employs a different type of univariate randomly optimized neural network combined with discrete wavelet transform and fuzzy logic to have better power quality disturbance classification accuracy. The need to analyze power quality signals to extract their distinctive features made Gargoom et al [21] to use Hilbert transform and Clarke transform for the classification of power quality signals and compared the performance of these techniques with wavelet transform. Elkalashy et al [22] used DWTs to detect high impedance faults due to leaning trees. Wireless sensors have been considered for processing the DWTs. Mishra et al [23] presented an S transform based probabilistic neural network classifier for the recognition of power quality disturbances.

The Wavelet Transform is a powerful tool for detection of power quality problems. This paper deals with the use of

discrete wavelet transform to detect and analyze voltage sag, swell, outage and transients.

II. POWER SYSTEM NETWORK SIMULATION

Computer simulated waveforms for various transient disturbances of a power system are generated using EMTP software package. The example taken for study is shown in Fig. 1. This circuit is mainly designed to detect voltage disturbances in a system. The circuit consists of three ac voltage sources. The first source having rating of 10KV is supplying power to the network throughout the entire period under consideration. The next source having rating of 1 KV is operated only from 0.1 s to 0.5 s. The third source of 10KV is operated from 0.2 s to 0.7 s. The network comprises transmission line section, resistances and capacitor bank. The resistance in parallel to the transmission line is 200 ohms. A capacitor bank of net capacitance 2.51 μ F is connected through a switch S_1 .

The switch S_1 is closed at 0.5 s and the switch S_2 is closed at 0.1 s. The resistance connected to the ground is of 10 M ohm. The voltage signals at points 1, 2 and 3 are considered for analysis. Fig. 2 and 3 shows the transient response of the voltage waveform at point 2 and point 3 respectively obtained using EMTP. Fig. 4 presents the transient response of the voltage waveform of another phase at point 3.

These waveforms in Fig. 2, Fig. 3 and Fig. 4 contain power quality disturbances like sag, swell, outage and transient. These three signals have been analyzed by wavelet transform to detect the power quality disturbances.

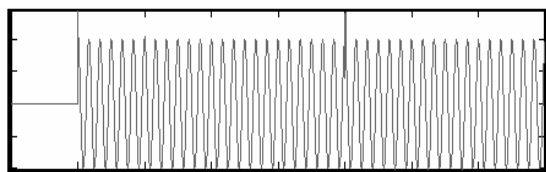

Fig. 2 Voltage signal of phase A at point 2

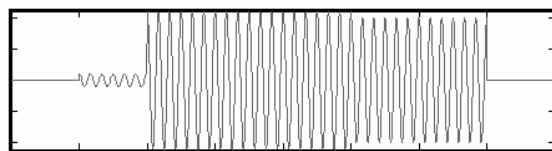

Fig. 3 Voltage signal of phase A at point 3

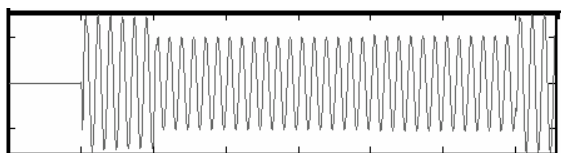

Fig. 4 Voltage signal of phase B at point 3

III. DETECTION AND LOCALIZATION OF DISTURBANCES

This paper presents multiresolution signal decomposition technique as a powerful tool for detecting and classifying disturbances in the electrical distribution system. The proposed technique will deal with the problem not only in time domain or frequency domain, but in a wavelet domain which covers both the time and frequency domains. Multiresolution signal decomposition technique can detect and diagnose defects and provide early warning of impending power quality problems. Using the properties of the wavelet and the features in the decomposed waveform one will have the ability to extract important information from the distorted signal at different resolution levels and classify the types of disturbance.

Here we will analyze signals of Fig. 2, Fig. 3 and Fig. 4 with Discrete Wavelet Transform (DWT). Fig. 5 shows the analysis of the signal in Fig. 2 by wavelet Db4. As far as the detection and the localization are concerned the first inner decomposition level of the signal (d_1) is normally adequate to detect and localize any disturbance in the signal. However other coarser resolution levels are used to extract more features which can help in the classification process. There are few wavelet transform coefficients with high values while the rest has zero value.

The wavelet transform coefficients with high values indicate the power quality disturbance events and the exact location of the disturbance. The other part of the decomposed signal of detail d_1 is smooth indicating that the signal follows some regular patterns in those periods without having any

electrical noise. Detail d_1 shows the exact location of the disturbance. The approximation a_4 reveals the regular pattern of the signal.

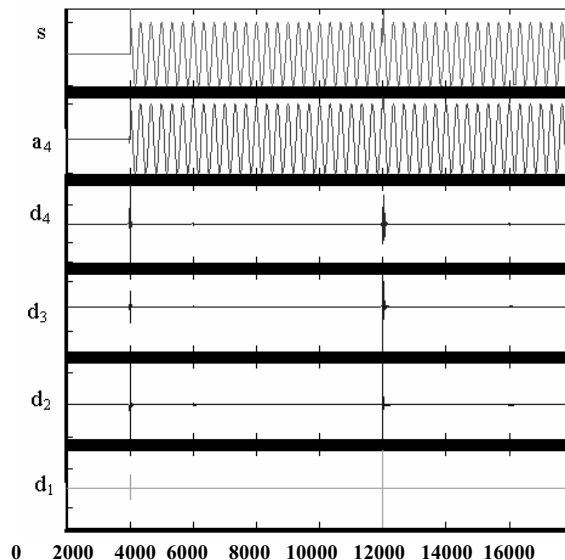

Fig. 5 DWT of the signal in Fig. 2

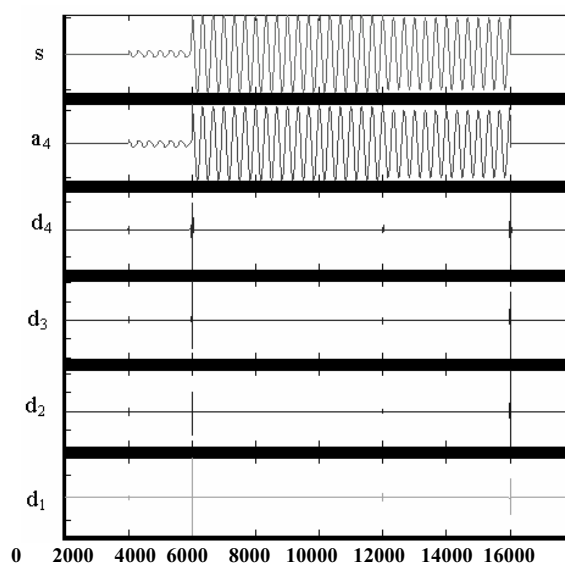

Fig. 6 DWT of the signal in Fig. 3

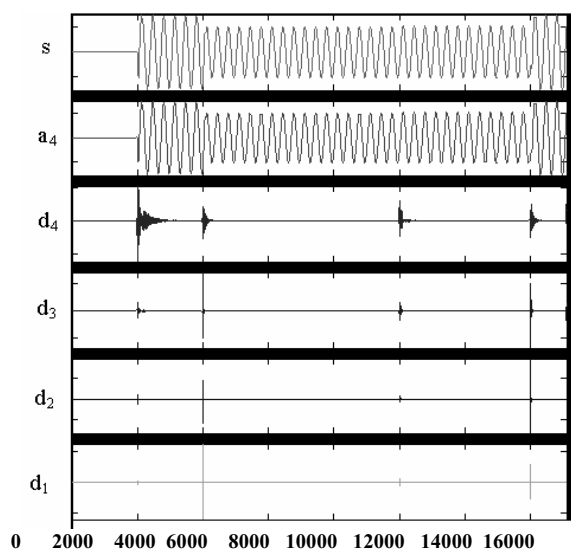

Fig. 7 DWT of the signal in Fig. 4

The decomposition of the signal of Fig. 3 is shown in Fig. 6. The coefficient line in detail d_1 shows the exact location of the initiation of the disturbance. The magnitude of the coefficient line indicates the nature of the disturbance. For example coefficient line at scale 2000 is very small indicating that the change of the magnitude of the waveform before and after that instant is small. This is because there is outage from 0 to 2000 and from 2000 the voltage is of very small amplitude which is sag in nature. Again at 4000 the coefficient value is of large magnitude as there is a drastic change in the voltage amplitude at 4000. At 4000 the voltage becomes normal from its stage of sag. At 10,000 there is slight drop in the amplitude of the voltage waveform and hence the coefficient line at 10,000 is of small magnitude. From 14000 onwards the voltage suddenly decreases to zero and hence the coefficient line at that point is of considerable amplitude. Fig. 7 shows the DWT of the signal shown in Fig. 4. The signal contains voltage sag and outage. The details from level 1 to 4 are shown and the instant of the occurrence of the disturbance can easily be detected from the Wavelet analysis.

IV. CONCLUSION

Nowadays the detection and classification of transient phenomena in the power supply lines are of ever growing importance. Correct detection of undesired transient disturbances is essential for electrical utilities. It is also important for customers principally in verifying that the received power is above the level of quality defined by the service contract.

The currently available measurement equipment which are capable of collecting large amounts of data from the monitored power signals, provides the possibility of detecting only those transient disturbances that cause the rms value of these signals to exceed a fixed threshold. A simple report giving details on disturbance statistics is normally available to the user at the end of the recording. Only very sophisticated instruments can classify the detected transient disturbances on

the basis of their duration as well as estimated amplitude. No automated classification depending on their shape is allowed. Hence power quality engineers can only visually inspect the records in order to select the disturbances and to perform a proper classification. Unfortunately the volume of the collected data is so large that the visual inspection becomes impractical and disturbance detection methods are in considerable demand.

The Wavelet Transform for feature extraction of power disturbance signal is a powerful tool for detection of power quality problems. It has been discussed in detail in the paper the application of Discrete Wavelet Transform for the detection of power quality disturbances.

V. ACKNOWLEDGMENT

The authors acknowledge the financial support given by Department of Science and Technology (DST), Govt. of India for sponsoring this research in the form of grant-in-aid to SERC Young Scientist Project under Dr. Sudipta Nath.

REFERENCES

- [1] S. Santoso, E. J. Powers, W. M. Grady and P. Hofmann, "Power quality assessment via wavelet transform analysis", IEEE Trans. Power Delivery, vol. 11, no. 2, pp. 924-930, Apr. 1996.
- [2] G.T. Heydt and A.W. Galli, "Transient power quality problems analyzed using wavelets", IEEE Trans. Power Delivery, vol. 12, no. 2, pp. 908-915, Apr. 1997.
- [3] T. Hiyama, W. Hubbi and T.H. Ortmeier, "Fuzzy logic control scheme with variable gain for static VAR compensator to enhance power system stability", IEEE Trans. on Power Systems, vol. 14, no. 1, pp. 186-191, February 1999.
- [4] S. Santoso, W. M. Grady, E. J. Powers, J. Lamoree and S. C. Bhatt, "Characterization of distribution power quality events with fourier and wavelet transforms", IEEE Trans. Power Delivery, vol. 15, no. 1, pp. 247-254, Jan. 2000.
- [5] P.K. dash, S. Mishra, M.M. A. Salama and A.C. Liew, "Classification of power system disturbances using a fuzzy expert system and a fourier linear combiner" IEEE Trans. Power Delivery, vol. 15, no. 2, pp. 472-477, Apr. 2000.
- [6] O. Poisson, P. Rioual and M. Meunier, "Detection and measurement of power quality disturbances using wavelet transform" IEEE Trans. Power Delivery, vol. 15, no. 3, pp. 1039-1044, July 2000.
- [7] L. Angrisani, P. Daponte and Massimo D. Apuzzo, "Wavelet network based detection and classification of transients" IEEE Trans. Power Delivery, vol. 50, no. 5, pp. 1425-1435, Oct. 2001.
- [8] E. Styvaktakis, M. H. J. Bollen and I.Y.H. Gu, "Expert system for classification and analysis of power system events", IEEE Trans. Power Delivery, vol. 17, no. 2, pp. 423-428, Apr. 2002.
- [9] J. Huang, M. Negnevitsky and D. T. Nguyen, "A neural-fuzzy classifier for recognition of power quality disturbances", IEEE Trans. Power Delivery, vol. 17, no. 2, pp. 609-616, April 2002.
- [10] J.L.J. Driesen and R. J.M. Belmans, "Wavelet based power quantification approaches", IEEE Trans. Power Delivery, vol. 52, no. 4, pp. 1232-1238, August 2003.
- [11] H. He and J. A. Starzyk, "A self-organizing learning array system for power quality classification based on wavelet transform", IEEE Trans. Power Delivery, vol. 21, no. 1, pp. 286-295, Jan. 2006.
- [12] C.H. Lin and C.H. Wang, "Adaptive wavelet networks for power quality detection and discrimination in a power system", IEEE Trans. Power Delivery, vol. 21, no. 3, pp. 1106-1113, July 2006.
- [13] A. I. Megahed, A.M. Moussa and A.E. Bayoumy, "Usage of wavelet transform in the protection of series-compensated transmission lines", IEEE Trans. Power Delivery, vol. 21, no. 3, pp. 1213-1221, July 2006.
- [14] M. Michalik, W. Rebizant, M. Lukowicz, S. J. Lee and S. H. Kang, "High-impedance fault detection in distribution networks with use of wavelet-based algorithm", IEEE Trans. Power Delivery, vol. 21, no. 4, pp. 1793-1802, October 2006.

- [15] W.R.A. Ibrahim and M.M. Morcos, "An adaptive fuzzy self-learning technique for prediction of abnormal operation of electrical systems" IEEE Trans. Power Delivery, vol. 21, no. 4, pp. 1770-1777, October 2006.
- [16] T. Tarasiuk, "Hybrid wavelet-fourier method for harmonics and harmonic subgroups measurement – case study" IEEE Trans. Power Delivery, vol. 22, no. 1, pp. 4-17, Jan. 2007.
- [17] Y.Y. Hong and B.Y. Chen, "Locating switched capacitor using wavelet transform and hybrid principal component analysis network" IEEE Trans. Power Delivery, vol. 22, no. 2, pp. 1145-1152, April 2007.
- [18] S.P. Valsan and K.S. Swarup, "Computationally efficient wavelet-transform-based digital directional protection for busbars", IEEE Trans. Power Delivery, vol. 22, no. 3, pp. 1342-1350, July 2007.
- [19] S. M. Brahma, "Distance relay with out-of-step blocking function using wavelet transform", IEEE Trans. Power Delivery, vol. 22, no. 3, pp. 1360-1366, July 2007.
- [20] M.B. I. Reaz, F. Choong, M. S. Sulaiman, F. M. Yasin and M. Kamada, "Expert system for power quality disturbance classifier", IEEE Trans. Power Delivery, vol. 22, no. 3, pp. 1979-1988, July 2007.
- [21] A.M. Gargoom, N. Ertugrul and W.L. Soong, "Investigation of effective automatic recognition systems of power quality events", IEEE Trans. Power Delivery, vol. 22, no. 4, pp. 2319-2326, October 2007.
- [22] N.I. Elkalashy, M. Lehtonen, H.A. Darwish, A.M.I. Taalab and M.A. Izzularab, "DWT based detection and transient power direction based location of high impedance faults due to leaning trees in unearthed MV networks", IEEE Trans. Power Delivery, vol. 23, no. 1, pp. 94-101, January 2008.
- [23] S. Mishra, C.N. Bhende and B.K. Panigrahi, "Detection and classification of power quality disturbances using S transform and probabilistic neural network", IEEE Trans. Power Delivery, vol. 23, no. 1, pp. 280-287, January 2008.

Sudipta Nath obtained her B.E., M.Tech. and PhD in Electrical Engineering from Regional Engineering College, Durgapur, University of Calcutta and Bengal Engineering and Science University, Shibpur in 1995, 2001 and 2007 respectively in India. She is currently holding the position of Professor, Department of Electrical Engineering, Netaji Subhash Engineering College, WB, India. Her research interests include, power systems and digital signal processing. She has number of research papers published in national and international journals.

Arindam Dey obtained his B.Tech. degree from Narula Institute of Technology in 2006 and M.Tech. degree from the Department of Electrical Engineering, Netaji Subhash Engineering College, Garia, Kolkata, India

Abhijit Chakrabarti obtained his B.E., M.Tech and PhD in Electrical Engineering in 1978, 1987 and 1991 from Regional Engineering College, Durgapur, Indian Institute of Technology, Delhi, and University of Calcutta in India, respectively. At present, he is a Professor in Electrical Engineering, Bengal Engineering and Science University, Howrah, India. He has active interest in power systems, electric circuits, and power electronics. Dr. Chakrabarti has published over 79 research papers authored a few books. He is a Fellow of Institution of Engineers (India) and ex-member of IEEE (USA).