

Sandvik Ceramic Cutting Tool Tests with an Interrupted Cut Simulator

Robert Cep, Adam Janasek, Lenka Cepova, Josef Prochazka

Abstract—The paper is dealing by testing of ceramic cutting tools with an interrupted machining. Tests will be provided on fixture – interrupted cut simulator. This simulator has 4 mouldings on circumference and cutting edge is put a shocks during 1 revolution. Criteria of tool wear are destruction of cutting tool or 6000 shocks. Like testing cutting tool material will be products of Sandvik Coromant 6190, 620, 650 and 670. Machined materials was steels 15 128 (13MoCrV6). Cutting speed ($408 \text{ m}\cdot\text{min}^{-1}$ and $580 \text{ m}\cdot\text{min}^{-1}$) and cutting feed (0,15 mm; 0,2 mm; 0,25 mm and 0,3 mm) were variable parameters and cutting depth was constant parameter.

Keywords—Ceramic Cutting Tools, Interrupted Cut, Machining, Cutting Tests.

I. INTRODUCTION

WE need a special preparation for these tests which is clamped to the lathe chuck and it is supported by the modified point which is established in tail stock sleeve. The basic construction consists of special cylinders which are milled 4 mortises (measurement 70 x 48 mm in 600 mm length) as in Fig. 1.

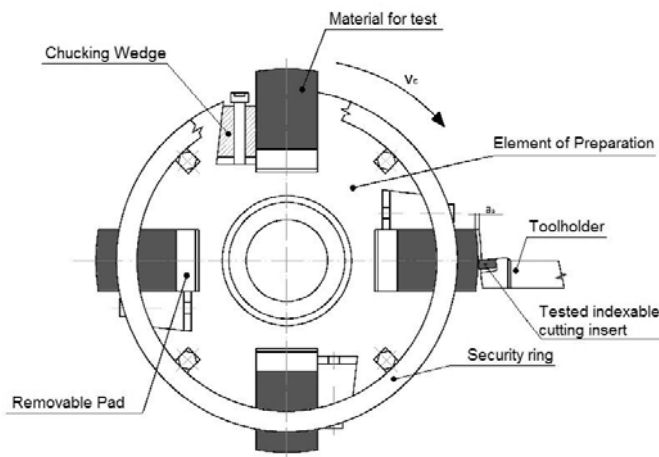

Fig. 1 Scheme of preparation for slide turning [1]

This preparation was made under the grant project GACČR 101/93/0129 in the laboratories of Department of Machining and Assembly [2]. Edge of indexable cutting insert is exposed

R. CEP is with the Faculty of Mechanical Engineering, VSB – Technical University of Ostrava, 708 33 Czech Republic (corresponding author to provide phone: +420 59 732 3193; fax: +420 59 691 6490 e-mail: robert.cep@vsb.cz).

A. JANASEK, L. CEPOVA, J. PROCHAZKA are with the Faculty of Mechanical Engineering, VSB – Technical University of Ostrava, Czech Republic (e-mails: adam.janasek@gmail.com, lenka.cepova@vsb.cz, pepa.prochazka@seznam.cz).

to 4 shocks during one revolution.

For testing is essential to the whole preparation clamp to the turning-lathe, slats put into preparation and especially to prepare and secure rigid clamping of individual slats.

The complete construction and description of individual parts is in Fig. 2.

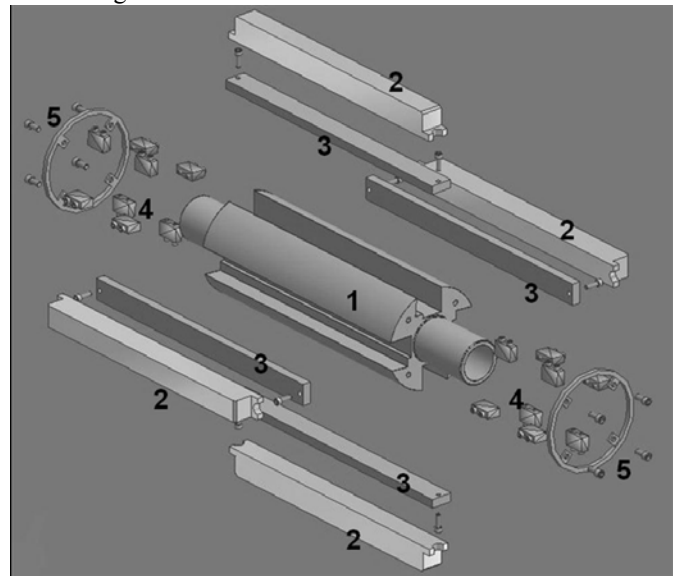

Legend: 1) Preparation – body, 2) Machined slats, 3) Interchangeable pads, 4) Chucking wedges, 5) Safety rings
Fig. 2 Scheme – disassembled preparation [3].



Fig. 3 Photo of Interrupted Cut Simulator

II. PARAMETERS OF EXPERIMENTAL CUTTING TOOL TESTS

Material of Slats

We chose steel 15 128 (13MoCrV6) as workpiece material. It is steel with special property to work at higher temperatures, heat-firm steel for strain at heightened temperatures

Machine Tool

We chose a machine which is located in the laboratories Department of Machining and Assembly. It is a turning-lathe CMM SLIVEN – we can see in Fig. 4. The turning-lathe gearbox was repaired and the turning-lathe is equipped with components for a smooth change of speed. Performance of electric machines is 6 kW and reaches at the most 2000 RPM.

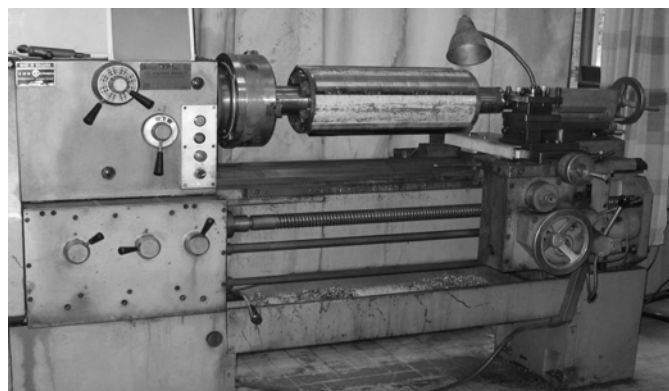

Fig. 4 Machine tool - CMM Sliven

Cutting Geometry

All types of indexable cutting inserts, which we will be tested, have a normalize shape SNGN 120716 T02020. Cutting geometry for tool testing from cutting ceramics was chosen with regard to ISO 3685 norm - Tool Life Testing of Single Point Turning Tools [4]. These indexable cutting inserts will be attached to the toolholder CSRNR 25x25M12-K.

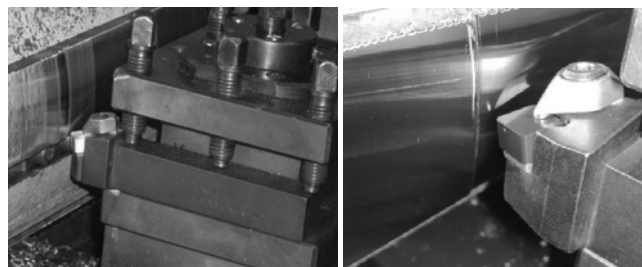

Fig. 5 Toolholder CSRNR 25x25M12- K

Tested Materials – Indexable Cutting Inserts

Materials for indexable cutting inserts from cutting ceramic were selected by the SANDVIK Coromant manufacturer. We tested 4 types of indexable cutting inserts (CC6190, CC650, CC620, CC670). These cutting inserts have a standardise shape SNGN 120716.

Cutting Parameters

We have to determine and set the cutting parameters before the start of the measurement. We choose these parameters with regard to manufacturer's recommendation of cutting ceramics and experience of the resolver. We chose these parameters (see Table 1) – for our preparation with a diameter 260 mm.

TABLE I
 USED CUTTING PARAMETERS

Cutting parameters		
Cutting speed v_c [m.min ⁻¹]	408	580
Feed f [mm]	0,15; 0,20; 0,25; 0,30	0,15; 0,20; 0,25; 0,30
Cutting depth a_p [mm]	1	

Monitoring – Number of Shocks

The main criterion of tool wear was a tool-fracture (destruction) at measurement. This moment was noticed by changing the cutting sound, sparking and worsen in surface roughness. Threshold limit was specified 6000 shocks. If indexable cutting inserts withstand this value, the experiment will be finished and a cutting insert described as satisfactory. Measurement is repeated 3 times and on several indexable cutting inserts.

TABLE II
 FEED CONVERSION AND MACHINED LENGTH FOR BOUNDARY NUMBER OF SHOCKS

Feed f [mm]	Machining length l [mm]	Number of shocks R [-]
0,15	225	6000
0,20	300	6000
0,25	375	6000
0,30	450	6000

Processing of Measurement Results

Machined slats (steel 15 128 - 13MoCrV6) should have a relatively good machinability. The values introduce in the tables are the arithmetic mean of three measurements.

III. EVALUATION OF EXPERIMENTAL MEASUREMENT

Indexable ceramic cutting inserts 6190

TABLE III
 MEASURED VALUES FOR 6190 CUTTING INSERTS

6190					
$v_c = 408$ [m.min ⁻¹] $a_p = 1$ [mm]			$v_c = 580$ [m.min ⁻¹] $a_p = 1$ [mm]		
f [mm]	l [mm]	R [-]	f [mm]	l [mm]	R [-]
0,15	225	6000	0,15	225	6000
0,20	300	6000	0,20	300	6000
0,25	375	6000	0,25	285	4560
0,30	450	6000	0,30	93	1240

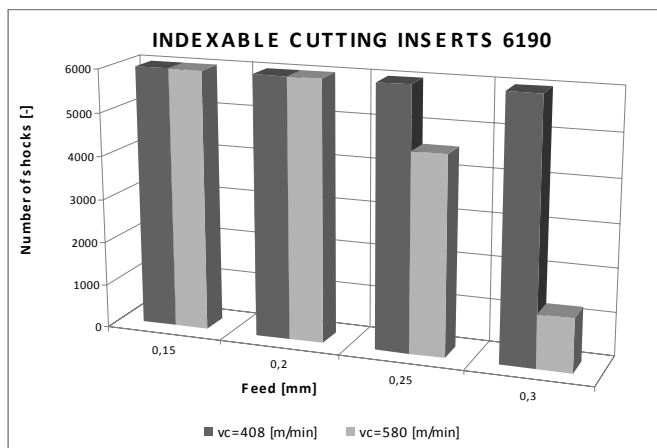

Fig. 6 Dependence – the number of shocks on feed

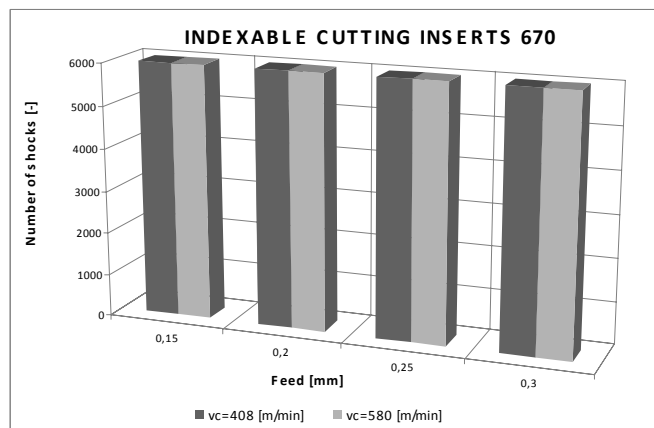

Fig. 8 Dependence – the number of shocks on feed

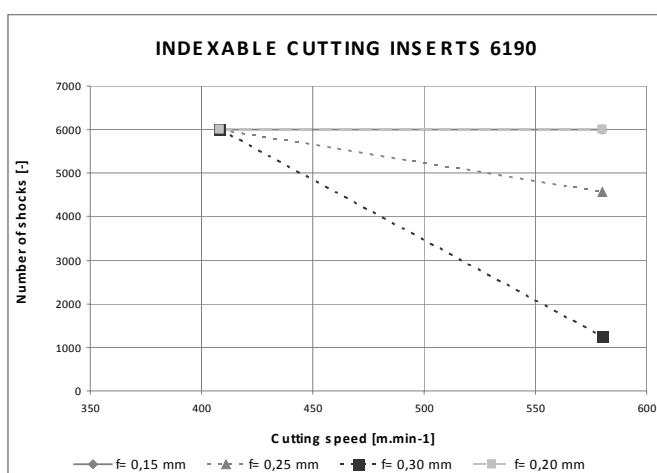

Fig. 7 Dependence – the number of shocks on cutting speed

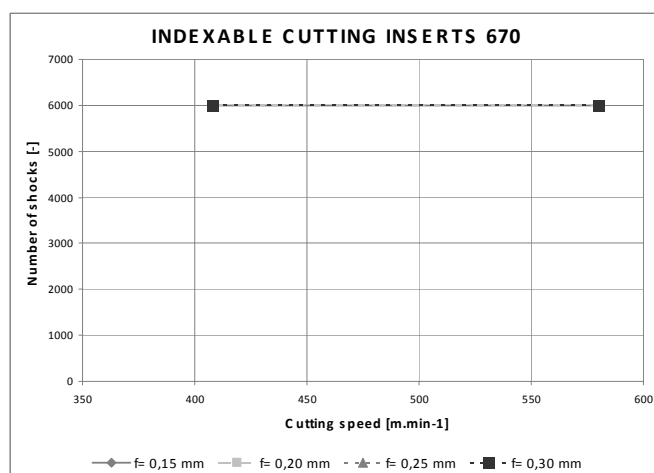

Fig. 9 Dependence – the number of shocks on cutting speed

From Fig. 6 is obvious that the number of shocks (indexable cutting inserts 6190) at lower cutting speed is reached the limit value for all feeds. The cutting inserts withstand fewer number of shocks when cutting speed is $v_c = 580 \text{ m.min}^{-1}$ and with increasing feed of cutting insert.

You can see in Fig. 7 that cutting edge withstands more shocks at lower feeds. The number of shocks is maximal at feed $f = 0,15 \text{ mm}$ a $f = 0,20 \text{ mm}$ – the number of shocks begins to decline with increasing feed.

Indexable ceramic cutting inserts 670

TABLE IV
 MEASURED VALUES FOR 670 CUTTING INSERTS

670					
$v_c = 408 \text{ [m.min}^{-1}]$ $a_p = 1 \text{ [mm]}$			$v_c = 580 \text{ [m.min}^{-1}]$ $a_p = 1 \text{ [mm]}$		
f [mm]	l [mm]	R [-]	f [mm]	l [mm]	R [-]
0,15	225	6000	0,15	225	6000
0,20	300	6000	0,20	300	6000
0,25	375	6000	0,25	375	6000
0,30	450	6000	0,30	450	6000

We can see in Fig. 8 and Fig. 9 that indexable cutting inserts 670 reached the limit number of shocks at both cutting speeds and feeds of all. That means they have a high resistance and ability to perform interrupted cut.

Indexable ceramic cutting inserts 650

TABLE V
 MEASURED VALUES FOR 650 CUTTING INSERTS

650					
$v_c = 408 \text{ [m.min}^{-1}]$ $a_p = 1 \text{ [mm]}$			$v_c = 580 \text{ [m.min}^{-1}]$ $a_p = 1 \text{ [mm]}$		
f [mm]	l [mm]	R [-]	f [mm]	l [mm]	R [-]
0,15	225	6000	0,15	225	6000
0,20	300	6000	0,20	300	6000
0,25	196	3136	0,25	31	496
0,30	23	307	0,30	14	187

The Fig. 10 shows that shocks resistance of indexable cutting inserts decreases with increasing value of feed. Cutting inserts withstand a smaller number of shocks at higher cutting speed ($v_c = 580 \text{ m.min}^{-1}$) than at lower cutting speed.

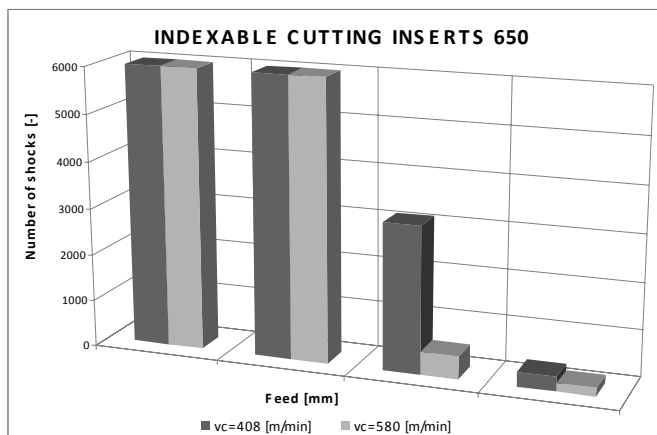

Fig. 10 Dependence – the number of shocks on feed

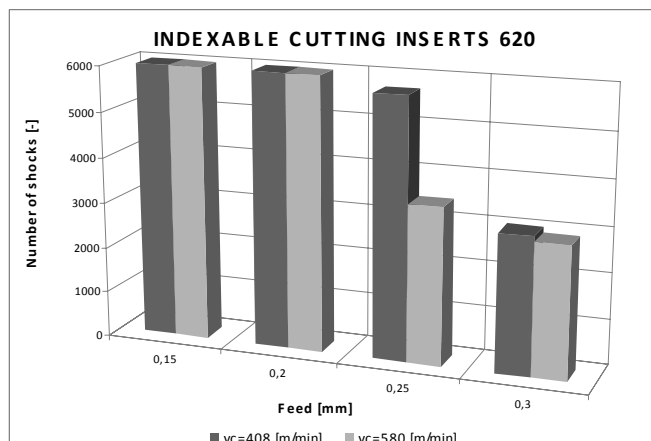

Fig. 12 Dependence – the number of shocks on feed

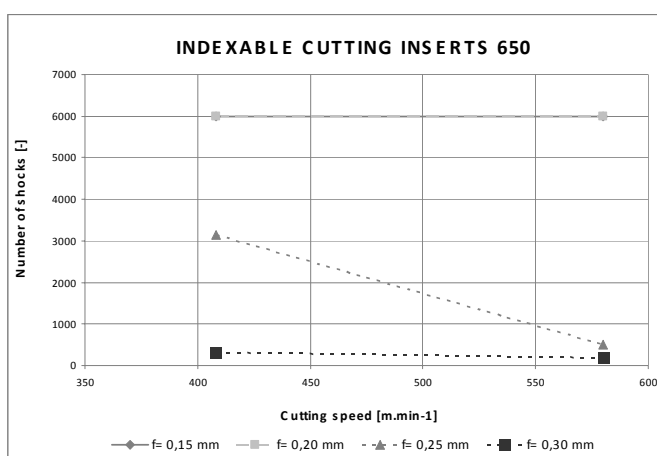

Fig. 11 Dependence – the number of shocks on cutting speed

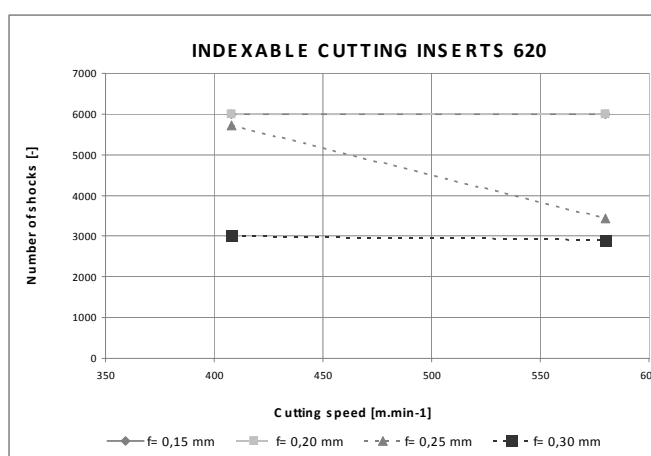

Fig. 13 Dependence – the number of shocks on cutting speed

We see in Fig. 11 that indexable cutting inserts 650 have a high resistance at low feed but resistance rapidly decreases with increasing cutting speed and feed.

Indexable ceramic cutting inserts 620

TABLE VI
 MEASURED VALUES FOR 620 CUTTING INSERTS

620					
$v_c = 408 \text{ [m.min}^{-1}]$			$v_c = 580 \text{ [m.min}^{-1}]$		
$a_p = 1 \text{ [mm]}$			$a_p = 1 \text{ [mm]}$		
f [mm]	l [mm]	R [-]	f [mm]	l [mm]	R [-]
0,15	225	6000	0,15	225	6000
0,20	300	6000	0,20	300	6000
0,25	357	5712	0,25	215	3440
0,30	226	3013	0,30	217	2893

We see in Fig. 12 and Fig. 13 that indexable ceramic-cutting inserts 620 have a very similar line chart as a cutting inserts 650 but cutting inserts 620 can withstand greater number of shocks than cutting inserts 650 at higher feeds.

Comparison and Evaluation of Results

We processed all measured values for all types of ceramic-cutting inserts from Sandvik Coromant company (6190, 670, 650, 620) which were tested. The results for all types of ceramic-cutting inserts are displayed in following diagrams (Fig. 14, Fig. 15, Fig. 16).

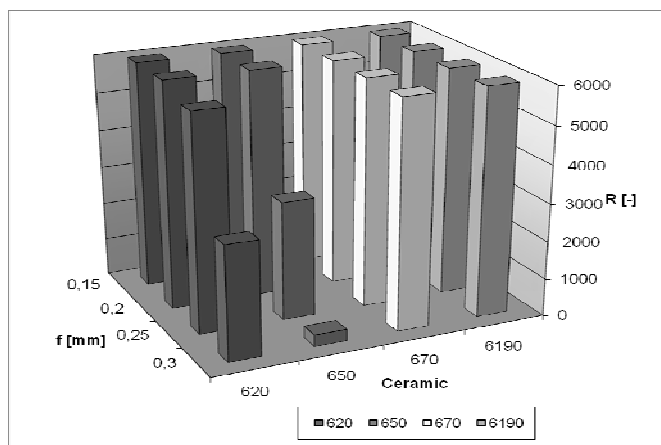

Fig. 14 Dependence – the number of shocks on feed – cutting speed $v_c = 408 \text{ m.min}^{-1}$

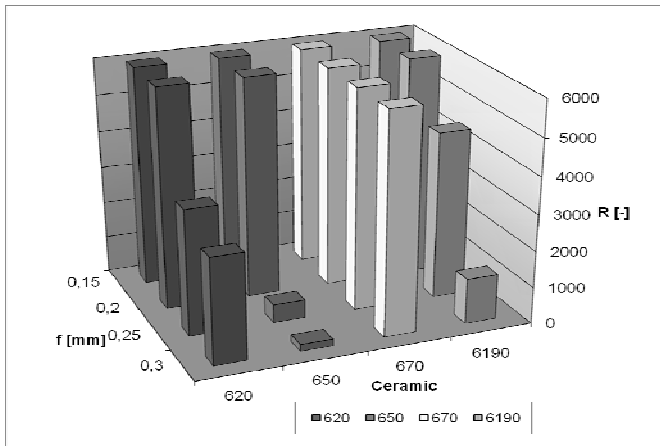

Fig. 15 Dependence – the number of shocks on feed – cutting speed $v_c = 580 \text{ m}\cdot\text{min}^{-1}$

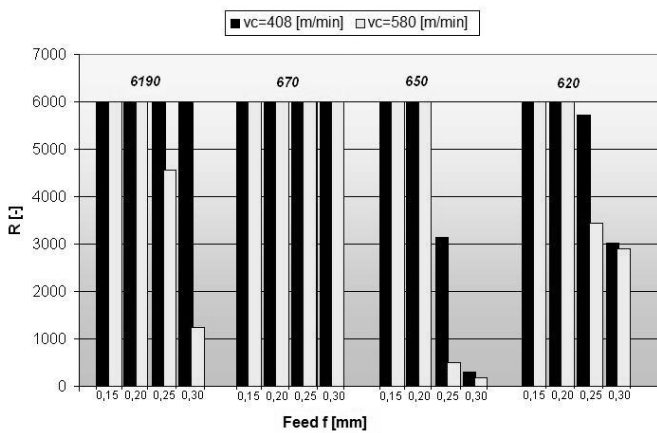

Fig. 16 Dependence – the number of shocks on feed – for both cutting speeds

Fig. 16 shows comparison dependence of the number of shocks on feed (for both cutting speeds $v_c = 408 \text{ m}\cdot\text{min}^{-1}$ and $v_c = 580 \text{ m}\cdot\text{min}^{-1}$) and for machined material 15 128. Cutting inserts 670 withstood number of shocks limit (6000) for all feeds and both cutting speeds. It concludes that the cutting inserts 670 are the most suitable for interrupted cut of all cutting inserts.

Cutting inserts 6190 withstood the maximal number of shocks for all feeds at lower cutting speed ($v_c = 408 \text{ m}\cdot\text{min}^{-1}$) but the number of shocks decreases at higher speed ($v_c = 580 \text{ m}\cdot\text{min}^{-1}$) at feed (0,25 mm a 0,30 mm). Cutting plates 6190 are suitable for interrupted cut but only at lower cutting speeds.

Cutting inserts 620 withstood the maximal number of shocks at feed (0,15mm and 0,20mm) and at both cutting speeds. The number of shocks decreases to an average value (3000 shocks) at increasing feed. The cutting inserts 620 are suitable for interrupted cut but only at low feeds.

Cutting inserts 650 withstood the maximal number of shocks at both cutting speeds - at feed (0,15 mm and 0,20 mm). The ability to withstand shocks is minimal at feed (0,25 mm a 0,30 mm).

IV. CONCLUSION

Experiments were conducted on a special preparation at longitudinal turning which was constructed at Department of Machining and Assembly, Faculty of Mechanical Engineering, VSB – TU Ostrava (within the Czech Science Foundation). The experiment allowed us to identify the behavior of ceramic cutting inserts and the suitability for use in interrupted cut at $a_p = 1 \text{ mm}$, $v_{c1} = 408 \text{ m}\cdot\text{min}^{-1}$, $v_{c2} = 580 \text{ m}\cdot\text{min}^{-1}$, $f = (0,15; 0,20; 0,25; 0,30) \text{ mm}$. We tested 4 types of ceramic cutting inserts from Sandvik Coromant Company.

All 4 selected types of ceramic cutting inserts reached the limit number of shocks (6000) - at feed $f = 0,15 \text{ mm}$ and $f = 0,20 \text{ mm}$. Tested types of ceramic cutting inserts have sufficient resistance at lower feeds and at interrupted cut.

Ceramic cutting inserts 670 is the best solution and reached the best results. This cutting inserts withstood maximal number of shocks for all feed and at both cutting speeds. Another cutting inserts 6190; it appears that they are able to withstand shocks in interrupted cut. These cutting inserts reached the limit number of shocks at all feeds - for cutting speed $v_{c1} = 408 \text{ m}\cdot\text{min}^{-1}$. Cutting inserts 6190 (at cutting speed $v_{c2} = 580 \text{ m}\cdot\text{min}^{-1}$) are able to withstand the maximal number of shocks only at feed $f = 0,15 \text{ mm}$ and $f = 0,20 \text{ mm}$. The last two ceramic cutting inserts (650 and 620) reached the limit number of shocks at feed $f = 0,15 \text{ mm}$ and $f = 0,20 \text{ mm}$ for a both cutting speeds. The ceramic cutting inserts 620 are not suitable for interrupted cut at high feeds because cutting plates are only able to withstand average number of shocks (3000). Cutting inserts 620 have a minimal resistance at higher feeds. Machining materials are suitable for both types of cut – continuous and interrupted cutting.

ACKNOWLEDGMENT

This paper was supported by the *Czech Science Foundation*, grant number 101/08/P118, entitled *Ceramic Cutting Tool Tests at Interrupted Cut*.

REFERENCES

- [1] J. REINER. "Zkoušky nástrojů z žezné keramiky na simulátoru přerušovaného řezu : diploma thesis" Ostrava : FS VŠB – TU Ostrava, 2009. 73 p.
- [2] I. MRKVIČA. "Utilization of Fine-grained Cemented Carbides for Gear Manufacturing," in *Manufacturing Technology*, 2002, vol. 2. ISSN 1213-2489.
- [3] R. CEP, P. PFEILER. "Shock Number Determination for DISAL D320 Ceramic Cutting Inserts during Interrupted Machining." in *The International Conference of the Carpathian Euroregion Specialist in Industrial Systems*. Baia Mare : North University of Baia Mare, 2008. s. 75 – 80. ISSN 1224 – 3264.
- [4] ISO 3685: 1990 - Tool Life Testing with Single Cutting Tools. 1990.
- [5] J. DOBRANSKY, M. HATALA. "Influence of selected technological parameter to quality parameters by injection moulding," in *Annals of DAAAM for 2007 & proceedings of the 18th International DAAAM Symposium : Intelligent Manufacturing & Automation*, Zadar, Croatia. Vienna : DAAAM International, 2007. 2 p. ISBN 3-901509-58-5.
- [6] J. HOUDEK, K. KOURIL. "Sintered Carbides Resistivity against Thermal and Mechanical Shocks 3 parts (in Czech)," in *MM Průmyslové Spektrum 04,05,06/2004*. Available: <http://www.mmspektrum.com/clanek/odolnost-slinutych-karbidu-proti-teplotnim-a-mechanickym-razum>.