

Improved Torque Control of Electrical Load Simulator with Parameters and State Estimation

Nasim Ullah and Shaoping Wang

Abstract—ELS is an important ground based hardware in the loop simulator used for aerodynamics torque loading experiments of the actuators under test. This work focuses on improvement of the transient response of torque controller with parameters uncertainty of Electrical Load Simulator (ELS). The parameters of load simulator are estimated online and the model is updated, eliminating the model error and improving the steady state torque tracking response of torque controller. To improve the Transient control performance the gain of robust term of SMC is updated online using fuzzy logic system based on the amount of uncertainty in parameters of load simulator. The states of load simulator which cannot be measured directly are estimated using luenberger observer with update of new estimated parameters. The stability of the control scheme is verified using Lyapunov theorem. The validity of proposed control scheme is verified using simulations.

Keywords—ELS, Observer, Transient Performance, SMC, Extra Torque, Fuzzy Logic .

I. INTRODUCTION

THE Electrical Aerodynamics Load Simulator is basically a torque servo system, which exerts loading torque on actuator under test according to flight conditions and is used for hardware in the loop simulations on ground based testing. Because of the operation of loaded actuator, the load simulator suffers from the disturbance caused by the actuator so the major problem of all types of load simulators is the extra torque. In the course of loading, the torque induced in ELS due to the actuator operation is a strong disturbance to the torque control of ELS because of rigid connection between the actuator and load simulator. The design principle of load simulator is not only to exert the loading on actuator but also it should not affect the performance of actuator. So it is necessary to study the control methods to eliminate extra torque[1].

Analyzing the mathematical model, extraneous torque is closely related to the difference of angular velocities of the actuator and load simulator. In order to get high control performance, the velocity synchronization of two output shaft between the actuator and the load simulator is required [2].

Wang proposed hybrid fuzzy PID to improve the torque tracking performance [3]. Q Fang proposed a novel design method to solve mixed sensitivity optimization for disturbance observer to eliminate extra torque in ELS. [4].

Besides Extra torque parameters uncertainty, the model errors of load simulator can lead to poor control performance

U. Nasim is PhD student in School of Automation Science and Electrical Engineering, Beihang University, Beijing, 10091 China; (e-mail: cengr2009@live.com).

S. Wang is Professor in School of Automation Science and Electrical Engineering, Science and Technology on Aircraft Control Laboratory, Beihang University, Beijing, 10091 China; (e-mail: shaopingwang@vip.sina.com).

It is crucial to estimate the parameters online and update the model and model based controller. Due to sensors cost, noise and the states not available for measurement, sensor less control is the hot research topic in modern electromechanical systems. Ohnishi proposed sensor less motion control for motors with estimation and identification of system states [5]. Yang proposed observer based inertial identification, for DC servo applications [6]. Zhang proposed model free method to estimate inertia from motor speed response [7].

This work mainly focuses on online fuzzy gain tuning to eliminate chattering and improve the tracking response of load simulator. The estimated parameters and states are replaced and the model and model based control are updated. In previous work it was observed that after updating the model and model based controller, the steady state torque tracking response of ELS is very satisfactory, but as the same time the transient performance was poor. To eliminate this problem the controller gain is also updated online using fuzzy logic based on amount of uncertainty in the model parameters. The states which cannot be measured directly are measured using state observer with parameters of the observer are also updated online. The general working diagram of ELS is shown in Fig.1. This paper is organized as follows. Section II discusses the derivation of mathematical model with parameters variation. Section III designs the state observer, adaptive robust controller, Parameters estimation Algorithm and fuzzy online gain tuning of torque controller. Section IV discusses the simulation results and section V gives the conclusions.

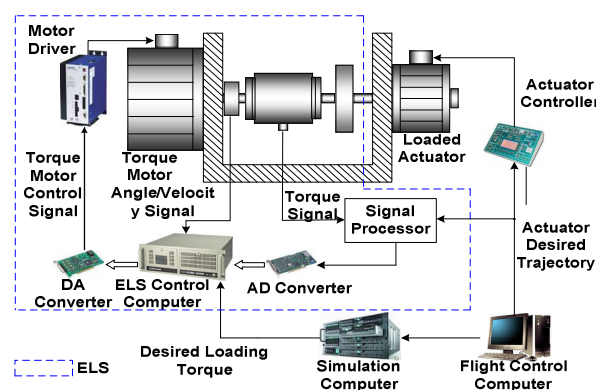

Fig. 1. Working Diagram of ELS

II. STATE MODEL WITH PARAMETRIC UNCERTAINTY

A. Assumptions for Observer and ELS Modeling

Assumption 1: The convergence time of parameters estimation to its final value is very small as compared to period of command signal

Assumption 2: If the upper and lower bounds of parameters uncertainty are known then the estimated parameters are updated with the observer equation using following relation because ideal convergence time of parameters to their final values cannot be zero.

if
($\dot{P}_{est} \approx 0$) or ($\dot{P}_{est} < \sigma$) then ($P_{obs} = P_{est}$)
else
($P_{obs} = P_{nom}$)

P_{obs} is state parameter for observer

P_{nom} is the nominal state parameter

P_{est} is estimated state parameter of actual plant

σ is smallest upper bound of variation and it represents the admissible convergence error of estimated parameters to the final value.

Assumption 3: The parametric uncertainty in the torque servo system is bounded such that the upper bounds of all the parameters are known.

$$\begin{aligned} J_{min} &\leq J \leq J_{max} \\ B_{min} &\leq B \leq B_{max} \\ K_{t(min)} &\leq K_t \leq K_{t(max)} \end{aligned}$$

Assumption 4: Electrical dynamics of torque motor is faster than the mechanical dynamics so we can ignore $L \frac{di}{dt}$ and the

Assumption 5: The back emf constant K_b is assumed to be constant to avoid complexity.

B. State Model derivation

Based on the modeling assumption let $\Delta J, \Delta B$ and ΔK_t is the amount of bounded parametric uncertainty then voltage and torque balance equations of DC torque servo motor can be described as.

$$u = iR + L \frac{di}{dt} + K_b \omega_m \quad (1)$$

$$(K_t + \Delta K_t) i = (J + \Delta J) \frac{d\omega_m}{dt} + (B + \Delta B) \omega_m + T_l \quad (2)$$

Where J, B, K_b and K_t are the mechanical parameters i.e. moment of inertia, damping coefficient, back emf constant and motor torque constant, R and L are the electrical parameters of the system. T_L is the output load torque and can be written as

$$T_L = K_s (\theta_m - \theta_a) \quad (3)$$

Here θ_m is angular displacement of torque motor, θ_a is angular displacement of actuator and K_s is stiffness of torque sensor. When the reference command of torque motor is zero the

movement of actuator will induce back emf. Due to this back emf armature current will flow and torque will be generated in the torque motor. Torque balance equation can be expressed as

$$T_e^* = -(J + \Delta J) \ddot{\theta}_a - (B + \Delta B) \dot{\theta}_a + T_d \quad (4)$$

T_d is the mechanical torque on actuator shaft. $T_e^* = K_t i^*$, is the electromagnetic torque in torque motor which is the extra torque, i^* is the armature current generated in torque motor due to back emf generated. If Torque reference is not zero for torque motor then (2) and (4) can be combined as

$$T_e + T_e^* = (J + \Delta J) (\ddot{\theta}_m - \ddot{\theta}_a) + (B + \Delta B) (\dot{\theta}_m - \dot{\theta}_a) + T_l + T_d \quad (5)$$

$$(J + \Delta J) (\ddot{\theta}_m - \ddot{\theta}_a) = (K_t i + \Delta K_t i + T_e^*) - (B + \Delta B) (\dot{\theta}_m - \dot{\theta}_a) - T_l - T_d \quad (6)$$

$$(\ddot{\theta}_m - \ddot{\theta}_a) = \frac{(K_t i + \Delta K_t i + T_e^*)}{(J + \Delta J)} - \frac{(B + \Delta B)}{(J + \Delta J)} (\dot{\theta}_m - \dot{\theta}_a) - \frac{1}{(J + \Delta J)} (T_l + T_d) \quad (7)$$

Multiply both sides of (7) by K_s

$$K_s (\ddot{\theta}_m - \ddot{\theta}_a) = \frac{K_s (K_t i + \Delta K_t i + T_e^*)}{(J + \Delta J)} - \frac{K_s}{(J + \Delta J)} (T_l + T_d) - \frac{K_s (B + \Delta B)}{(J + \Delta J)} (\dot{\theta}_m - \dot{\theta}_a) \quad (8)$$

$$\ddot{T}_L = \frac{K_s K_t i}{J + \Delta J} + \frac{K_s \Delta K_t i}{J + \Delta J} + \frac{K_s T_e^*}{J + \Delta J} - \frac{B}{J + \Delta J} \dot{T}_L - \frac{\Delta B}{J + \Delta J} \dot{T}_L - \frac{K_s}{J + \Delta J} (T_l + T_d) \quad (9)$$

$$\ddot{T}_L = \frac{K_s K_t i}{J + \Delta J} + \frac{K_s \Delta K_t i}{J + \Delta J} - \frac{B}{J + \Delta J} \dot{T}_L - \frac{\Delta B}{J + \Delta J} \dot{T}_L - \frac{K_s}{J + \Delta J} (T_l + T_d + T_e^*) \quad (10)$$

Considering actuator effects in (2), then

$$i = \frac{u}{R} - \frac{K_b}{R} (\omega_m - \omega_a) \quad (11)$$

We assumed that the electrical dynamics of torque motor is faster than the mechanical dynamics so we can ignore $L \frac{di}{dt}$ factor in (11). Put (11) in (12)

$$\ddot{T}_L = \left(\frac{K_s K_t}{J + \Delta J} + \frac{K_s \Delta K_t}{J + \Delta J} \right) \left[\frac{u}{R} - \frac{K_b}{R} (\omega_m - \omega_a) \right] - \frac{B}{J + \Delta J} \dot{T}_L - \frac{\Delta B}{J + \Delta J} \dot{T}_L - \frac{K_s}{J + \Delta J} (T_l + T_d + T_e^*) \quad (12)$$

Simplifying (12) and separating terms including \dot{T}_L and u we get

$$\ddot{T}_L = \left(\frac{K_s K_t}{(J + \Delta J)R} + \frac{K_s \Delta K_t}{(J + \Delta J)R} \right) u - \frac{K_s}{J + \Delta J} (T_l + T_d + T_e^*) - \left(\frac{K_b K_t}{(J + \Delta J)R} + \frac{B}{(J + \Delta J)} \right) + \left(\frac{K_b \Delta K_t}{(J + \Delta J)R} + \frac{\Delta B}{(J + \Delta J)} \right) \dot{T}_L \quad (13)$$

$$\ddot{T}_L = -(a + \Delta a) \dot{T}_L + (b + \Delta b) u - f(T_{extra}, \Delta J, \Delta B, \Delta K_t) \quad (14)$$

Let $x_1 = T_L$ and $x_2 = \dot{T}_L$ The state equation is represented as

$$\begin{aligned} \dot{x}_1 &= x_2 \\ \dot{x}_2 &= -\hat{a}x_2 + \hat{b}u - f(T_{extra}, \Delta J, \Delta B, \Delta K_t) \\ y &= x_1 \end{aligned} \quad (15)$$

Here

$$\hat{a} = (a + \Delta a) = \frac{K_b K_t}{(J + (\Delta J)R} + \frac{B}{(J + \Delta J)} + \left(\frac{K_b \Delta K_t}{(J + \Delta J)R} + \frac{\Delta B}{(J + \Delta J)} \right) \quad (16)$$

$$\hat{b} = b + \Delta b = \frac{K_s K_t}{(J + \Delta J)R} + \frac{K_s \Delta K_t}{(J + \Delta J)} \quad (17)$$

III. TORQUE CONTROLLER WITH PARAMETERS AND STATE ESTIMATION

Let T_L be output load torque and T_r be the desired torque signal, we define tracking error and its derivative is as

$$\begin{aligned} e &= T_L - T_r \\ \dot{e} &= \dot{T}_L - \dot{T}_r \end{aligned} \quad (18)$$

So we can get the error surface and its derivative are defined as

$$\begin{aligned} s &= \dot{e} + \lambda e \\ \dot{s} &= \ddot{e} + \lambda \dot{e} \end{aligned} \quad (19)$$

We introduce a new variable as

$$\begin{aligned} \dot{T}_n &= \dot{T}_r - \lambda e \\ \lambda e &= \dot{T}_r - \dot{T}_n \\ s &= \dot{T}_L - \dot{T}_n \\ \dot{s} &= \ddot{T}_L - \ddot{T}_n \end{aligned} \quad (20)$$

Put \ddot{T}_L from (14) into (20) we get

$$\dot{s} = -(a + \Delta a) \dot{T}_L + (b + \Delta b) u - f(T_{extra}, \Delta J, \Delta B, \Delta K_t) - \dot{T}_n \quad (21)$$

We choose control as

$$u = \frac{1}{\hat{b}} \left(\hat{a} \dot{T}_L + \hat{f}(T_{extra} \theta) + \dot{T}_n \right) - K_d \cdot s - w \cdot \text{sgn}(s) \quad (22)$$

A. Design Idea of Enhanced Torque Controller

The designed torque controller in (22) is based on assumption of parameters variations of ELS. The controller has several limitations which are discussed in detail. The gains term K_d and w are fixed with respect to parameters uncertainty. The state equation contains a derivative of load torque and for practical applications the state is directly not measurable. So we suggest observer to measure the unknown state with parameters uncertainty of plant.

This work proposes fuzzy logic based online gain scheduling for K_d and w to improve transient response of torque control system based on amount of parameters variation a and b of the state model. Secondly a luenberger observer will be used to estimate \dot{T}_L in presence of parameters uncertainty of model. To update the new parameters in the observer, the convergence rate of parameters estimation algorithm should be fast enough, which is impossible. To solve this problem a fuzzy switch is used to switch between nominal and the new estimated parameters. The proposed enhanced control scheme is shown in Fig.2.

B. State Observer with Parameters Estimation and update

The controller derived in (22) contains states and model parameters to be estimated. Since practically the parameters of EALS will have uncertainty depending on operating conditions, this work propose state observer with update of real plant parameters which are estimated online. From (15) the observer can be represented as

$$\begin{aligned} \dot{\hat{x}}_2 &= -\hat{a} \hat{x}_2 + \hat{b} u + K(y - \hat{y}) \\ \hat{y} &= \hat{x}_1 \end{aligned} \quad (23)$$

The state observer also contains model parameters which may vary during operation depending on operating conditions, so it is also necessary to update the new estimated parameters in to the observer to have a real estimate of plant state. To estimate the plant parameters we assume a nominal plant and a plant with parameter variation. In the previous work fuzzy logic was used to estimate the extra torque. [16]. The idea is extended for parameters estimation. Fuzzy logic is used to estimate the extra torque of nominal plant and the total disturbance of real plant including the extra torque and the disturbance due to parameters uncertainty. The difference of the two is used to estimate the parameters variation as shown in Fig.2. Let \hat{K}_t be the estimated value of motor torque constant

$$T_{de} = T_{dp} - T_{dn} = f(T_{extra}, \Delta J, \Delta B, \Delta K_t) - f(T_{extra}) \quad (24)$$

$$T_{de} = f(\Delta J, \Delta B, \Delta K_t) = \Delta K_t i + \Delta J(\alpha_m - \alpha_a) + \Delta B(w_m - w_a) \quad (25)$$

Here $\Delta K_t = (K_t - \hat{K}_t)$, $\Delta J = (J - \hat{J})$ and $\Delta B = (B - \hat{B})$

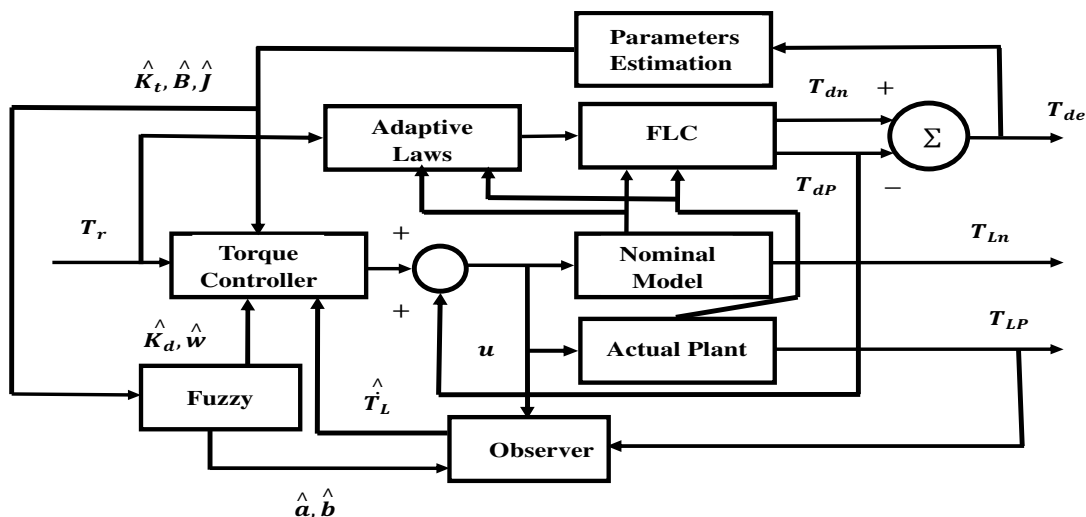

Fig. 2. Enhanced Torque Controller for ELS

Hence the adaptation algorithm for estimating motor torque constant can be expressed as

$$\begin{aligned} \frac{\partial T_{de}}{\partial \hat{K}_t} &= -i \\ \frac{\partial \hat{K}_t}{\partial t} &= -K_1 \cdot T_{de} \cdot \frac{\partial T_{de}}{\partial \hat{K}_t} \\ \frac{\partial \hat{K}_t}{\partial t} &= K_1 \cdot T_{de} \cdot i \\ \hat{K}_t &= \frac{K_1 T_{de} i}{S} + K_t \end{aligned} \quad (26)$$

Where K_1 is the learning rate if we know the upper bound of parameter variation then learning rate can be expressed as

$$K_1 = (K_{max} - \hat{K}_t) \cdot K_{10}$$

Similarly uncertainty of moment of inertia J depends on acceleration. Let \hat{J} be the estimated moment of inertia then

$$\begin{aligned} \frac{\partial T_{de}}{\partial \hat{J}} &= -(\alpha_m - \alpha_a) \\ \frac{\partial \hat{J}}{\partial t} &= -K_2 \cdot T_{de} \cdot \frac{\partial T_{de}}{\partial \hat{J}} \\ \hat{J} &= \frac{K_2 \cdot T_{de} \cdot (\alpha_m - \alpha_a)}{S} + J \end{aligned} \quad (27)$$

If J_{max} is the upper bound of moment of inertia then learning rate can be expressed as

$$K_2 = (J_{max} - \hat{J}) \cdot K_{20}$$

Uncertainty of B depends on speed of the actual plant and also the actuator influence.

$$\begin{aligned} \frac{\partial T_{de}}{\partial \hat{B}} &= -(w_m - w_a) \\ \frac{\partial \hat{B}}{\partial t} &= -K_3 \cdot T_{de} \cdot \frac{\partial T_{de}}{\partial \hat{B}} \end{aligned}$$

$$\hat{B} = \frac{K_3 \cdot T_{de} \cdot (w_m - w_a)}{S} + B \quad (28)$$

If B_{max} is the upper bound of damping coefficient then learning rate can be expressed as

$$K_3 = (B_{max} - \hat{B}) \cdot K_{30}$$

Here K_{10}, K_{20}, K_{30} are the initial learning rates. From (26), (27) and (28) Assuming the electrical parameters are constant we can calculate the estimated values of parameters \hat{a} and \hat{b} . The update of the estimated parameters in the observer model is done through a fuzzy switch function to make the estimation algorithm efficient. The main purpose of the fuzzy switch is to let the estimation algorithm converging to the maximum value of the parameters to be estimated and then replace the new parameters, other wise use nominal value at the beginning.

C. Online Fuzzy Gain Tuning based on State Parameters Variation

The numerical values of K_d and w are selected assuming no variation in the plant parameters. But practically there will be uncertainty in the mechanical parameters of ELS, which can affect the control performance. So it is necessary to map the controller gains according to parameters variation. So enhanced control equation can be written as

$$u = \frac{1}{b} \left(\hat{a} \dot{T}_L + \hat{f}(T_{extra}\theta) + \ddot{T}_n \right) - \hat{K}_d \cdot s - \hat{w} \cdot \text{sgn}(s) \quad (29)$$

With the assumption that the uncertainty in the mechanical parameters of ELS is significant so the range of input parameters is chosen as $[a, b]$, $[(60, 120), (40, 191)]$ and that for output parameters $[K_d, w]$ is $[(2, 20), (1, 5)]$. The typical fuzzy rules for gain tuning are shown in Table.1. For output parameters center average denazification method is adopted. Fig.4 shows online fuzzy parameters tuning with two inputs $[a, b]$ and one input T_{de} . Since estimation of $[a, b]$ are derived from T_{de} . So it is much better to use it for gain tuning instead of two parameters. Thus the numbers of rules are reduced with same performance. Online

tuning of controller gains K_d and w improves the tracking capability of torque control system especially in transient time. Since the parameters estimation algorithm for J, B and

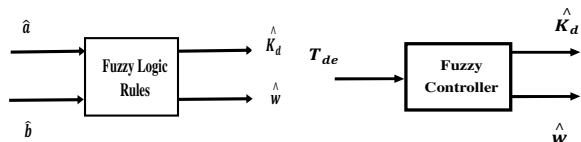

Fig. 3. Online Fuzzy Gain Tuning

K_t directly depends on T_{de} , the number of rules for online gain tuning can be reduced by using one input parameter T_{de} .

Table.1. Fuzzy Rules for Online Gain Tuning

\hat{a}/\hat{b}	\hat{K}_d			\hat{w}		
	S	M	B			
S	B	M	M	M	S	S
M	M	M	S	S	S	B
B	S	M	S	M	S	B

The big advantage of using T_{de} is the reduction of number of rules with the same performance as in the two parameters input. The following rules are used for gain tuning.

- If T_{de} is big then \hat{K}_d is big and \hat{w} is medium
- If T_{de} is medium. then \hat{K}_d is medium and \hat{w} is small
- If T_{de} is small. then \hat{K}_d is small and \hat{w} is small

IV. STABILITY PROOF

Choose Lyapunov function as

$$V = \frac{1}{2}(s^2 + \sum_{i=1}^n \eta_i \tilde{\theta}_i^2) \quad (30)$$

where $\tilde{\theta}_i = \hat{\theta}_i - \theta$ differentiating V we get

$$\dot{V} = s\dot{s} + \sum_{i=1}^n \eta_i \tilde{\theta}_i \dot{\tilde{\theta}}_i \quad (31)$$

Put value of \dot{s} from (21) into above equation we get

$$\dot{V} = s((- \hat{a}\dot{T}_L + \hat{b}u - f(T_{extra}|\theta)) - \ddot{T}_n) + \sum_{i=1}^n \eta_i \tilde{\theta}_i \dot{\tilde{\theta}}_i \quad (32)$$

Put u from (29) into (32), we get

$$\dot{V} = s(- \hat{a}\dot{T}_L + \hat{a}\dot{T}_L + \hat{f}(T_{extra}/\theta) + \ddot{T}_n - \hat{K}_d s - \hat{w}.sgn(s) - f(T_{extra} - \ddot{T}_n) + \sum_{i=1}^n \eta_i \tilde{\theta}_i \dot{\tilde{\theta}}_i) \quad (33)$$

We define fuzzy approximation error as $e_f = f(T_{extra}) - \hat{f}(T_{extra})/\theta^*$, then equation (33) can be simplified as

$$\dot{V} = s(\hat{f}(T_{extra}/\theta) - f(T_{extra}) - \hat{K}_d s - \hat{w}.sgn(s)) + \sum_{i=1}^n \eta_i \tilde{\theta}_i \dot{\tilde{\theta}}_i \quad (34)$$

$$\dot{V} = s(\hat{f}(T_{extra}/\theta) - \tilde{f}(T_{extra}/\theta^*) - ((f(T_{extra}) - \tilde{f}(T_{extra}/\theta^*) - \hat{K}_d s - \hat{w}.sgn(s)) + \sum_{i=1}^n \eta_i \tilde{\theta}_i \dot{\tilde{\theta}}_i) \quad (35)$$

From [19]

$$\tilde{\theta}_i \xi_i(\theta, \dot{\theta}) = \hat{f}(T_{extra}/\theta) - \tilde{f}(T_{extra}/\theta^*)$$

Then (35) can be simplified as

$$\dot{V} = s(\tilde{\theta}_i \xi_i(\theta, \dot{\theta}) - e_f - \hat{K}_d s - \hat{w}.sgn(s)) + \sum_{i=1}^n \eta_i \tilde{\theta}_i \dot{\tilde{\theta}}_i \quad (36)$$

$$\dot{V} = s(-e_f - \hat{K}_d s - \hat{w}.sgn(s)) + \sum_{i=1}^n \eta_i \tilde{\theta}_i \dot{\tilde{\theta}}_i + s_i \tilde{\theta}_i \xi_i(\theta, \dot{\theta}) \quad (37)$$

Define the Adaptive Law as

$$\dot{\tilde{\theta}}_i = -\eta_i^{-1} s_i \xi_i(\theta, \dot{\theta}) \quad (38)$$

Simplifying equation(37) using the adaptive law as

$$\dot{V} = s(-e_f - \hat{K}_d s - \hat{w}.sgn(s)) \quad (39)$$

We assume that ideal fuzzy compensating error e_f is approaching zero in finite time, and by choosing proper range of \hat{K}_d and \hat{w} it can be shown as

$$\dot{V} = -s.\hat{K}_d.s - s.\hat{w}.sgn(s) \leq 0 \quad (40)$$

From (40) if the range of values of \hat{K}_d and \hat{w} is properly chosen to compensate for uncertainties then \dot{V} is less than zero which proves the stability of proposed control scheme.

V. SIMULATION RESULTS

A. Parameters and State Estimation Simulation

The estimated mechanical parameters are shown in Fig.4, Fig.5 and Fig.6. Convergence of estimation is dependent on learning rate. From simulation results it is clear that the convergence time is almost one tenth of the total period of command reference signal. The observed states of model are shown in Fig7 and Fig8. The observed states have less than 1 percent error in transient time which is acceptable.

B. Torque Tracking performance without fuzzy gain Tuning

Torque tracking response without fuzzy gain tuning, with and without model parameters update is shown in Fig.9 where $T_r = 10.\sin(2.(\pi).10.t)$, $f = (10Hz)$, $B1 = 4B$, $J1 = 2J$ and $K_t = 2K_t$. From simulation result it is clear that without updating the estimated parameters in the equivalent model based control of torque controller the torque tracking response is not very good and the tracking error is more than $(10N.m)$ in transient time and $(2N.m)$ until one

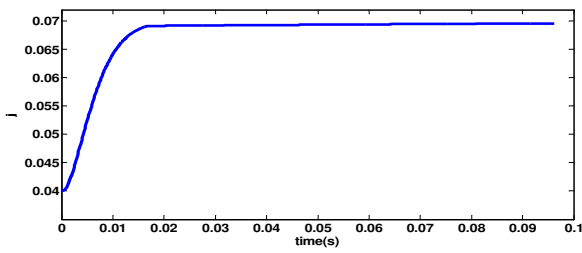

Fig. 4. Moment of Inertia estimation

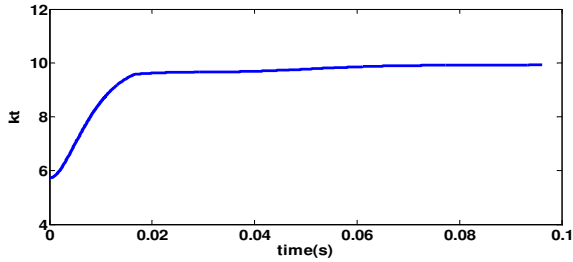

Fig. 5. Motor Torque Constant estimation

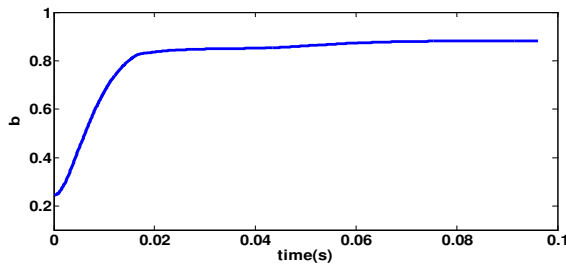

Fig. 6. Damping Coefficient estimation

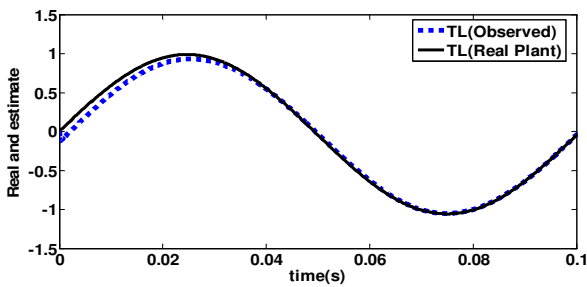

Fig. 7. Observed and estimated load Torque

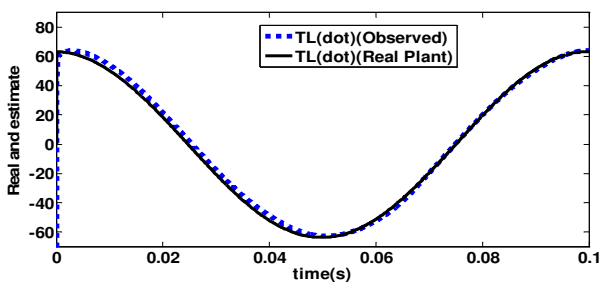

Fig. 8. Observed and estimated load torque derivative

period cycle of reference command cycle. The torque tracking performance is enhanced with updated parameters in the model based equivalent control in the steady state but during transient time the tracking error ($3N.m$) which exist until half cycle of reference command cycle

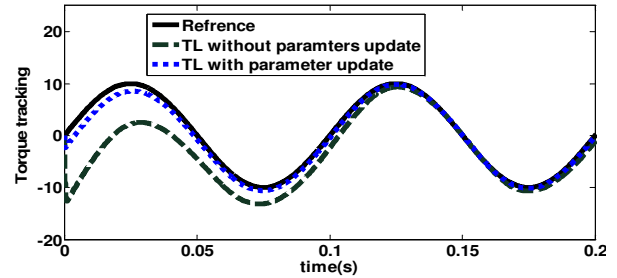

Fig. 9. Torque Tracking without Fuzzy gain Tuning

C. Torque Tracking performance with fuzzy gain Tuning

Torque tracking performance with fuzzy online gain tuning is shown in Fig10. The transient torque tracking error is almost compensated as compared to the previous result discussed. There is almost negligible tracking error over the entire cycle.

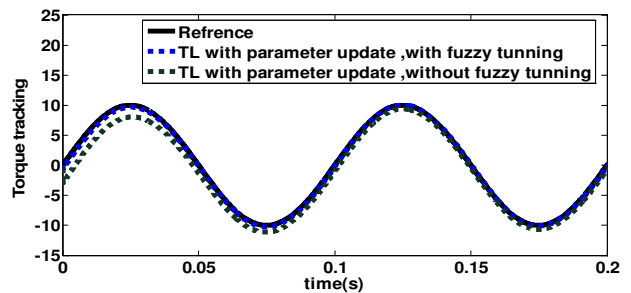

Fig. 10. Torque Tracking with Fuzzy gain Tuning

The control input without and with fuzzy gain tuning is shown in Fig 11 and 13. Fig 12 is the zoom view of control input without fuzzy gain tuning. There is significant chattering which can lead to poor control performance. By comparing the results the control input with fuzzy gain tuning is chattering free.

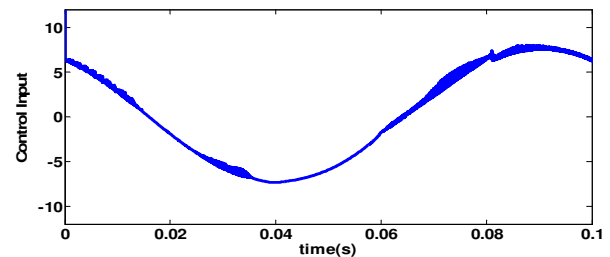

Fig. 11. Control Signal without Fuzzy gain Tuning

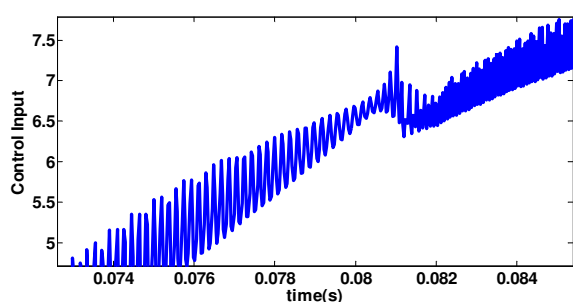

Fig. 12. Chattering in Control Signal without Fuzzy gain Tuning

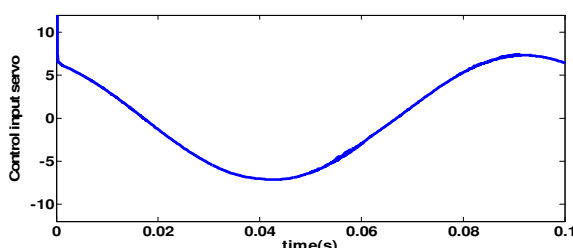

Fig. 13. Control Signal with Fuzzy gain Tuning

VI. CONCLUSION

Torque controller with mechanical parameters uncertainty with online fuzzy gain tuning based on amount of uncertainty is implemented to improve transient response of torque tracking. The states are estimated through a state observer. The parameters of observer are also updated after estimation. The simulation results indicate that torque tracking error is less than 1 percent with above proposed method.

ACKNOWLEDGMENT

The authors would like to appreciate the support of Program 111 of China, 863 Hi-Tech program (2009AA04Z412) and BUAA Fund of Graduate Education and Development.

REFERENCES

- [1] J. Zongxia, L. Chenggong, and R. Zhiting, "The extraneous torque and compensation control on the electrical load simulator", 5th International symposium on instrumentation and control technology, SPIE volume .5253,2003.
- [2] Z. X. Jiao, R. X. GAO,Q. Hua, and S. P. Wang, "The Velocity Synchronizing Control on the Electro-Hydraulic Load Simulator", Chinese Journal of Aeronautics, vol. 17 no. 1, February 2004.
- [3] X. Wang, S. Wang, and X. Wang, "Electrical load simulator based on velocity loop compensation and improved fuzzy PID", IEEE International symposium on industrial electronics(ISIE 2009),Seoul Olympic parktel ,Seoul, Korea, July 5-8 ,2009.
- [4] Q. Fang, Y. Yao, and X.C. Wang, "Disturbance observer design for electric aerodynamics load simulator", Proceeding of 4th internal conference on machine learning and cybernetics, Guangzhou, August 18-21, 2005
- [5] K. Ohnishi, N. Matsui, and Y. Hori, "Estimation, Identification and sensor less control in motion control system", Proceedings of the IEEE, Vol.82, No.8, August 1994.
- [6] S. M. Yang, and Y. J. Deng, "Observer based inertial identification for Auto tuning servo motors drive", IAS 2005 IEEE.
- [7] B. Zhang, Y. Li and Y. Zuo, "A DSP-based fully digital PMSM servo drive using on-line self-tuning PI controller", Proceeding of the 3rd Power Electronics and Motion Control Conference, vol. 2, Aug. 2000.

- [8] R. Yuan, J. Luo,Z. wu, and K. Zhao, "Study on Passive Torque Servo System Based on H Infinity Robust Controller", Proceedings of the 2006 IEEE International Conference on Robotics and Biometrics December 17 - 20, 2006, Kunming, China.
- [9] J. Fan, Z. Zheng, and M. Lv, "Optimal sliding mode variable structure control for Load simulator", 2nd International Symposium on Systems and Control in Aerospace and Astronautics, 2008 ISSCAA 2008.
- [10] X. Wang, and D. Feng, "A Study on Dynamics of Electric Load Simulator Using Spring beam and Feed forward Control Technique", 2009 Chinese Control and Decision Conference (CCDC 2009)
- [11] Y. Huang, K. Chen, and J. Wei, "Robust Controller Design and Experiment for Electric Load Simulator", 2010 3rd International Conference on Advanced Computer Theory and Engineering (ICACTE).
- [12] W. Xin, and F. D Zhu, "Load Simulator Design and Ground Test of Near Space Hypersonic Vehicle", Journal of System Simulation, Vol. 21 No. 19, Oct., 2009.
- [13] H. Yong, X. Lu, Y. Jie and S. Li, "The Controller Designed for motor servo loading system based on ITAE", 1994-2010 China academic journal.
- [14] L. Peng, and L. Hui, "Controller Design for missile rudder electric loading simulation system", Journal of Computer, measurement and control, 2010.
- [15] G. Jing, L. Cao and R. M. In, "Simulation of control method of torque servo system with position disturbance", Journal of Beijing Institute of Machinery, Vol. 20 No. 2, Jun. 2005.
- [16] U. Nasim, S. Wang, and J. Aslam, "Adaptive Robust Control of Electrical Load Simulator based on Fuzzy Logic Compensation", International Conference on Fluid Power and Mechatronics 17-20 August 2011, Beijing China.
- [17] X. Wang, D. Feng, and S. Sun, "Electric load motion control system design with invariance theory", IEEE Chinese control and decision conference (CCDC),2009
- [18] B. K. Yoo, and W. C. Ham, "Adaptive Control of Robot Manipulators Using Fuzzy Compensator", IEEE Transaction on Fuzzy Systems, Vol.8, No.2, April 2000.