

# Damping of Power System Oscillations by using coordinated tuning of POD and PSS with STATCOM

A. S. P.Kanojia, and B. Dr.V.K.Chandrakar

**Abstract**—Static synchronous compensator (STATCOM) is a shunt connected voltage source converter (VSC), which can affect rapid control of reactive flow in the transmission line by controlling the generated a.c. voltage. The main aim of the paper is to design a power system installed with a Static synchronous compensator (STATCOM) and demonstrates the application of the linearised Phillips-heffron model in analyzing the damping effect of the STATCOM to improve power system oscillation stability. The proposed PI controller is designed to coordinate two control inputs: Voltage of the injection bus and capacitor voltage of the STATCOM, to improve the Dynamic stability of a SMIB system. The power oscillations damping (POD) control and power system stabilizer (PSS) and their coordinated action with proposed controllers are tested. The simulation result shows that the proposed damping controllers provide satisfactory performance in terms of improvements of dynamic stability of the system.

**Keywords**—Damping oscillations, FACTS, STATCOM, dynamic stability, PSS, POD, Coordination.

## I. INTRODUCTION

Fixed or mechanically switched capacitors and reactors have long been employed to increase the steady-state power transmission by controlling the voltage profile along the line. The FACTS devices are known to improve both the transient as well as dynamic performance of a power system. The static synchronous compensators (STATCOM) provide shunt compensation in a way similar to the static var compensation (SVC), but utilize a voltage source converter rather than shunt capacitors and reactors [1]. STATCOM can control voltage magnitude and to a small extent, the phase angle in a very short time and therefore, has the ability to improve the system damping as well as voltage profile of the system. A schematic diagram of System with STATCOM at sending end of Line is shown in figure (1).

Two basic controls are implemented in a STATCOM. The first is the a.c voltage regulation of the power system, which is realized by controlling the reactive power interchange between the STATCOM and the power system. The other is the control of the d.c voltage across the capacitor, through

which the active power injection from the STATCOM to the power system is controlled. PI controllers have been found to provide stabilizing controls when the a.c and d.c regulators were designed independently. Some researcher has reported the advantage of two input signals of STATCOM for non linear SMIB system, however very few have reported the advantage of two input signals of STATCOM for linearised model of SMIB system with coordinated action of power system stabilizer (PSS) and power oscillations damping (POD) control.

The advantage of linear model in comparison with non linear model is that the time required for Simulation is less. This paper also presents the coordination of power oscillation damping control (POD) and power system stabilizer (PSS) with the proposed controllers for further improvements in the dynamic performance of the system.

## II. SYSTEM MODEL

The system depicted in Fig. 1 is used to validate the implementation of the proposed controllers for STATCOM. The detailed system data is given in Appendix. Basic stability studies has been conducted on a single machine infinite bus (SMIB) power system installed with STATCOM. The STATCOM is assumed to be based on Pulse Width Modulation (PWM) Converters. The Phillips–Heffron model is established for single machine infinite bus (SMIB) power system installed with STATCOM shown in Fig. 2. Applications of the model established are demonstrated by an example single machine infinite bus power system to investigate the effect of the STATCOM on power system oscillation stability. The configuration comprising transmission line permits the control of real and reactive power flow through a line. The POD control and PSS are described in section IV. For the SMIB system, the STATCOM is located at the sending end of the line, chosen as a typical case.

A. Ms. S.P.Kanojia, Lecturer, Electrical Engineering Department, G.H.Raisoni College of Engineering, Nagpur, India (kanojiasarika@yahoo.co.in).

B. Dr.V.K.Chandrakar, Prof. And Head, Electrical Engineering Department, G.H.Raisoni college of Engineering, Nagpur, India. (vkchandrakar@satyam.net).

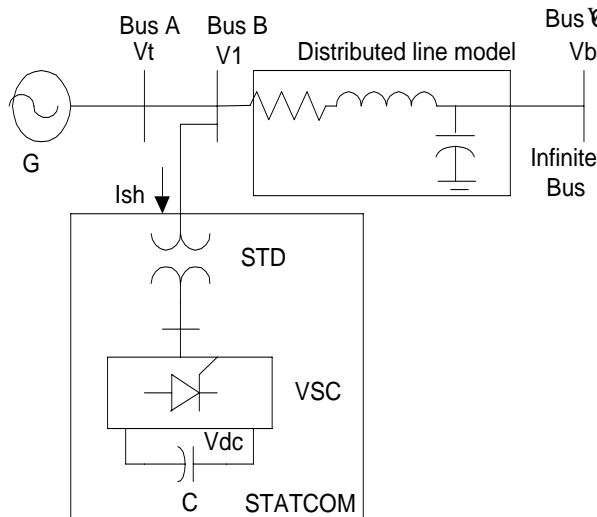

Fig.1 System with STATCOM at sending end of Line

### III. STATCOM MODEL

The main advantage of the power electronics based FACTS controller over mechanical controller is its fast operation. STATCOM is one of the key FACTS controllers [1]. The static synchronous compensator (STATCOM) is based on the principle that a voltage source converter generates a controllable AC voltage source behind a transformer leakage reactance so that the voltage difference across the reactance produces active and reactive power exchange between the STATCOM and the transmission network. For the voltage sourced converter, its ac output voltage is controlled such that it is just right for the required reactive current flow for any ac bus voltage, dc capacitor voltage is automatically adjusted as required to serve as a voltage source for the converter.

Therefore, the capability of STATCOM needs to be exploited not only for voltage control but also to improve damping of the system. STATCOM can be controlled by the voltage magnitude and the phase angle control. Basic stability studies will be conducted on a single machine connected to infinite bus (SMIB) power system. The linearised Phillips-Heffron model which is used for oscillation stability analysis.

#### A. Non-linear dynamic model

A non-linear dynamic model of the system is derived by disregarding the resistances of all the components of the system (generator, transformer, transmission line, shunt converter transformer) and the transients of transformer and transformer of STATCOM and dc capacitor. Fig. 1 is a single machine infinite bus power system installed with a STATCOM which consist of a step-down transformer (SDT) with a leakage reactance  $X_{SDT}$ , a three phase GTO-based voltage source converter (VSC) and a DC capacitor. The VSC generates a controllable AC-voltage source behind a leakage reactance which is given by [2],

$$v_o(t) = V_0 \sin(\omega t - \psi) \quad (1)$$

$$\bar{I}_{Lo} = I_{Lod} + j I_{Loq} \quad (2)$$

$$\bar{V}_0 = c V_{DC} (\cos \psi + j \sin \psi) = c V_{DC} \angle \psi \quad (3)$$

$$\frac{dV_{DC}}{dt} = \frac{I_{DC}}{C_{DC}} = \frac{c}{C_{DC}} (I_{Lod} \cos \psi + I_{Loq} \sin \psi) \quad (4)$$

The voltage difference between the STATCOM-bus AC voltage  $v_L(t)$  and  $v_o(t)$  produces active and reactive power exchange between the STATCOM and the power system, which can be controlled by adjusting the magnitude  $V_0$  and the phase  $\psi$ .

Where, for the PWM inverter,  $c = mk$  and  $k$  is the ratio between AC and DC voltage, depending on the inverter structure;  $m$  is the modulation ratio defined by the PWM; and the phase  $\psi$  is defined by the PWM.

From Fig. 1,

$$\bar{I}_{LB} = \bar{I}_{iL} - \bar{I}_{Lo} = \bar{I}_{iL} - \frac{\bar{V}_L - \bar{V}_0}{j X_{SDT}} \quad (5)$$

$$= \bar{I}_{iL} - \frac{\bar{V}_L - j X_{iL} \bar{I}_{iL} - \bar{V}_0}{j X_{SDT}} \quad (6)$$

Substituting equation (5) into equation (6) it is possible to obtain,

$$I_{iLq} = \frac{V_B \sin \delta + \frac{X_{LB}}{X_{SDT}} c V_{DC} \cos \psi}{X_{iL} + X_{LB} + X_{iL} \frac{X_{LB}}{X_{SDT}} + (1 + \frac{X_{LB}}{X_{SDT}}) X_q} \quad (7)$$

$$I_{iLd} = \frac{E'_q - V_B \cos \delta - \frac{X_{LB}}{X_{SDT}} c V_{DC} \sin \psi}{X_{iL} + X_{LB} + X_{iL} \frac{X_{LB}}{X_{SDT}} + (1 + \frac{X_{LB}}{X_{SDT}}) X_d} \quad (8)$$

The non-linear dynamic model of the system using STATCOM of Fig. 1 is given below:

$$\dot{\delta} = \omega_b \omega \quad (9)$$

$$\dot{\omega} = (P_m - P_e - D \omega) / M \quad (10)$$

$$\dot{E}'_q = (-E'_q + E_{fd}) / T'_{do} \quad (11)$$

$$\dot{E}_{fd} = -\frac{1}{T_A} E_{fd} + \frac{K_A}{T_A} (V_{to} - V_t) \quad (12)$$

Where,

$$P_e = E'_q I_{tLq} + (x_q - x'_d) I_{tLd} I_{tLq} \quad (14)$$

$$E_q = E'_q + (x_d - x'_d) I_{tLd} \quad (15)$$

$$V_t = \sqrt{(E'_q - x'_d I_{tLd})^2 + (x_q I_{tLq})^2}$$

B.Linear dynamic model (modified phillips – heffron model of an SMIB system including STATCOM):

A linear dynamic model is obtained by linearising the non-linear model around an operating point [2]. The linearised model is given below, By linearising above non linear equations,

$$\Delta \dot{\delta} = \omega_b \Delta \omega \quad (16)$$

$$\Delta \dot{\omega} = (-\Delta P_e - D \Delta \omega) / M \quad (17)$$

$$\Delta \dot{E}'_q = (-\Delta E_q + \Delta E_{fd}) / T'_{do} \quad (18)$$

$$\Delta \dot{E}_{fd} = -\frac{1}{T_A} \Delta E_{fd} + \frac{K}{T_A} \Delta V_t \quad (19)$$

Where,

$$\Delta P_e = K_1 \Delta \delta + K_2 \Delta E'_q + K_{pDC} \Delta V_{DC} + K_{pc} \Delta c + K_{p\psi} \Delta \Psi \quad (20)$$

$$\Delta E'_q = K_4 \Delta \delta + K_3 \Delta E'_q + K_{qDC} \Delta V_{DC} + K_{qc} \Delta c + K_{q\psi} \Delta \Psi \quad (21)$$

$$\Delta V_t = K_5 \Delta \delta + K_6 \Delta E'_q + K_{vDC} \Delta V_{DC} + K_{vc} \Delta c + K_{v\psi} \Delta \Psi \quad (22)$$

The linearised model of the power system installed with the STATCOM as,

$$\begin{bmatrix} \Delta \dot{\delta} \\ \Delta \dot{\omega} \\ \Delta \dot{E}'_q \\ \Delta \dot{E}_{fd} \end{bmatrix} = \begin{bmatrix} 0 & \omega_b & 0 & 0 \\ -\frac{K_1}{M} & -\frac{D}{M} & -\frac{K_2}{M} & 0 \\ -\frac{K_4}{T'_{do}} & 0 & -\frac{K_3}{T'_{do}} & \frac{1}{T'_{do}} \\ -\frac{K_A K_5}{T_A} & 0 & -\frac{K_A K_6}{T_A} & -\frac{1}{T_A} \end{bmatrix} \times \begin{bmatrix} \Delta \delta \\ \Delta \omega \\ \Delta E'_q \\ \Delta E_{fd} \end{bmatrix} + \begin{bmatrix} 0 \\ -\frac{K_{pDC}}{M} \\ -\frac{K_{qDC}}{T'_{do}} \\ -\frac{K_A K_{vDC}}{T_A} \end{bmatrix} \Delta V_{DC}$$

$$+ \begin{bmatrix} 0 & 0 \\ \frac{K_{pc}}{M} & -\frac{K_{p\psi}}{M} \\ \frac{K_{qc}}{T'_{do}} & -\frac{K_{q\psi}}{T'_{do}} \\ \frac{K_A K_{vc}}{T_A} & -\frac{K_A K_{v\psi}}{T_A} \end{bmatrix} \begin{bmatrix} \Delta c \\ \Delta \Psi \end{bmatrix} \quad (23)$$

By Denoting,

$$K_p = \begin{bmatrix} \frac{K_{pDC}}{M} \\ \frac{K_{pc}}{M} \\ \frac{K_{p\psi}}{M} \\ \frac{K_{p\psi}}{M} \end{bmatrix} \quad K_q = \begin{bmatrix} \frac{K_{qDC}}{T'_{do}} \\ \frac{K_{qc}}{T'_{do}} \\ \frac{K_{q\psi}}{T'_{do}} \\ \frac{K_{q\psi}}{T'_{do}} \end{bmatrix} \quad K_v = \begin{bmatrix} \frac{K_A K_{vDC}}{T_A} \\ \frac{K_A K_{vc}}{T_A} \\ \frac{K_A K_{v\psi}}{T_A} \\ \frac{K_A K_{v\psi}}{T_A} \end{bmatrix} \quad (24)$$

Where  $\Delta f^* = u$

The linearised model is shown in Fig. (2).

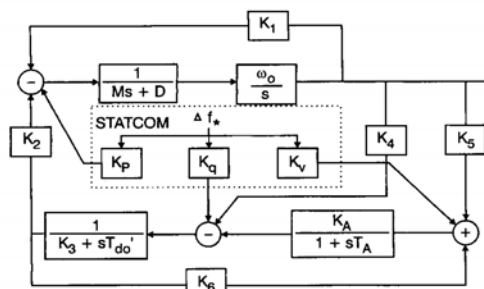

Fig. 2 Phillips- Heffron model of a single machine infinite-bus power system installed with a STATCOM

Hence by linearising the above equations,we can obtain,

$$\Delta \dot{V}_{DC} = K_7 \Delta \delta + K_8 \Delta E'_q + K_9 \Delta V_{DC} + K_{dc} \Delta c + K_{d\psi} \Delta \Psi \quad (25)$$

The full state system model can be obtained as follows,

$$\begin{bmatrix} \Delta \dot{\delta} \\ \Delta \dot{\omega} \\ \Delta \dot{E}'_q \\ \Delta \dot{E}_{fd} \\ \Delta \dot{V}_{dc} \end{bmatrix} = \begin{bmatrix} 0 & \omega_b & 0 & 0 & 0 \\ -\frac{K_1}{M} & -\frac{D}{M} & -\frac{K_2}{M} & 0 & -\frac{K_{pDC}}{M} \\ -\frac{K_4}{T'_{do}} & 0 & -\frac{K_3}{T'_{do}} & \frac{1}{T'_{do}} & -\frac{K_{qDC}}{T'_{do}} \\ -\frac{K_A K_5}{T_A} & 0 & -\frac{K_A K_6}{T_A} & -\frac{1}{T_A} & -\frac{K_A K_{vDC}}{T_A} \\ K_7 & 0 & K_8 & 0 & K_9 \end{bmatrix} \times \begin{bmatrix} \Delta \delta \\ \Delta \omega \\ \Delta E'_q \\ \Delta E_{fd} \\ \Delta V_{dc} \end{bmatrix} + \begin{bmatrix} 0 & 0 \\ \frac{K_{pc}}{M} & -\frac{K_{p\psi}}{M} \\ \frac{K_{qc}}{T'_{do}} & -\frac{K_{q\psi}}{T'_{do}} \\ \frac{K_A K_{vc}}{T_A} & -\frac{K_A K_{v\psi}}{T_A} \\ K_{dc} & K_{d\psi} \end{bmatrix} \begin{bmatrix} \Delta c \\ \Delta \Psi \end{bmatrix} \quad (26)$$

The modified Phillips –Heffron model has 18 constants .These constants are functions of system parameters and the initial operating condition [4].

$$u = [\Delta C, \Delta \phi]^T \quad (27)$$

Where,

$\Delta C$  = Deviation impulse width modulation index of the shunt inverter. By controlling  $m$ , the output voltage of the shunt converter is controlled.

$\Delta \phi$  = Deviation in phase angle of the shunt converter voltage.

*C. Dynamic model in state space form*

The dynamic model of the system in state space form is obtained from the transfer-function

$$\dot{X} = AX + Bu \tag{28}$$

Here the state vector  $X$  is

$$X = [\Delta\delta, \Delta\omega, \Delta E_q', \Delta E_{fd}, \Delta V_{DC}]^T \tag{29}$$

and the control vector  $u$  is

$$u = [\Delta C, \Delta \phi]^T$$

The introduction of STATCOM controllers at an appropriate location does not provide adequate damping, as the primary task of controllers is to control voltage. Hence in order to increase the system damping it is necessary to add an additional control blocks with an appropriate input signals. Thus, following additional control signals are introduced with the main system i.e.,

- 1) POD (Power oscillation Damping)
- 2) PSS (Power System Stabilizers)
- 3) Coordinated action of POD & PSS.

The control strategy considered for the STATCOM is designed by using locally available measurable components of the system under abnormal system conditions.

**IV. POWER SYSTEM OSCILLATION DAMPING CONTROLLER**

A damping controller is provided to improve the damping of power system oscillations. The damping controller be considered as comprising two cascade connected blocks. The speed deviation signal is derived from the difference of measured power at

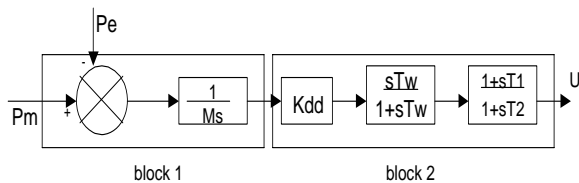

Fig. 3 Transfer function block diagram of the POD

STATCOM location and the set mechanical input power and the error signal is integrated and multiplied by  $1/M$ , where  $M$  is inertia constant of the machine. The second block comprises a lead lag compensator. Figure (4) shows the block diagram of power oscillation damping controller (POD). We can achieve the desired damping ratio of the electromechanical mode and compensate for the phase shift between the control signal and the resulting electrical power deviation.

The Fig. 5 shows the block diagram of power system stabilizer (PSS). The basic function of a power system

stabilizer (PSS) is to add damping to the generator rotor oscillations by controlling its excitation using auxiliary stabilizing signals.

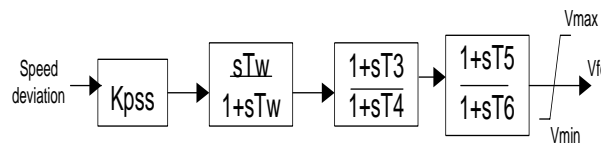

Fig. 4 Transfer function block diagram of the PSS

**V. COORDINATED TUNING OF POD CONTROLLER AND STATCOM CONTROLLER**

In large power systems, damping of power oscillation between interconnected areas is important for the system secure operation. However, using only one controller may not provide sufficient damping for the inter-area oscillations. Hence the introduction of STATCOM controllers does not provide adequate damping, as the primary task of controllers is to control voltage

The STATCOM is installed at sending end of the line of the SMIB system. The STATCOM control system comprises of two controllers:

- 1) STATCOM with dc voltage regulator, i.e. phase angle ' $\psi$ ' which is defined by PWM converter.
- 2) STATCOM with ac voltage regulator, i.e. modulation index ' $m$ ' and it also defined by PWM converter.

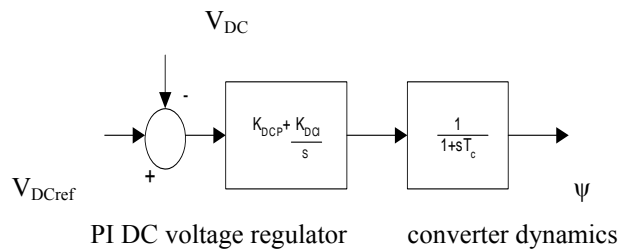

Fig. 5 STATCOM dynamic model of DC-Voltage regulator with the PWM Converter

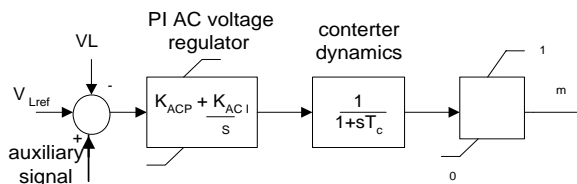

Fig. 6 STATCOM dynamic model of AC Voltage regulator and stabilizer (with PWM converter)

**VI. SIMULATION RESULTS**

Digital simulation is carried out by the MATLAB software. For the simulation, different loading conditions with different fault locations in the SMIB system are considered.

The results of the proposed controllers with POD and PSS and the dynamic response for  $\Delta\omega$  of the system at sending end of the line are shown in Figure (7). The results demonstrate that the satisfactory performance of controllers under different loading conditions and fault locations. The coordinated effect of POD and PSS further improves the dynamic performance of the system than conventional PI controller. The results clearly shows that the dynamic performance of the system using additional power oscillation damping controller is superior to that obtained without STATCOM. Peak of speed deviation in the case STATCOM with additional power oscillation damping controller (POD) alone is 0.00094 and oscillations are settled in 1.25 seconds. Peak of speed deviation in the case without STATCOM is 0.00338 and oscillations are settled in 1.4 seconds. This shows that the STATCOM with additional damping controller gives better dynamic stability performance and is very much effective in damping oscillations. No. of oscillations are less and the settling time is also less.

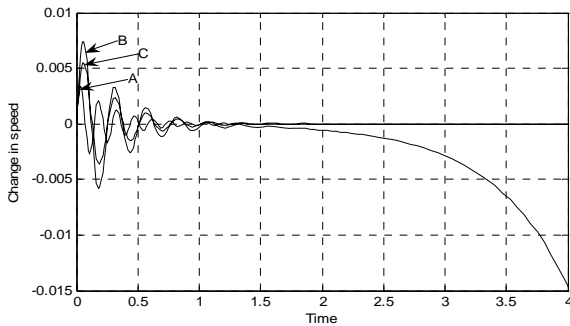

Fig. 7 Dynamic response for  $\Delta\omega$   
a) without STATCOM  
b) with STATCOM dc voltage regulator  
c) with STATCOM ac voltage regulator

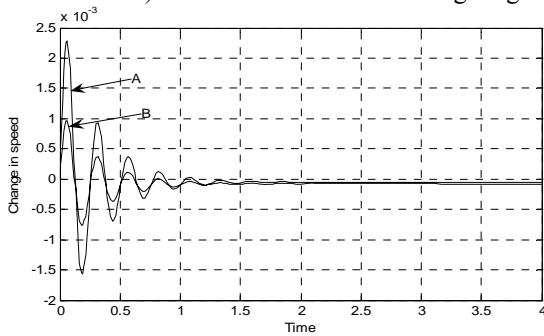

Fig. 8 Dynamic response for  $\Delta\omega$   
a) STATCOM with PSS controller  
b) STATCOM with POD controller

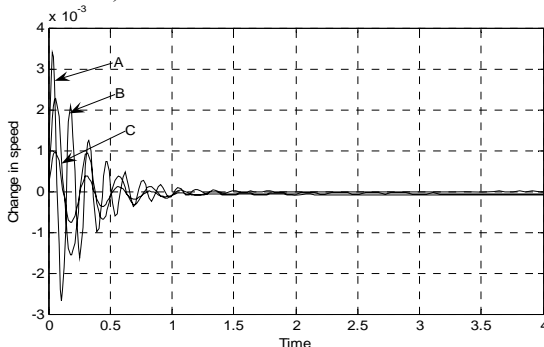

Fig. 9 Dynamic response for  $\Delta\omega$

a) without STATCOM  
b) STATCOM with PSS controller  
c) STATCOM with POD controller

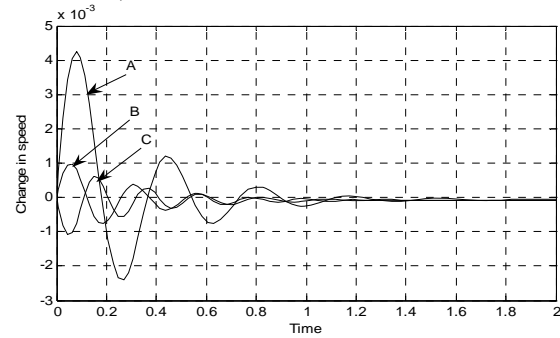

Fig. 10 Dynamic response for  $\Delta\omega$  for different values of  
of  
a) Pe=0.5, b) Pe=1.0 c) Pe=1.5

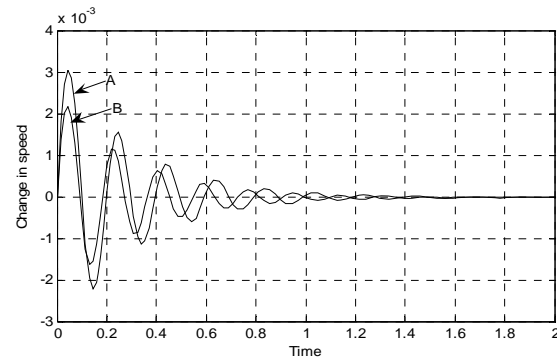

Fig. 11 Dynamic response of  $\Delta\omega$  for STATCOM with additional power oscillation damping controller for different values of  $X_e$   
a)  $X_e=0.3$  b)  $X_e=0.65$

## VII. CONCLUSION

This paper presents a design of PI based STATCOM controller in a single machine infinite bus system for the dynamic stability improvements. The results indicate that the coordinated action of POD and PSS with proposed controller provides further improvement in dynamic performance under different loading conditions. At STATCOM location, damping signal (POD) prove to be more feasible solution than PSS.

## VIII. APPENDIX

SMIB system data (in p. u.):  
 $G: M=2H=0.6, D=4.0, T_{do}'=5.044, V_{B0}=1$  p.u.  
 Exc.System:  $K_a=10.0, T_a=0.01s$   
 STATCOM:  $K_{pd}=-0.1931, K_{qd}=-0.5388, K_{vd}=0.2730, K_{p\psi}=0.0321, K_{q\psi}=0.106819, K_{v\psi}=273, K_{pu}=0.0633, K_{qu}=-0.215265, K_{vu}=-548.6$   
 POD:  $K_s=10.0, T_w=10.0s, T_1=0.9s, T_2=0.1s, T_3=0.7s, T_4=0.2s$   
 PSS:  $K_{pss}=12.0, T_w=10.0s, T_1=2.5s, T_2=0.75s, T_3=2.2s, T_4=0.9s$   
 Constants:  $K_1=0.9849, K_2=9.0896, K_3=2.442, K_4=0.1792, K_5=-0.0476, K_6=0.3514, K_7=-0.2697, K_8=0.2061, K_9=0.0397$

REFERENCES

- [1] N.G Hingorani, L. Gyugyi, "Understanding FACTS: Concepts and Technology of Flexible AC Transmission Systems", IEE power engineering society, IEEE press, Delhi 2001.
- [2] H. Wang, F., "Phillips- Heffron model of power system installed with STATCOM and applications." IEE Proc.,Gener. Transm.Distrib., vol.146, No. 5, September 1999
- [3] H. Wang, F. Li, "Multivariable sampled regulators for the coordinated control of STATCOM ac and dc voltage,"IEE,Proc.Gen.Tran.Dist.,Vol.147,No.2,2000,pp.93-98.
- [4] A.H.M.A. Rahim, M.F.Kandlawala, "Robust STATCOM voltage controller design using loop shaping technique," Electric power system Research, Vol. 68, 2004, pp.61-74.
- [5] V.K.Chandrakar, A.G.Kothari, "Fuzzy-based Static Synchronous Compensator (STATCOM) for improving transient stability performance". 692 Int. J.Energy Technology and Policy,Vol.5,No.6,2007.