

# An Adaptive Setting of Frequency Relay with Consideration on Load and Power System Dynamics

J. Mirzaei, and H. Kazemi Kargar

**Abstract**—This paper presents a new approach for setting frequency relays based on the dynamic of power system. A simplified model of the power system based on the load-frequency control loop will be developed to be used instead of the complete model of the power system. The effects of the equipments and their responses on the frequency variations of the power plant will be investigated and then a method for adaptive settings of frequency relays will be explained. The proposed method will be investigated by analyzing a simplified model of a power plant by MATLAB software.

**Keywords**—Adaptive Settings, Frequency Relay (FR), Power System Dynamics, SFR model.

## I. INTRODUCTION

ACTIVE power imbalance is detected from its effect on velocity or frequency of machine. Frequency deviation (deviation of frequency) from its nominal value is selected as a signal for exciting automatic control system. Active power variation depends on power angle ( $\delta$ ) and is independent of bus voltage.  $\delta$  Angle changes due to the variation of velocity and frequency of machine. Thus, active power, power angle and frequency are controlled in same channel that is known as a Pf channel. Corresponded control system is known as automatic load – frequency control system (LFC).

Many researchers have studied frequency model of power plant during the last 50 years and even before that. This model is derived by neglecting from some parts of power plant such as electrical parts that have too low time constants about tenth seconds and their responses in dynamics interactions vanish rapidly.

System frequency response is sensitive to variations of corresponding parameters such as variations in consumer load power, Governor Droop, Inertia constant, Reheat time constant, produced power of High-pressure turbine and damping factor [1,2,3].

In mentioned references, these variations were surveyed without considering LFC loop that results the system doesn't

reach the synchronous frequency or in the other words non-zero steady state error again. In this paper, mentioned variations are surveyed again, considering the LFC loop)

Frequency relay is used for frequency control and system stability. In the load increments times and totally reduction of frequency, the task of this relay is unnecessary load shedding, vice versa in the load decrements times, this relay reduces the produced power by power plants and prevents the frequency to go up [4]. Already, these relays settings are done tentatively and no special criterions are for calculating theirs settings. With considering to load and system dynamics and variation in frequency response due to their effects, a new adaptive method for relay setting can be presented.

This paper is organized as follows. The principle of a turbine-governor model for steam power plant is presented in Section II. Section III describes the different parameters effects on the amplitude and settling time of frequency variations with considering to frequency control loop and estimates a sheath for encompass the all of them. Circumstances of the frequency relay setting is illustrated in Section IV. Section V proposes a new adaptive method for setting of the frequency relay of a reheat turbine-generator power plant with considering to load and power system dynamics and effective parameters on frequency response.

In this paper some abbreviations are used, which presented in Table I.

TABLE I  
ABBREVIANS OF POWER PLANT SYSTEMS

$F_H$	Rated Output Power of HP Turbine
R	Governor Droop
H	Inertia Constant
D	Damping Factor
$T_R$	Reheat Time Constant
$K_I$	Coefficient of Frequency Control Loop

## II. SYSTEM FREQUENCY RESPONSE MODEL

System Frequency response model (SFR) is based on neglecting nonlinearities and all but the largest time constants in the equations of the generating units of the power system, with the added assumption that the generation is dominated by reheat steam turbine generators. This means that the generating unit inertia and reheat time constants predominate the system average frequency response. Moreover, since only two time constants predominate, the resulting system response can be computed in closed form, thereby providing a simple,

J. Mirzaei is with the MAPNA GROUP (Iran Power Plant Projects Management Co., <http://www.mapna.com>), Tehran, Iran. He received Bsc and MSc in power engineering in Zanjan University (ZNU), Zanjan, Iran (corresponding author to provide phone: +98-21-81962734; fax: +98-21-88777394; e-mail: jaber.mirzaei@gmail.com).

H. Kazemi Kargar was with Zanjan University, Zanjan, Iran. He is now with the Electrical and Computer Department, Shahid Beheshti University (SBU), Tehran, Iran (e-mail: hkazemi@sbu.ac.ir).

but fairly accurate, method of estimating the essential characteristics of the system frequency response [1].

Fig. 1 presents a complete model of power plant for dynamics studies with all of time constants and load-frequency control loop.

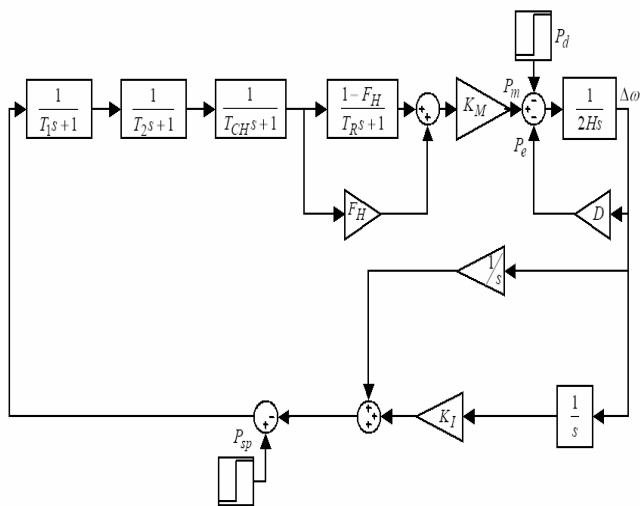

Fig. 1 Typical Reheat Turbine Governor Model

Transfer function of block-diagram shown in Fig. 1 is obtained as:

$$\frac{\Delta\omega}{P_d} = \frac{as^5 + bs^4 + cs^3 + ds^2 + es}{as^6 + \beta s^5 + \gamma s^4 + \eta s^3 + \mu s^2 + \vartheta} \quad (1)$$

where:

- $a = T_1 T_2 T_{CH} R T_R$
- $b = R T_1 T_2 T_{CH} + R T_R (T_1 T_2 + T_{CH} (T_1 + T_2))$
- $c = R [T_1 T_2 + T_{CH} (T_1 + T_2)] + (T_1 + T_2 + T_{CH}) R T_R$
- $d = R (T_1 + T_2 + T_{CH}) + R T_R$
- $e = R$
- $\alpha = 2aH$
- $\beta = 2bH + aD$
- $\gamma = 2cH + bD$
- $\eta = 2eH + dD + K_m F_H T_R$
- $\mu = K_m F_H T_R K_I R + DR + K_m$
- $\vartheta = K_m K_I R$

Note that, since the time constants of an automatic voltage regulator (AVR), an excitation system, field and the damper windings of the generator are much smaller than those of turbines-governors in LFC loop, their transient responses decay much faster and do not affect the LFC loop [7,8]. Consequently, the dynamics of these components are not included in the linearized power system model.

Now, if with consideration of characteristic equation that derived from (1), traces the root locus of the system, Fig. 2 will yield. By using predominant poles theory the resulting system response can be computed in closed form, thereby providing a simple, but fairly accurate, method of estimating the essential characteristics of the system frequency response. Predominant poles corresponding to system depicted in Fig. 3.

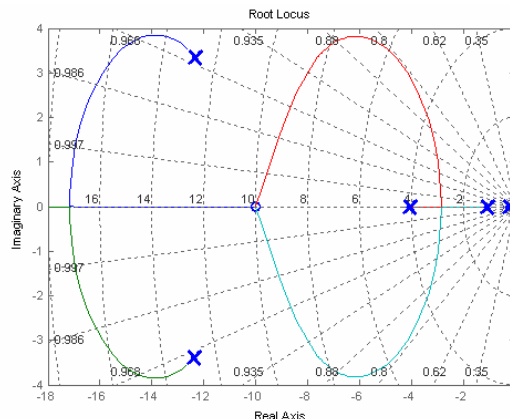

Fig. 2 Corresponding root locus of power plant model

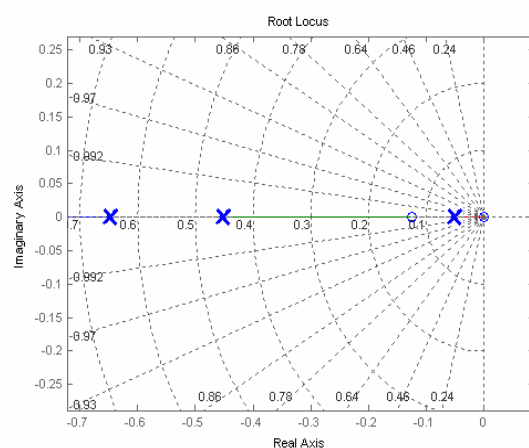

Fig. 3 Predominant poles locus

By tend attention to predominant poles locus and elimination beyond poles, simple model of power plant is obtained that depicted in Fig. 4.

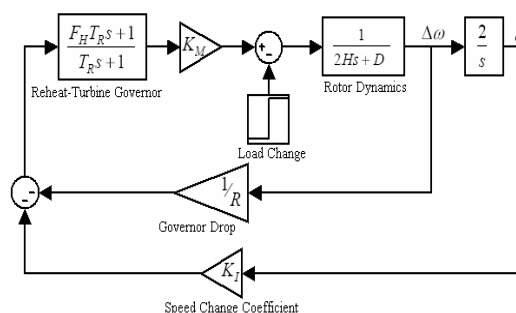

Fig. 4 Simplified Model of Power Plant with Disturbance Input

Transfer function of above block-diagram yielded as follow:

$$\frac{\Delta\omega}{P_d} = \frac{RT_R s^2 + Rs}{Xs^3 + Ys^2 + Zs + K_I R} \quad (2)$$

Where:

$$X = 2RT_R H$$

$$Y = 2RH + RT_R D + K_m F_H T_R$$

$$Z = K_m F_H T_R K_I R + DR + K_m$$

### III. LOAD AND SYSTEM DYNAMICS

Variation of the system frequency response due to change into the system and load parameters such as load consumed power, governor droop, inertia constant, reheat time constants, produced power of HP turbine and damping factor is surveyed in [1], but in this reference due to regardless of speed change coefficient in LFC system, steady state error has non-zero value and system doesn't comeback to synchronous frequency after disturbance. Here with adding the feedback torque angle, in addition to steady state error, amplitude of frequency deviation in transient state is reduced and system stability is increased.

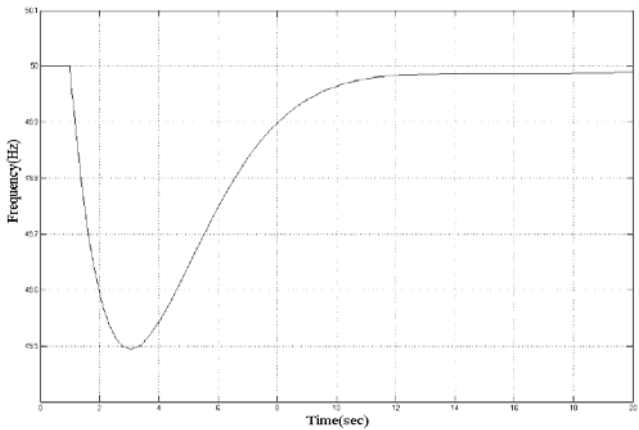

Fig. 5 System Frequency Response to Step Disturbance Input

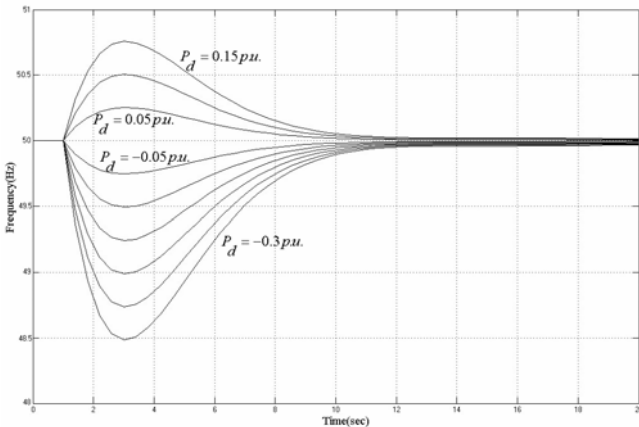

Fig. 6 Frequency Response for Varying Values of  $P_d$  (-0.3-0.15 p.u)

Fig. 5 presented frequency response of studied system for 0.2 p.u. over load. Values of power plant parameters for studied power system are shown in Table II.

Variations of load and power plant parameters that generally occurred due to a large load injection or rejection or power plant age, some variations is created in system frequency response [1].

TABLE II  
 TYPICAL POWER PLANT PARAMETERS

$F_H$	0.3	$T_R$	8 sec
$D$	1	$H$	4 sec
$K_I$	2	$K_m$	0.95
$R$	0.05		

Figs. 6 to 11 presented the variations of system frequency response with change into mentioned parameters.

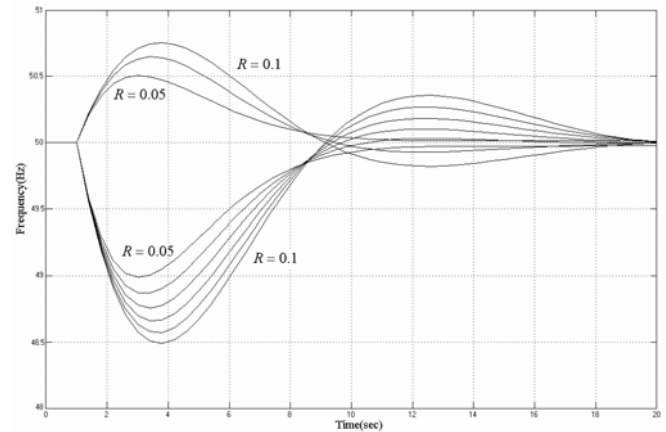

Fig. 7 Frequency Response for Varying Values of  $R$  (0.05-0.1)

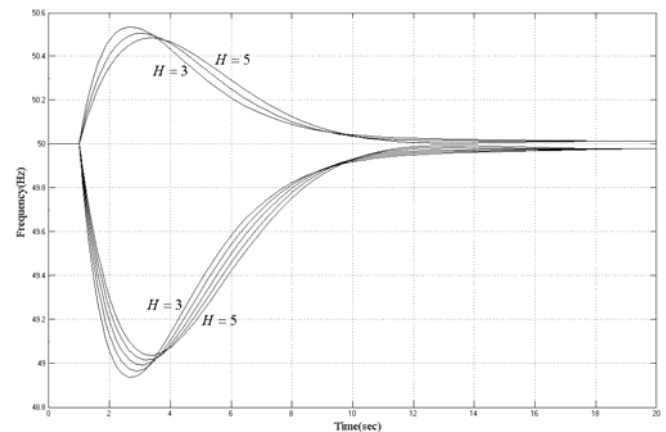

Fig. 8 Frequency Response for Varying Values of  $H$  (3-5)

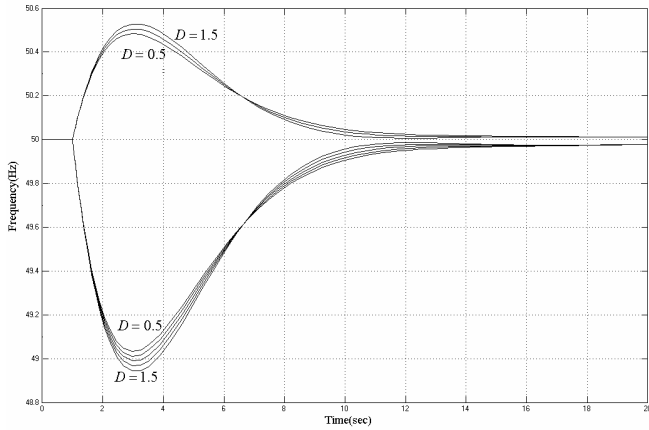

Fig. 9 Frequency Response for Varying Values of D (0.5-1.5)

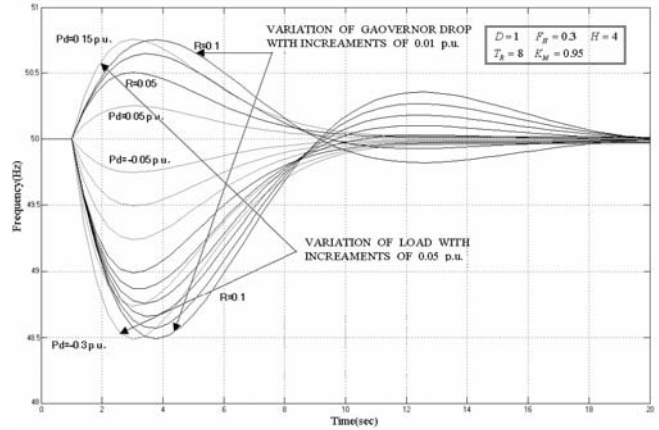

Fig. 12 System Frequency Response with Consideration on Load and Governor Droop

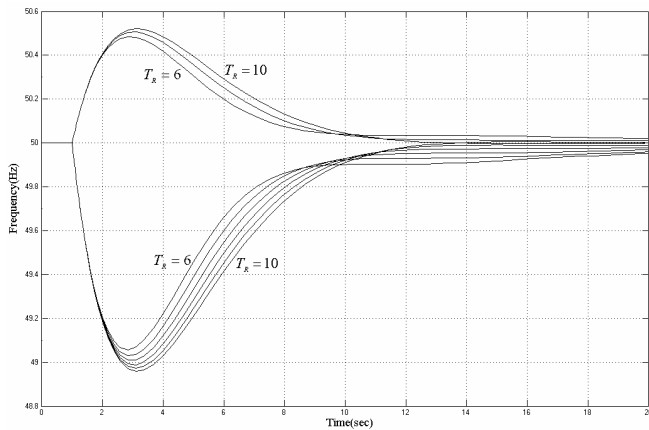

Fig. 10 Frequency Response for Varying Values of Ts (6-10 sec)

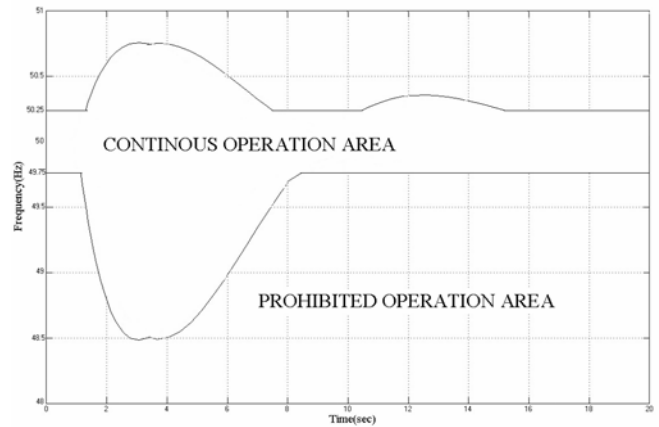

Fig. 13 Sheath of System Frequency Response with Consideration on Load and Governor Droop

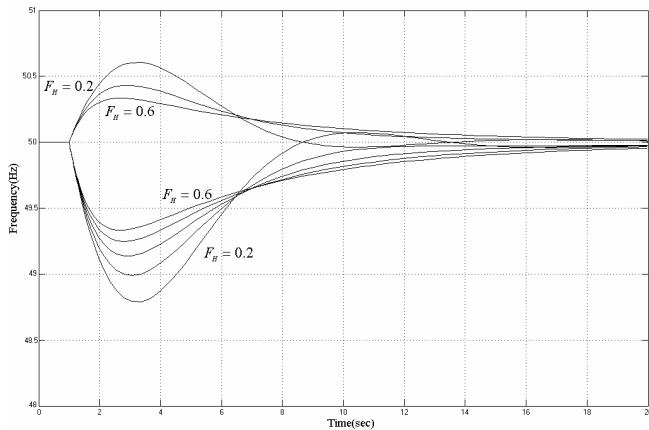

Fig. 11 Frequency Response for Varying Values of FH (0.2-0.6)

Analyzing the diagrams shown in Fig. 6 presented that the sheath of the variations of the system frequency response with considering on only overload and governor droop and elimination the other parameters, same as that shown in Figs. 12 and 13 depicted this sheath for frequency relay setting.

#### IV. FREQUENCY RELAY SETTING

For frequency relay setting, the information about system dynamics must be give to operator to do this setting by using this information and network stability problem. But already, these relays' setting is done tentatively and without considering to network variations, thus inaccuracy in these settings can carry out unnecessary and bi time tripping by relay. For improve this problem and improve network operation proposed adaptive method for these relay settings.

#### V. PROPOSED METHOD FOR FREQUENCY RELAY SETTING

In this paper load and system dynamics that variations of frequency response with variations of them presented in Fig. 8, essential paragon for frequency relay setting. Frequency relay that has studied in this paper, has six setting steps and has capability of frequency deviation setting and the time of these deviations [3]. This relay setting is done with consideration of standard IEC 60034-1 [5]. Figs. 9 and 10 presented that how these steps settings are done.

With considering to shown setting in Fig. 10 the value of frequency deviation and permissive time for this deviation obtained from (3, 4):

$$\Delta f_{reliable} = f_{up} - f_0 \quad (3)$$

$$\Delta t_{reliable} = t_{up} - t_0 \quad (4)$$

Obtained values from these equations are presented in Table III. Same as we expected permissive deviation value in primary steps considering to large ramp of variations, is larger and permissive time of these deviations is smaller. This means that relay able to permit to system that has identified deviations for a special time and relay doesn't tripped.

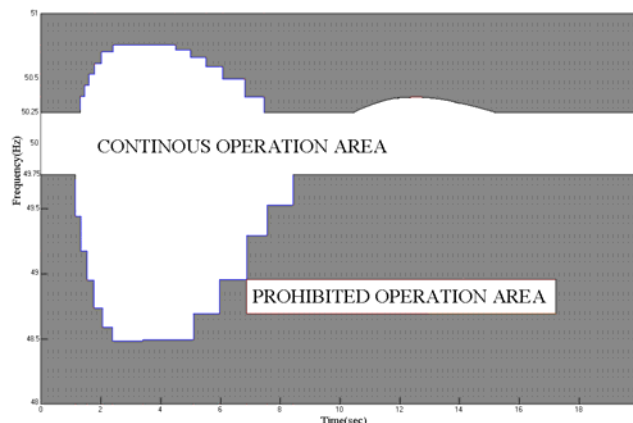

Fig. 14 Six Steps Setting Corresponding Frequency Relay

TABLE III  
FREQUENCY RELAY SETTING FOR STUDIED POWER SYSTEM

Under Frequency Part					
Rising Steps			Falling Steps		
Step	Frequency Deviation(Hz)	Time(sec)	Step	Frequency Deviation(Hz)	Time(sec)
1	0.11	0.75	1	-0.3	0.15
2	0.20	0.60	2	-0.28	0.17
3	0.25	0.50	3	-0.25	0.18
4	0.31	0.50	4	-0.17	0.25
5	0.29	0.70	5	-0.14	0.3
6	0.20	0.75	6	-0.13	0.4
Over Frequency Part					
Rising Steps			Falling Steps		
Step	Frequency Deviation(Hz)	Time(sec)	Step	Frequency Deviation(Hz)	Time(sec)
1	0.12	0.15	1	-0.04	0.75
2	0.12	0.17	2	-0.05	0.60
3	0.07	0.18	3	-0.07	0.50
4	0.05	0.25	4	-0.09	0.50
5	0.06	0.3	5	-0.11	0.70
6	0.08	0.4	6	-0.14	0.75

## VI. CONCLUSION

In this paper proposed an adaptive method for setting frequency relay of typical power system, that rather than usual method has more accuracy. In proposed method first, variations of system frequency response with variation of power plant and load parameters such as load consumed power, governor droop, inertia constant, reheat time constant, produced power of HP turbine and damping factor are evaluated, then considering to obtained diagrams, set the steps of frequency relay that estimates corresponding diagram with good accuracy. Advantage of this method rather than usual method is that in this method, power system has intelligent behavior and for sudden variations parameters of load and power plant that is no requirement to forced outage of power plant or load shedding, no trip order is issuance.

## REFERENCES

[1] P. M. Anderson, M. Mirheydar, 'A Low-Order System Frequency Response Model', IEEE Transaction on Power Systems, Vol. 5, No. 3, pp.720-728, August 1990.

[2] P. M. Anderson, M. Mirheydar, 'An Adaptive Method for Setting Under frequency Load Shedding Relays', IEEE Transaction on Power Systems, Vol. 7, No. 2, pp. 647-655, may 1992.

[3] M.Mashayekh, SH.Jadid," Calculating the Corrective Factor of Frequency Relays in the Initial Step of Network Emergency Load Shedding", 21th International Power System Conference, Iran, Nov 2006, pp:185-192

[4] "Type 81 One and Two Step Frequency Relays", ABB Power T&D Company, Inc. June, 1994

[5] 'C37.106TM' ,IEEE Guide for Abnormal Frequency Protection for Power Generating Plants, IEEE Power Engineering Society,27 February 2004

[6] IEC 60034-1:1999, "Rotating Electrical Machines—Part 1: Rating and Performance". 11 West 42nd Street, 13th Floor, New York, NY 10036, USA.1999.

[7] A. Kazemi, "Electric Power Systems Analysis", publication center of Iran University of Science and Technology, fifth edition, 2003

[8] P. M. Anderson, A. A. Fouad, "Power System Control and Stability" 2nd edition, A JOHN WILEY & SONS, 2003

[9] Elgerd, O.L. "Electric Energy Systems Theory, an Introduction" 2nd edition, McGraw-hill, 1985.



**J. Mirzaei** was born on September 21<sup>st</sup>, 1982 in Malayer, Iran. He received a BSc. degree from Zanjan University of Zanjan in Power Engineering in July 2006. He received his MSc. Degree in Power Engineering from the same university in January 2009. His area of focus is in power systems with research interests in distribution generation.