

# A PSO-based SSSC Controller for Improvement of Transient Stability Performance

Sidhartha Panda, N. P. Padhy

**Abstract**—The application of a Static Synchronous Series Compensator (SSSC) controller to improve the transient stability performance of a power system is thoroughly investigated in this paper. The design problem of SSSC controller is formulated as an optimization problem and Particle Swarm Optimization (PSO) Technique is employed to search for optimal controller parameters. By minimizing the time-domain based objective function, in which the deviation in the oscillatory rotor angle of the generator is involved; transient stability performance of the system is improved. The proposed controller is tested on a weakly connected power system subjected to different severe disturbances. The non-linear simulation results are presented to show the effectiveness of the proposed controller and its ability to provide efficient damping of low frequency oscillations. It is also observed that the proposed SSSC controller improves greatly the voltage profile of the system under severe disturbances.

**Keywords**—Particle swarm optimization, transient stability, power system oscillations, SSSC.

## I. INTRODUCTION

WHEN large power systems are interconnected by relatively weak tie lines, low frequency oscillations are observed. These oscillations may sustain and grow to cause system separation if no adequate damping is available [1]. Recent development of power electronics introduces the use of flexible ac transmission system (FACTS) controllers in power systems. FACTS controllers are capable of controlling the network condition in a very fast manner and this feature of FACTS can be exploited to improve the stability of a power system [2]. Static Synchronous Series Compensator (SSSC) is one of the important members of FACTS family which can be installed in series in the transmission lines. With the capability to change its reactance characteristic from capacitive to inductive, the SSSC is very effective in controlling power flow in power systems [3]. An auxiliary stabilizing signal can also be superimposed on the power flow control function of the SSSC so as to improve power system oscillation stability

[4]. The applications of SSSC for power oscillation damping, stability enhancement and frequency stabilization can be found in several references [5]-[8]. The influence of degree of compensation and mode of operation of SSSC on small disturbance and transient stability is also reported in the literature [9]-[11]. Most of these proposals are based on small disturbance analysis that required linearization of the system involved. However, linear methods cannot properly capture complex dynamics of the system, especially during major disturbances. This presents difficulties for tuning the FACTS controllers in that the controllers tuned to provide desired performance at small signal condition do not guarantee acceptable performance in the event of major disturbances.

A conventional lead-lag controller structure is preferred by the power system utilities because of the ease of on-line tuning and also lack of assurance of the stability by some adaptive or variable structure techniques. The problem of FACTS controller parameter tuning is a complex exercise. A number of conventional techniques have been reported in the literature pertaining to design problems of conventional power system stabilizers namely: the eigenvalue assignment, mathematical programming, gradient procedure for optimization and also the modern control theory. Unfortunately, the conventional techniques are time consuming as they are iterative and require heavy computation burden and slow convergence. In addition, the search process is susceptible to be trapped in local minima and the solution obtained may not be optimal [12].

Recently, Particle Swarm Optimization (PSO) technique appeared as a promising algorithm for handling the optimization problems. PSO is a population based stochastic optimization technique, inspired by social behaviour of bird flocking or fish schooling [13]. PSO shares many similarities with Genetic Algorithm (GA); like initialization of population of random solutions and search for the optimal by updating generations. However, unlike GA, PSO has no evolution operators such as crossover and mutation. One of the most promising advantages of PSO over GA is its algorithmic simplicity as it uses a few parameters and easy to implement. In PSO, the potential solutions, called particles, fly through the problem space by following the current optimum particles [14]. In view of the above, PSO is employed in the present work to optimally tune the parameters of the SSSC controller.

In this paper, a comprehensive assessment of the effects of

Sidhartha Panda is a research scholar in the Department of Electrical Engineering, Indian Institute of Technology, Roorkee, Uttaranchal, 247667, India. (e-mail: speeddee@iitr.ernet.in, panda\_sidhartha@rediffmail.com).

N.P.Padhy is Associate Professor in the Department of Electrical Engineering, IIT, Roorkee, India. (e-mail: nppeefee@iitr.ernet.in.)

SSSC controller has been carried out. The design problem of SSSC-based controller is transformed into an optimization problem. The design objective is to improve the transient stability performance of a single-machine-infinite-bus power system, subjected to severe disturbances. PSO based optimal tuning algorithm is used to optimally tune the parameters of the SSSC controller. The proposed controller has been applied and tested on a weakly connected power system under different severe disturbances.

## II. POWER SYSTEM UNDER STUDY

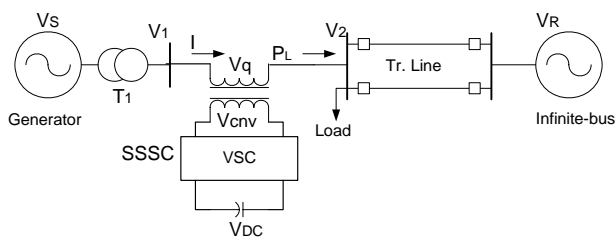

Fig. 1 Single-machine infinite bus power system with SSSC

The single-machine infinite-bus power system shown in Fig. 1 is considered in this study. The system comprises a generator connected to an infinite bus through a step-up transformer and a SSSC followed by a double circuit transmission line. In the figure  $T_1$  represents the transformer;  $V_S$  and  $V_R$  are the generator terminal and infinite bus voltage respectively;  $V_1$  and  $V_2$  are the bus voltages;  $V_{DC}$  and  $V_{cnv}$  are the DC voltage source and output voltage of the SSSC converter respectively;  $I$  is the line current and  $P_L$  is the real power flow in the transmission lines.

### A. Overview of SSSC and its Control System

A SSSC is a solid-state voltage source inverter, which generates a controllable AC voltage source, and connected in series to power transmission lines in a power system. The injected voltage ( $V_q$ ) is in quadrature with the line current  $I$ , and emulates an inductive or a capacitive reactance so as to influence the power flow in the transmission lines [3]. The compensation level can be controlled dynamically by changing the magnitude and polarity of  $V_q$  and the device can be operated both in capacitive and inductive mode.

The single-line block diagram of control system of SSSC is shown in Fig. 2 [15]. The control system consists of:

- A phase-locked loop (PLL) which synchronizes on the positive-sequence component of the current  $I$ . The output of the PLL ( $\theta = \omega t$ ) is used to compute the direct-axis and quadrature-axis components of the AC three-phase voltages and currents (labeled as  $V_d$ ,  $V_q$  or  $I_d$ ,  $I_q$  on the diagram).
- Measurement systems measuring the q components of AC positive-sequence of voltages  $V_1$  and  $V_2$  ( $V_{1q}$  and  $V_{2q}$ ) as well as the DC voltage  $V_{dc}$ .
- AC and DC voltage regulators which compute the two

components of the converter voltage ( $V_{dcnv}$  and  $V_{qcnv}$ ) required to obtain the desired DC voltage ( $V_{dcref}$ ) and the injected voltage ( $V_{qref}$ ).

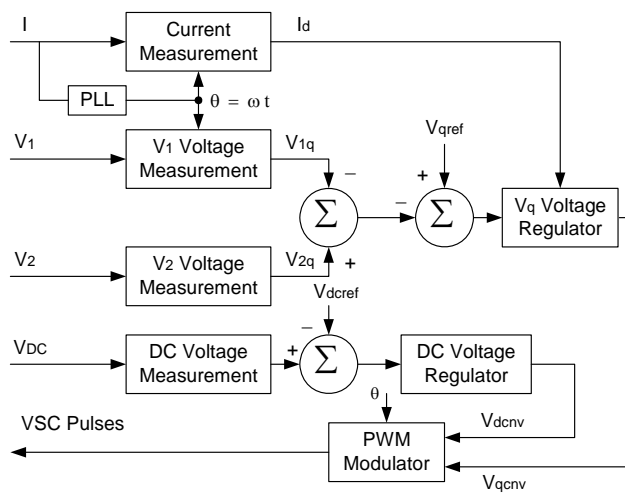

Fig. 2 Single line diagram of the control system of SSSC

The variation of injected voltage is performed by means of a Voltage-Sourced Converter (VSC) connected on the secondary side of a coupling transformer. The VSC uses forced-commutated power electronic devices (e.g. GTOs, IGBTs or IGCTs) to synthesize a voltage  $V_{cnv}$  from a DC voltage source. A capacitor connected on the DC side of the VSC acts as a DC voltage source. In the control system block diagram  $V_{dcnv}$  and  $V_{qcnv}$  designate the components of converter voltage  $V_{cnv}$  which are respectively in phase and in quadrature with line current  $I$ . VSC using IGBT-based PWM inverters is used in the present study. However, as details of the inverter and harmonics are not represented in power system stability studies, a GTO-based model can also be used. This type of inverter uses Pulse-Width Modulation (PWM) technique to synthesize a sinusoidal waveform from a DC voltage with a typical chopping frequency of a few kilohertz. Harmonics are cancelled by connecting filters at the AC side of the VSC. This type of VSC uses a fixed DC voltage  $V_{dc}$ . The converter voltage  $V_{cnv}$  is varied by changing the modulation index of the PWM modulator.

## III. THE PROPOSED APPROACH

### A. Structure of SSSC Controller

The structure of SSSC controller, to modulate the SSSC injected voltage  $V_q$ , is shown in Fig. 3. The input signal of the proposed controller is the same speed deviation ( $\Delta\omega$ ), and the output signal is the injected voltage  $V_q$ . The structure consists of a gain block with gain  $K_S$ , a signal washout block and two-stage phase compensation blocks as shown in Fig. 3. The signal washout block serves as a high-pass filter, with the time constant  $T_W$ , high enough to allow signals associated with oscillations in input signal to pass unchanged. From the viewpoint of the washout function, the value of  $T_W$  is not

critical and may be in the range of 1 to 20 seconds [1]. The phase compensation block (time constants  $T_1$ ,  $T_2$  and  $T_3$ ,  $T_4$ ) provides the appropriate phase-lead characteristics to compensate for the phase lag between input and the output signals.

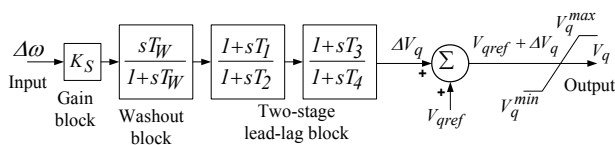

Fig. 3 Structure of SSSC-based controller

In the Fig. 3  $V_{qref}$  represents the reference injected voltage as desired by the steady state power flow control loop. The steady state power flow loop acts quite slowly in practice and hence, in the present study  $V_{qref}$  is assumed to be constant during large disturbance transient period. The desired value of compensation is obtained according to the change in the SSSC injected voltage  $\Delta V_q$  which is added to  $V_{qref}$ .

### B. Problem Formulation

The transfer function of the SSSC-based controller is:

$$U_{SSSC} = K_S \left( \frac{sT_W}{1+sT_W} \right) \left( \frac{1+sT_1}{1+sT_2} \right) \left( \frac{1+sT_3}{1+sT_4} \right) y \quad (1)$$

Where,  $U_{SSSC}$  and  $y$  are the input and output signals of the SSSC-based controller respectively. In this structure, the washout time constants  $T_W$  and the time constants  $T_2$ ,  $T_4$  are usually prespecified. In the present study,  $T_W=10s$  and  $T_2 = T_4 = 0.3 s$  are used. The controller gain  $K_S$  and the time constants  $T_1$  and  $T_3$  are to be determined. During steady state conditions  $\Delta V_q$  and  $V_{qref}$  are constant. During dynamic conditions the series injected voltage  $V_q$  is modulated to damp system oscillations. The effective  $V_q$  in dynamic conditions is:

$$V_q = V_{qref} + \Delta V_q \quad (2)$$

### C. Optimization Problem

It is worth mentioning that the SSSC-based controller is designed to minimize the power system oscillations after a large disturbance so as to improve the power system stability. These oscillations are reflected in the deviations in power angle, rotor speed and line power. Minimization of any one or all of the above deviations could be chosen as the objective. In the present study the objective function is expressed as follows:

$$J = \sum \int_0^t |\Delta\omega(t, X)| dt \quad (3)$$

In the above equations,  $\Delta\omega(t, X)$  denotes the rotor speed deviation for a set of controller parameters  $X$  (note that here  $X$

represents the parameters to be optimized;  $K_S, T_1, T_3$ ; the parameters of the SSSC controller), and  $t_1$  is the time range of the simulation. With the variation of the parameters  $X$ , the  $\Delta\omega(t, X)$  will also be changed. For objective function calculation, the time-domain simulation of the power system model is carried out for the simulation period. It is aimed to minimize this objective function in order to improve the system response in terms of the settling time and overshoots.

In this study, it is aimed to minimize the proposed objective function  $J$ . The problem constraints are the SSSC controller parameter bounds. Therefore, the design problem can be formulated as the following optimization problem:

$$\text{Minimize } J \quad (4)$$

Subject to

$$K_S^{min} \leq K_S \leq K_S^{max} \quad (5)$$

$$T_{1S}^{min} \leq T_{1S} \leq T_{1S}^{max} \quad (6)$$

$$T_{3S}^{min} \leq T_{3S} \leq T_{3S}^{max} \quad (7)$$

Tuning a controller parameter can be viewed as an optimization problem in multi-modal space as many settings of the controller could be yielding good performance. Traditional method of tuning doesn't guarantee optimal parameters and in most cases the tuned parameters needs improvement through trial and error. In PSO based method, the tuning process is associated with an optimality concept through the defined objective function and the time domain simulation. The designer has the freedom to explicitly specify the required performance objectives in terms of time domain bounds on the closed loop responses. Hence the PSO methods yield optimal parameters and the method is free from the curse of local optimality. In view of the above, the proposed approach employs PSO to solve this optimization problem and search for optimal set of SSSC-based damping controller parameters.

## IV. OVERVIEW OF PSO TECHNIQUE

The PSO method is a member of wide category of Swarm Intelligence methods for solving the optimization problems. It is a population based search algorithm where each individual is referred to as particle and represents a candidate solution. Each particle in PSO flies through the search space with an adaptable velocity that is dynamically modified according to its own flying experience and also the flying experience of the other particles. In PSO each particles strive to improve themselves by imitating traits from their successful peers. Further, each particle has a memory and hence it is capable of remembering the best position in the search space ever visited by it. The position corresponding to the best fitness is known as  $pbest$  and the overall best out of all the particles in the population is called  $gbest$  [13]-[14].

The features of the searching procedure can be summarized as follows [16]:

- Initial positions of  $pbest$  and  $gbest$  are different. However, using the different direction of  $pbest$  and  $gbest$ , all agents gradually get close to the global optimum.
- The modified value of the agent position is continuous and the method can be applied to the continuous problem. However, the method can be applied to the discrete problem using grids for XY position and its velocity.
- There are no inconsistency in searching procedures even if continuous and discrete state variables are utilized with continuous axes and grids for XY positions and velocities. Namely, the method can be applied to mixed integer nonlinear optimization problems with continuous and discrete state variables naturally and easily.
- The above concept is explained using only XY axis (2 dimensional space). However, the method can be easily applied to n dimensional problem.

The modified velocity and position of each particle can be calculated using the current velocity and the distance from the  $pbest_{j,g}$  to  $gbest_g$  as shown in the following formulas [17]:

$$v_{j,g}^{(t+1)} = w * v_{j,g}^{(t)} + c_1 * r_1 * (pbest_{j,g} - x_{j,g}^{(t)}) + c_2 * r_2 * (gbest_g - x_{j,g}^{(t)}) \quad (8)$$

$$x_{j,g}^{(t+1)} = x_{j,g}^{(t)} + v_{j,g}^{(t+1)} \quad (9)$$

Where  $j = 1, 2, \dots, n$  and  $g = 1, 2, \dots, m$

$n$  = number of particles in a group;

$m$  = number of members in a particle;

$t$  = number of iterations (generations);

$v_{j,g}^{(t)}$  = velocity of particle  $j$  at iteration  $t$ ,

$$\text{with } v_g^{min} \leq v_{j,g}^{(t)} \leq v_g^{max};$$

$w$  = inertia weight factor;

$c_1, c_2$  = cognitive and social acceleration factors respectively;

$r_1, r_2$  = random numbers uniformly distributed in the range (0, 1);

$x_{j,g}^{(t)}$  = current position of  $j$  at iteration  $t$ ;

$pbest_j$  =  $pbest$  of particle  $j$ ;

$gbest$  =  $gbest$  of the group.

The  $j$ -th particle in the swarm is represented by a  $g$ -dimensional vector  $x_j = (x_{j,1}, x_{j,2}, \dots, x_{j,g})$  and its rate of position change (velocity) is denoted by another  $g$ -dimensional vector  $v_j = (v_{j,1}, v_{j,2}, \dots, v_{j,g})$ . The best previous position of the  $j$ -th particle is represented as  $pbest_j = (pbest_{j,1}, pbest_{j,2}, \dots, pbest_{j,g})$ . The index of best particle among all of the particles in the group is represented by the  $gbest_g$ . In PSO, each particle moves in the search space with a velocity according to its own previous best solution and its group's previous best solution. The velocity update in a PSO consists of three parts; namely momentum, cognitive and social parts. The balance among these parts determines the performance of a PSO algorithm. The parameters  $c_1$  &  $c_2$  determine the relative pull of  $pbest$  and  $gbest$  and the parameters  $r_1$  &  $r_2$  help in stochastically varying these pulls. In the above equations, superscripts denote the iteration number. Fig. 4 shows the velocity and position updates of a particle for a two-dimensional parameter space.

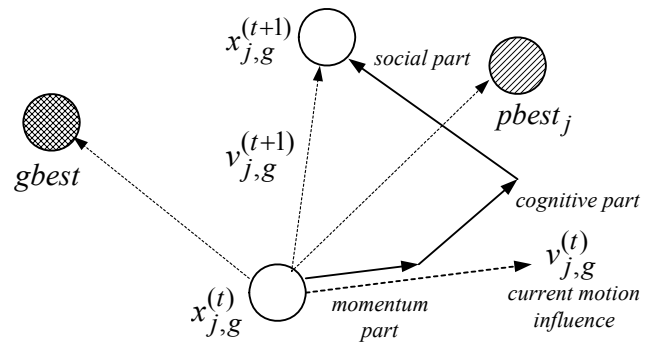

Fig. 4 Deception of velocity and position updates in particle swarm optimization technique

## V. RESULTS AND DISCUSSIONS

The SimPowerSystems (SPS) toolbox is used for all simulations and SSSC-based damping controller design. SPS is a MATLAB-based modern design tool that allows scientists and engineers to rapidly and easily build models to simulate power systems using Simulink environment. The SPS's main library, *powerlib*, contains models of typical power equipment such as machines, governors, excitation systems, transformers, lines and FACTS devices. The library also contains the Powergui block that opens a graphical user interface for the steady-state analysis of electrical circuits. The Load Flow and Machine Initialization option of the Powergui block performs the load flow and the machines initialization [15].

In order to optimally tune the parameters of the PSS and SSSC damping controller, as well as to assess their performance and robustness under wide range of operating conditions with various fault disturbances and fault clearing sequences, the test system depicted in Fig. 1 is considered for analysis. The model of the example power system shown in Fig. 1, is developed using SimPowerSystems blockset. The system consists of a of 2100 MVA, 13.8 kV, 60Hz hydraulic

generating unit, connected to a 300 km long double-circuit transmission line through a 3-phase 13.8/500 kV step-up transformer and a 100 MVA SSSC. The generator is equipped with Hydraulic Turbine & Governor (HTG) and Excitation system. All the relevant parameters are given in appendix.

*A. Application of PSO*

For the purpose of optimization of equation (3), routines from PSO toolbox [18] are used. The objective function is evaluated for each individual by simulating the example power system, considering a severe disturbance. For objective function calculation, a three phase short-circuit fault in one of the parallel transmission lines is considered. The computational flow chart of PSO algorithm is shown in Fig. 5.

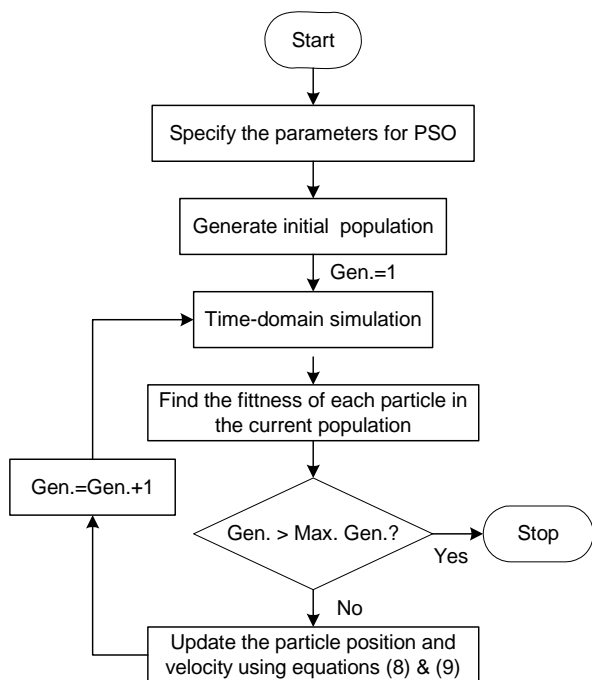

Fig. 5 Flowchart of particle swarm optimization algorithm

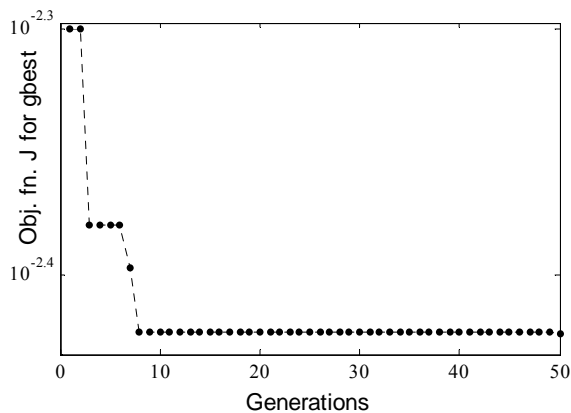

Fig. 6 Convergence of objective function for *gbest*

While applying PSO, a number of parameters are required to be specified. An appropriate choice of these parameters affects the speed of convergence of the algorithm. Table I shows the specified parameters for the PSO algorithm. Optimization is terminated by the prespecified number of generations. The optimization was performed with the total number of generations set to 50. The convergence rate of objective function *J* for *gbest* with the number of generations is shown in Fig. 6. Table II shows the optimal values of SSSC-based controller parameters obtained by the PSO algorithm.

TABLE I  
PARAMETERS USED FOR PSO ALGORITHM

PSO parameters	Value/Type
Swarm size	20
No. of Generations	50
<i>c1, c2</i>	2.0, 2.0
<i>w<sub>start</sub>, w<sub>end</sub></i>	0.9, 0.4

TABLE II  
OPTIMIZED SSSC-BASED CONTROLLER  
PARAMETERS OBTAINED BY PSO ALGORITHM

$K_S$	$T_1$	$T_3$
65.732	0.5527	0.2639

*B. Simulation Results*

To assess the effectiveness and robustness of the proposed controllers, simulation studies are carried out for various fault disturbances and fault clearing sequences. The behavior of the proposed controller under transient conditions is verified by applying a 6-cycle three-phase fault at *t* = 1 sec, at the middle of the one transmission line. The fault is cleared by permanent tripping of the faulted line. The system response under this severe disturbance is shown in Figs. 7 (a)-(f). The response without control (no control) and response with PSO optimized SSSC-based controller are shown in the figures with legends NC and PS respectively.

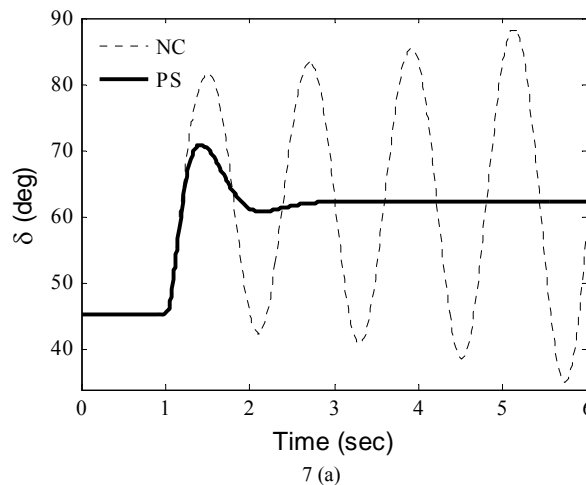

7 (a)

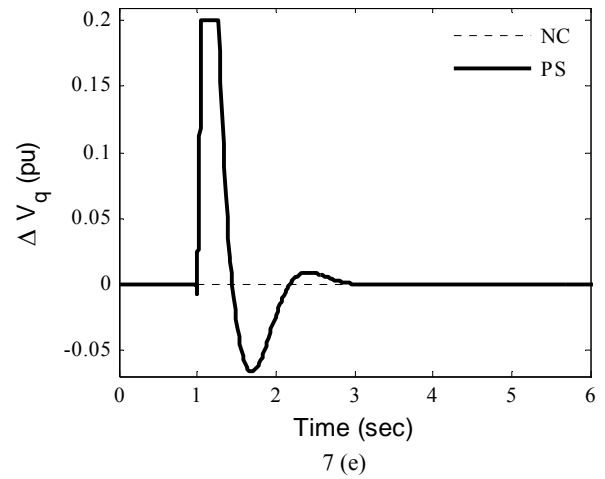
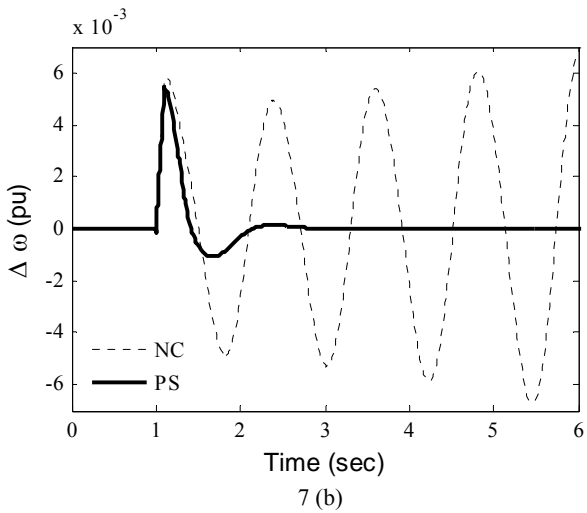

Open Science Index, Electrical and Computer Engineering Vol:1, No:9, 2007 publications.waset.org/3661.pdf

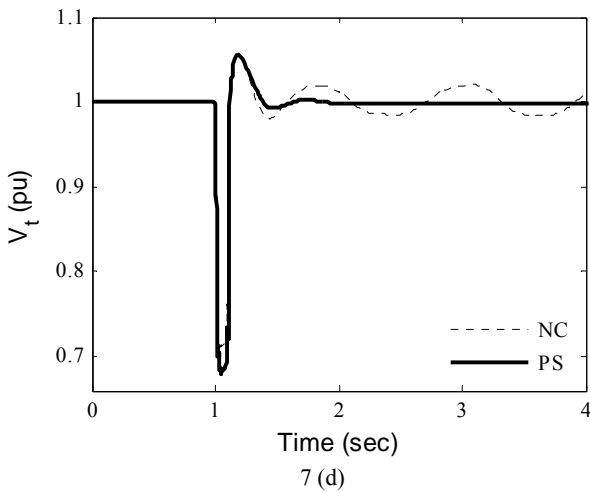
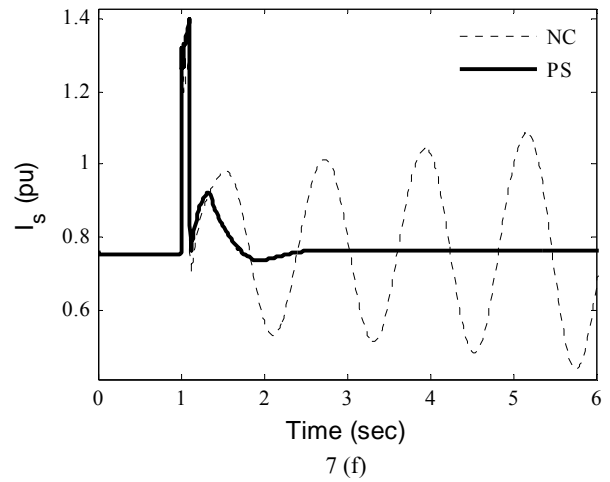
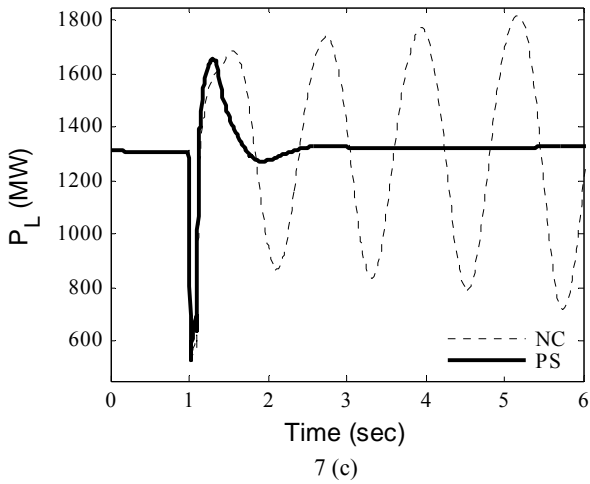
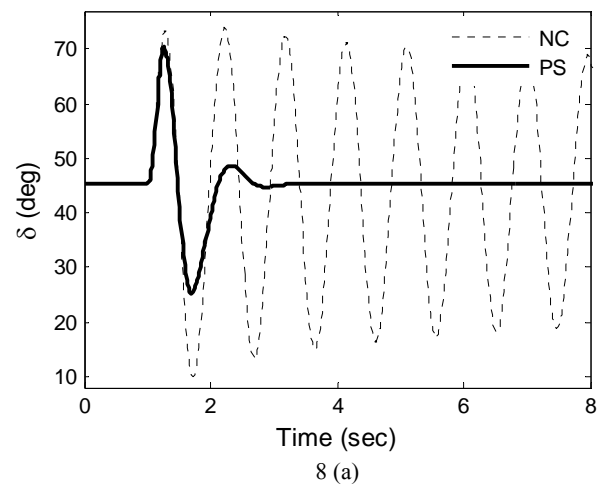
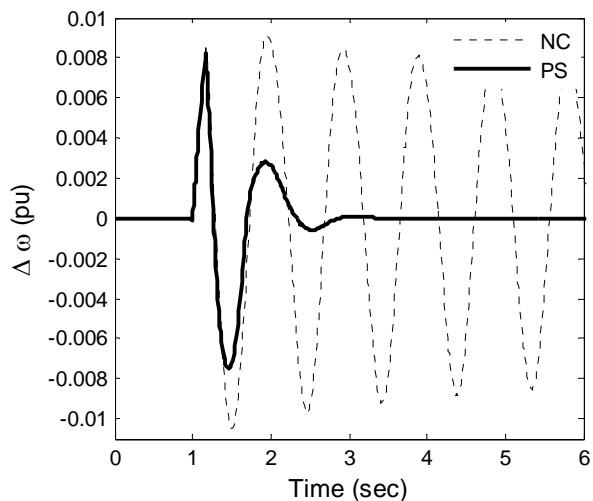

Fig. 7 System response for a 6-cycle 3-phase fault disturbance cleared by permanent tripping of one line. (a) power angle:  $\delta$ , deg (b) speed deviation:  $\Delta\omega$ , pu (c) line power:  $P_L$ , MW (d) terminal voltage:  $V_t$ , pu (e) SSSC controller injected voltage deviation:  $\Delta V_q$  (f) stator current: pu.



It is clear from the Figures that, the system is unstable without control under this severe disturbance. It can also be seen that, SSSC-based controller significantly suppresses the first swing in the rotor angle and provides good damping characteristics to low frequency oscillations by stabilizing the system much faster.



8 (b)

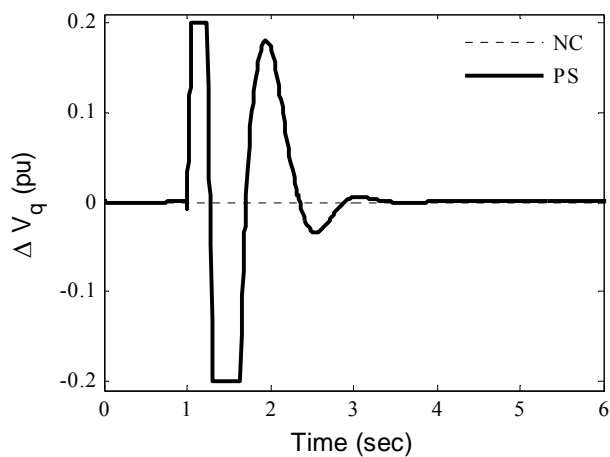

8 (e)

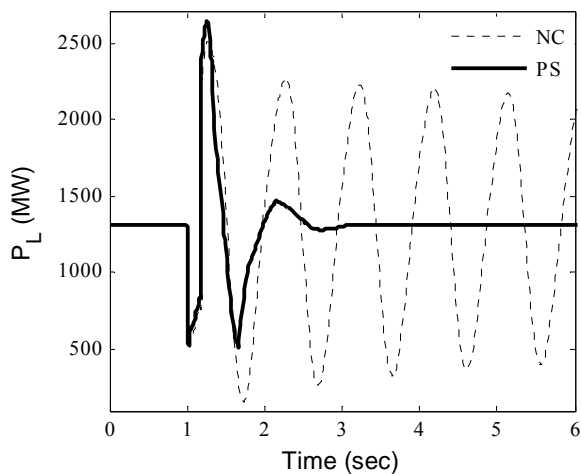

8 (c)

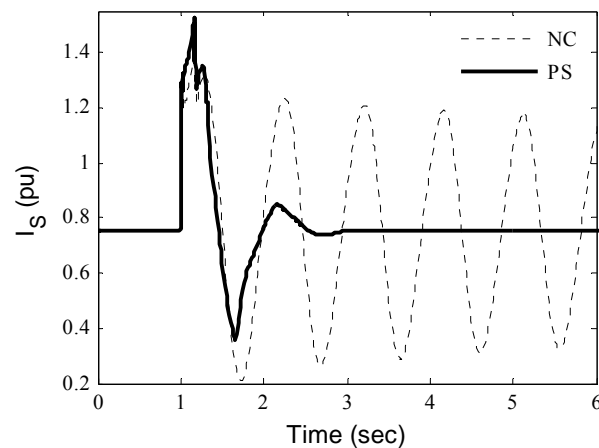

8 (f)

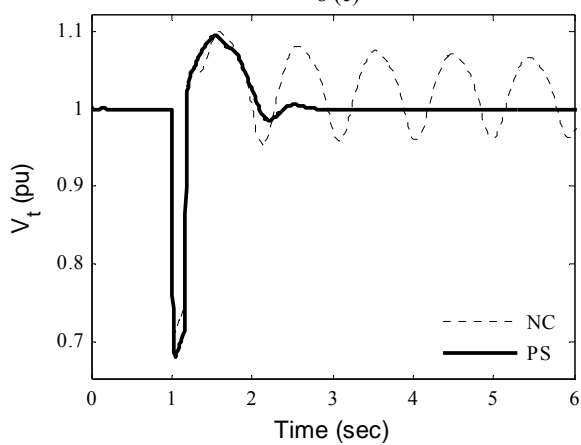

8 (d)

Fig. 8 System response for a 10-cycle self-clearing 3-phase fault disturbance. (a) power angle:  $\delta$ , deg (b) speed deviation:  $\Delta\omega$ , pu (c) line power:  $P_L$ , MW (d) terminal voltage:  $V_t$ , pu (e) SSSC controller injected voltage deviation:  $\Delta V_q$  (f) stator current: pu.

It can be seen that, the system is oscillatory without control for the above contingency. It is also clear from the Figs. that the proposed PSO optimized SSSC controller has good damping characteristics to low frequency oscillations and stabilizes the system quickly.

## VI. CONCLUSION

In this paper, transient stability performance improvement by a SSSC controller is presented. For the proposed controller design problem, a non-linear simulation-based objective function to increase the system damping was developed. Then, the particle swarm optimization technique was implemented to search for the optimal controller parameters. The effectiveness of the proposed SSSC controller for improving transient stability performance of a power system and its design by the methods proposed in the paper are demonstrated by a weakly connected example power system subjected to different severe disturbances. The non-linear simulation results show the

effectiveness of the proposed controller and their ability to provide good damping of low frequency oscillations. In addition, the effectiveness of the proposed SSSC controller to suppress power system oscillations and to improve the system voltage profile under different severe disturbances are also shown. It can be concluded that the proposed SSSC controller extend the power system stability limit by enhancing the system damping.

#### APPENDIX

A complete list of parameters used appears in the default options of SimPowerSystems in the User's Manual [15]. All data are in pu unless specified otherwise.

- 1) *Generator*  
 $S_B = 2100$  MVA,  $H = 3.7$  s,  $V_B = 13.8$  kV,  $f = 60$  Hz,  $P_{eo} = 0.75$ ,  $V_{to} = 1.0$ ,  $\delta_0 = 41.51^\circ$ ,  $R_S = 2.8544 \times 10^{-3}$ ,  $X_d = 1.305$ ,  $X_d' = 0.296$ ,  $X_d'' = 0.252$ ,  $X_q = 0.474$ ,  $X_q' = 0.243$ ,  $X_q'' = 0.18$ ,  $T_d = 1.01$  s,  $T_d' = 0.053$  s,  $T_{qo} = 0.1$  s.
- 2) *Hydraulic Turbine and Governor*  
 $K_a = 3.33$ ,  $T_a = 0.07$ ,  $G_{min} = 0.01$ ,  $G_{max} = 0.97518$ ,  $V_{gmin} = -0.1$  pu/s,  $V_{gmax} = 0.1$  pu/s,  $R_p = 0.05$ ,  $K_p = 1.163$ ,  $K_i = 0.105$ ,  $K_d = 0$ ,  $T_d = 0.01$  s,  $\beta = 0$ ,  $T_w = 2.67$  s
- 3) *Excitation System*  
 $T_{LP} = 0.02$  s,  $K_a = 200$ ,  $T_a = 0.001$  s,  $K_c = 1$ ,  $T_e = 0$ ,  $T_b = 0$ ,  $T_c = 0$ ,  $K_f = 0.001$ ,  $T_f = 0.1$  s,  $E_{fmin} = 0$ ,  $E_{fmax} = 7$ ,  $K_p = 0$
- 4) *Transformer*  
 $2100$  MVA,  $13.8/500$  kV,  $60$  Hz,  $R_1 = 0.002$ ,  $L_1 = 0$ ,  $D_1/Y_g$  connection,  $R_m = 500$ ,  $L_m = 500$
- 5) *Transmission line*  
 $3$ -Ph,  $60$  Hz, Length =  $300$  km each,  $R_1 = 0.02546 \Omega/\text{km}$ ,  $R_0 = 0.3864 \Omega/\text{km}$ ,  $L_1 = 0.9337 \times 10^{-3}$  H/km,  $L_0 = 4.1264 \times 10^{-3}$  H/km,  $C_1 = 12.74 \times 10^{-9}$  F/km,  $C_0 = 7.751 \times 10^{-9}$  F/km
- 6) *SSSC*  
 $S_{nom} = 100$  MVA,  $V_{nom} = 500$  kV,  $f = 60$  Hz,  
 $V_{qmax} = 0.2$ , Max rate of change of  $V_{qref} = 3/s$ ,  $R_{env} = 0.00533$ ,  $L_{env} = 0.16$ ,  $V_{DC} = 40$  kV,  $C_{DC} = 375 \times 10^{-6}$  F,  
 $K_{P\_IVR} = 0.00375$ ,  $K_{I\_IVR} = 0.1875$ ,  $K_{P\_Vdcr} = 0.1 \times 10^{-3}$ ,  $K_{P\_Vdcr} = 20 \times 10^{-3}$

#### REFERENCES

- [1] P. Kundur, "Power system stability and control", McGraw-Hill, 1994.
- [2] N. G. Hingorani and L. Gyugyi, "Understanding FACTS: concepts and technology of flexible AC transmission systems", IEEE Press, New York, 2000.
- [3] L. Gyugyi, C. D. Schauder and K. K. Sen, "Static synchronous series compensator: a solid-state approach to the series compensation of transmission lines," *IEEE Transactions on Power Delivery*, vol. 12, no. 1, pp. 406-17, Jan. 1997.
- [4] H. F. Wang, "Static synchronous series compensator to damp power system oscillations," *Electric Power Systems Research*, vol. 54, pp. 113-119, 2000.
- [5] K R Padiyar and K Uma Rao, "Discrete control of series compensation for stability improvement in power systems," *Electrical Power & Energy Systems*, vol. 19, no. 5, pp. 311-319, 1997.
- [6] R. Mihalic and I. Papic, "Static synchronous series compensator—a mean for dynamic power flow control in electric power systems," *Electric Power Systems Research*, vol. 45, pp. 65-72, 1998.
- [7] D. Menniti, A. Pinnarelli, N. Scordino and N. Sorrentino, "Using a FACTS device controlled by a decentralised control law to damp the transient frequency deviation in a deregulated electric power system," *Electric Power Systems Research*, vol. 72 pp. 289-298, 2004.

- [8] I. Ngamroo, J. Tippayachai and S. Dechanupaprittha, "Robust decentralised frequency stabilisers design of static synchronous series compensators by taking system uncertainties into consideration," *Electrical Power and Energy Systems* vol. 28, pp. 513-524, 2006.
- [9] F. A. R. Al Jowder and B. T. Ooi, "Series Compensation of Radial Power System by a Combination of SSSC and Dielectric Capacitors," *IEEE Transactions on Power Delivery*, vol. 20, no. 1, pp. 458-465, January 2005.
- [10] F. A. R. Al Jowder, "Influence of Mode of Operation of the SSSC on the Small Disturbance and Transient Stability of a Radial Power System," *IEEE Transactions on Power Systems*, vol. 20, no. 2, pp. 935-942, May 2005.
- [11] M.S. Castro, H.M. Ayres, V.F. da Costa and L.C.P. da Silva, "Impacts of the SSSC control modes on small-signal transient stability of a power system," *Electric Power Systems Research*, vol. 77, pp. 1-9, 2007.
- [12] Y.L. Abdel-Magid and M.A. Abido, "Robust coordinated design of excitation and TCSC-based stabilizers using genetic algorithms," *International Journal of Electrical Power & Energy Systems*, vol. 69, no. 2-3, pp. 129-141, 2004.
- [13] J. Kennedy and R.C. Eberhart, "Particle swarm optimization", Proc. IEEE Int'l. Conf. on Neural Networks, IV, 1942-1948. Piscataway, NJ, IEEE Service Center, 1995.
- [14] PSO Tutorial, <http://www.swarmintelligence.org/tutorials.php>
- [15] SimPowerSystems 4.3 User's Guide, Available: <http://www.mathworks.com/products/simpower/>
- [16] J. Kennedy and R. Eberhart, *Swarm intelligence*, Academic press, 1st ed. San Diego, CA., 2001.
- [17] Z.L. Gaing, "A particle swarm optimization approach for optimum design of PID controller in AVR system", *IEEE Transaction on Energy Conversions*, vol. 9, no. 2, pp. 384-391, 2004.
- [18] B. Birge, "Particle swarm optimization toolbox", Available: <http://www.mathworks.com/matlabcentral/fileexchange/>

**Sidhartha Panda** received the M.E. degree in Power Systems Engineering from University College of Engineering, Burla, Sambalpur University, India in 2001. Currently, he is a Research Scholar in Electrical Engineering Department of Indian Institute of Technology Roorkee, India. He was an Associate Professor in the Department of Electrical and Electronics Engineering, VITAM College of Engineering, Andhra Pradesh, India and Lecturer in the Department of Electrical Engineering, SMIT, Orissa, India. His areas of research include power system transient stability, power system dynamic stability, FACTS, optimization techniques, distributed generation and wind energy.

**Narayana Prasad Padhy** was born in India and received his Degree (Electrical Engineering), Masters Degree (Power Systems Engineering) with Distinction and Ph.D., Degree (Power Systems Engineering) in the year 1990, 1993 and 1997 respectively in India. Then he has joined the Department of Electrical Engineering, Indian Institute of Technology (IIT) India, as a Lecturer, Assistant Professor and Associate Professor during 1998, 2001 and 2006 respectively. Presently he is working as an Associate Professor in the Department of Electrical Engineering, Indian Institute of Technology (IIT) India. He has visited the Department of Electronics and Electrical Engineering, University of Bath, UK under Boyscast Fellowship during 2005-06. His area of research interest is mainly Power System Privatization, Restructuring and Deregulation, Transmission and Distribution network charging, Artificial Intelligence Applications to Power System and FACTS.