

Behavioral Study of TCSC Device – A MATLAB/Simulink Implementation

¹S. Meikandasivam, ²Rajesh Kumar Nema, ³Shailendra Kumar Jain

Abstract—A basic conceptual study of TCSC device on Simulink is a teaching aid and helps in understanding the rudiments of the topic. This paper thus stems out from basics of TCSC device and analyzes the impedance characteristics and associated single & multi resonance conditions. The Impedance characteristics curve is drawn for different values of inductance in MATLAB using M-files. The study is also helpful in estimating the appropriate inductance and capacitance values which have influence on multi resonance point in TCSC device. The capacitor voltage, line current, thyristor current and capacitor current waveforms are discussed briefly as simulation results. Simulink model of TCSC device is given and corresponding waveforms are analyzed. The subsidiary topics e.g. power oscillation damping, SSR mitigation and transient stability is also brought out.

Keywords—TCSC device, Impedance characteristics, Resonance point, Simulink model

I. INTRODUCTION

RAPID increase in power demand according to forecast made in 17th Electrical power Survey India[11], will rise to peak value of 152746MW by 2011-12, that is more than the double of 75,756 MW, what was required in 2003. This cannot be achieved by installing new power station and erecting more transmission line in the scheduled period of forecast. To meet rising demand of power, FACTS devices are introduced in the transmission line to enhance its power transfer capability; either in series or in shunt. The series compensation are an economic method of improving power transmission capability of the lines [1][2][4]. Note it is not possible to compromise the 2011-12th demand, but meanwhile for installing and erecting periods.

Series compensation will:

- Increase power transmission capability.
- Improve system stability.
- Reduce system losses.
- Improve voltage profile of the lines.
- Optimize power flow between parallel lines.

Thyristor-controlled series capacitors (TCSC) is also a type of series compensator, can provide many benefits for a power system including controlling power flow in the line, damping power oscillations, and mitigating subsynchronous resonance.

The TCSC concept is that it uses an extremely simple main circuit. The capacitor is inserted directly in series with the transmission line and the thyristor-controlled inductor is mounted directly in parallel with the capacitor. Thus no interfacing equipment like e.g. high voltage transformers is required. This makes TCSC much more economic than some other competing FACTS technologies. Thus it makes TCSC simple and easy to understand the operation.

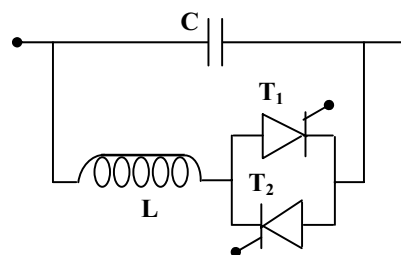

Fig. 1A simple diagram of TCSC device

World's first 3 phase [5], 2 X 165 MVAR, TCSC was installed in 1992 in Kayenta substation, Arizona. It raised the transmission capacity of transmission line by 30%, but it was soon realized that the device is also a very effective means for providing damping of electromechanical power oscillations. A third possible application of TCSC emerged from the on site observations that it can provide series compensation without causing the same risk for sub-synchronous resonance (SSR) as a fixed series capacitor. World's first TCSC for subsynchronous resonance (SSR) mitigation was installed in Stode, Sweden in 1998, by ABB. Specifically this period makes a valiant period for TCSC and makes the researchers to turn on to TCSC

The main purpose of this paper is to furnish a concise study of TCSC in simple way. Section II, brings out the operation of TCSC along with numerical equations. Section III gives an impedance characteristics curve of a TCSC device and specifies the range of inductance and capacitance region. In section IV and V deals, condition for single & multiple resonance points theoretically and evaluate by simulation. Also finds a suitable value of inductance and capacitance. Section VI analyzes the different waveforms in the capacitive region of TCSC with Simulink model. Finally it carries some of additional benefits of TCSC device along with power system in last section.

¹Rsh scholar, MANIT, Bhopal, India (e-mail: meikandasivams@gmail.com).

²Assistant professor MANIT, Bhopal, India (e-mail: rk_nema@yahoo.com).

³Assistant professor MANIT, Bhopal, India (e-mail: sjain68@gmail.com).

II. OPERATION OF TCSC [1,2]

The basic operation of TCSC can be easily explained from circuit analysis. It consists of a series compensating capacitor shunted by a Thyristor controlled reactor (TCR). TCR is a variable inductive reactor X_L (figure 2) controlled by firing angle α . Here variation of X_L with respect to α is given by

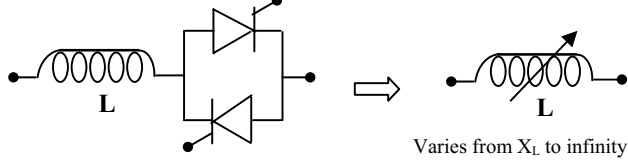

Fig:2 Equivalent circuit of TCR

$$X_L(\alpha) = X_L \frac{\pi}{\pi - 2\alpha - \sin 2\alpha} \quad (1)$$

For the range of 0 to 90 of α , $X_L(\alpha)$ start vary from actual reactance X_L to infinity. This controlled reactor is connected across the series capacitor, so that the variable capacitive reactance (figure 3) is possible across the TCSC to modify the transmission line impedance. Effective TCSC reactance X_{TCSC} with respect to alpha (α) is, [6, 7, 8, 9]

$$X_{TCSC}(\alpha) = -X_C + C_1(2(\pi - \alpha) + \sin(2(\pi - \alpha))) - C_2 \cos^2(\pi - \alpha)(\bar{w} \tan(\bar{w}(\pi - \alpha)) - \tan(\pi - \alpha)) \quad (2)$$

where,

$$X_{LC} = \frac{X_C X_L}{X_C - X_L} \quad (3)$$

$$C_1 = \frac{X_C + X_L}{\pi} \quad (4)$$

$$C_2 = 4 \frac{X_{LC}^2}{X_L \pi} \quad (5)$$

$$\bar{w} = \sqrt{\frac{X_C}{X_L}} \quad (6)$$

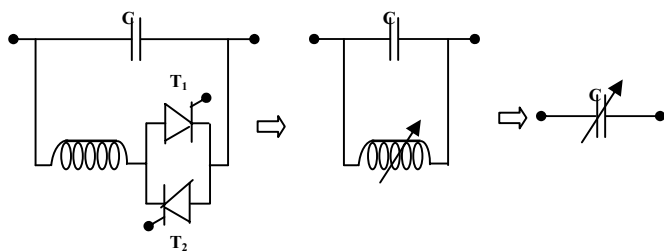

Fig. 3 Equivalent circuit of TCSC

III. IMPEDANCE CHARACTERISTIC

Figure 4 shows the impedance characteristics curve of a TCSC device. It is drawn between effective reactance of TCSC and firing angle α [1, 6, 9, 10]

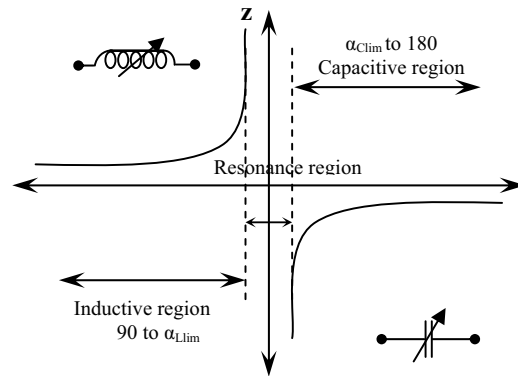

Fig. 4 Impedance Vs firing angle characteristic curve

Net reactance of TCR, $X_L(\alpha)$ is varied from its minimum value X_L to maximum value infinity. Likewise effective reactance of TCSC starts increasing from TCR X_L value to till occurrence of parallel resonance condition $X_L(\alpha) = X_C$, theoretically X_{TCSC} is infinity. This region is inductive region. Further increasing of $X_L(\alpha)$ gives capacitive region, Starts decreasing from infinity point to minimum value of capacitive reactance X_C .

Thus, impedance characteristics of TCSC shows, both capacitive and inductive region are possible though varying firing angle (α).

From $90 \leq \alpha \leq \alpha_{Llim}$ Inductive region.
 $\alpha_{Llim} \leq \alpha \leq \alpha_{Clim}$ Capacitive region
 Between $\alpha_{Llim} \leq \alpha \leq \alpha_{Clim}$ Resonance region

While selecting inductance, X_L should be sufficiently smaller than that of the capacitor X_C . since to get both effective inductive and capacitive reactance across the device.

Suppose if X_C is smaller than the X_L , then only capacitive region is possible in impedance characteristics. In any shunt network, the effective value of reactance follows the lesser reactance present in the branch. So only one capacitive reactance region will appears.

Also X_L should not be equal to X_C value; or else a resonance develops that result in infinite impedance – an unacceptable condition.

Note that while varying $X_L(\alpha)$, a condition should not allow to occur $X_L(\alpha) = X_C$.

IV. RELATION BETWEEN THE TCSC RESONANT POINT AND X_C & X_L : [6]

From equation 2, it shows the relation between w and $X_{Tesc}(\alpha)$. The effective reactance $X_{Tesc}(\alpha)$ would be infinity, when,

$$\bar{w}(\pi - \alpha) = (2m \pm 1) \frac{\pi}{2}; \quad (m = 1, 2, 3, \dots) \quad (7)$$

Or

$$\alpha_{crt} = \pi - \frac{(2m \pm 1)\pi}{2} \quad (8)$$

It is clear from equation (7), that TCSC may appear multiple resonant points in 90° to 180° of firing angle (α). Note in some paper they refer 0° to 90° of β i.e., conduction angle (β).

$$\beta = \alpha - \frac{\pi}{2} \quad (9)$$

However, only one resonant point, namely one capacitive range and one inductive range, is allowable. Multiple resonant points will reduce the operating range of the TCSC. Thus, some measure as to be taken to ensure only one resonant point between 90° to 180° of α . One obvious way to confine the value of factor 'w' by

$$\bar{w} = \sqrt{\frac{X_C}{X_L}} < 3 \quad (10)$$

V. SIMULATIONS ON M - FILE FOR SINGLE RESONANT POINT IMPEDANCE CHARACTERISTIC CURVE. [6, 7]

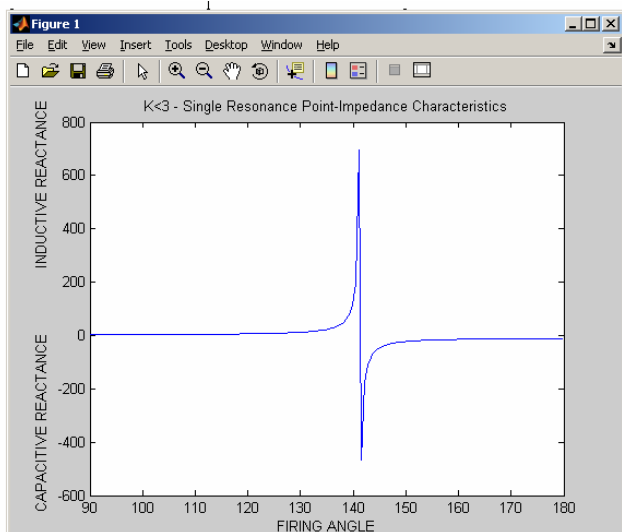

Fig. 4a C = 247.5 μ F, L = 7.6mH

For a practical TCSC, the compensation capacitance depends on the requirement of power system in which the TCSC is installed. Once the capacitance of compensation capacitor is specified, the main factor influencing resonant point of TCSC is the reactance X_L . To verify the above theoretical analysis, the simulation has been carried out for C is 247.5 μ F and for different value of inductances. For L =7.6mH and 8.5mH, w is 2.3209 and 2.1946 which is less than 3 is shown in figure 4a and 4b. It shows the single resonant point.

Figure 4c and 4d showing multiple resonant points, for L is 2mH and 1mH, w is 4.0466 and 6.3983 which violates the equation 10.

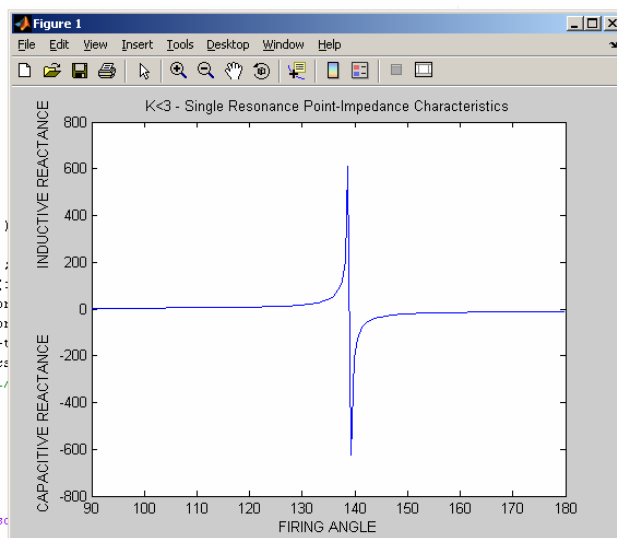

Fig. 4b C = 247.5 μ F, L = 8.5mH

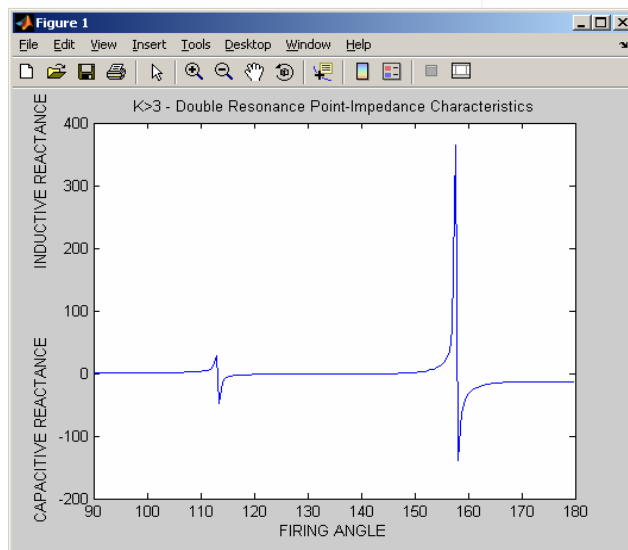

Fig. 4c C = 247.5 μ F, L = 2.5mH

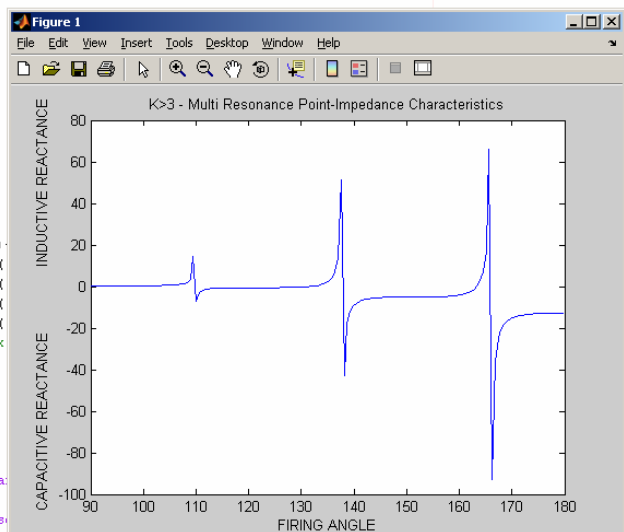

Fig. 4d C = 247.5 μ F, L = 1mH

VI. ANALYSIS OF THE THYRISTOR CURRENT, CAPACITOR CURRENT AND CAPACITOR VOLTAGE

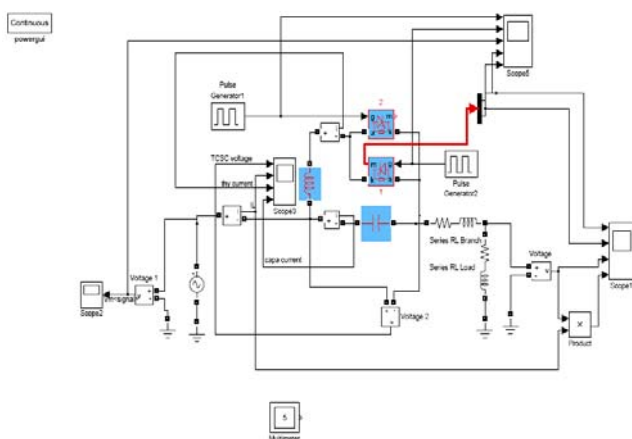

Fig. 5 Simulink model of TCSC device

Figure 5 shows the Simulink model of open loop TCSC device connected in series with the single source transmission line system. For analyzing the Thyristor Current, Capacitor Current and Capacitor Voltage, firing angle pulse are given through pulse generator. To analysis about capacitive mode of TCSC apply the pulse in the region of vernier capacitive region (~ 160 to 180°). This gives the analysis of waveforms of capacitor voltage, line current, thyristor current and capacitor current of TCSC as shown in figure 6.[6, 8, 9, 10]

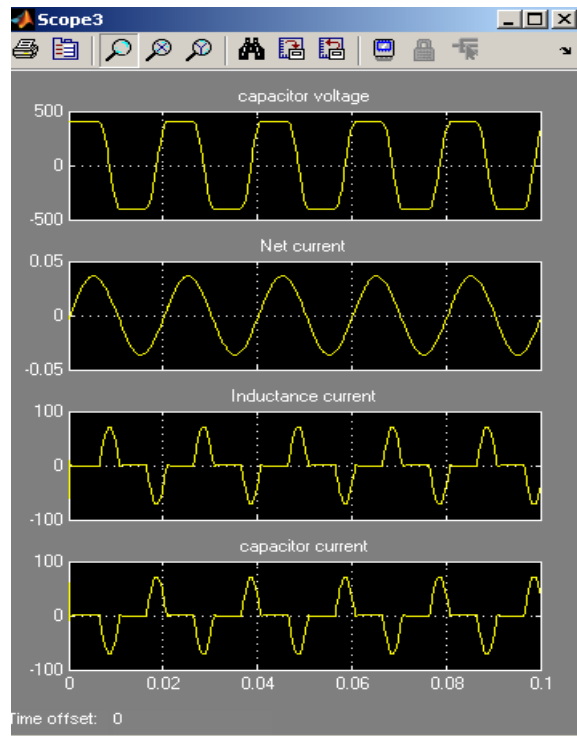

Fig. 6 Alpha is 117° for positive and 297° for negative waveforms

VII. BENEFITS OF TCSC DEVICE IN TRANSMISSION LINE

The development and applications of TCSC device adds advantage of not only increasing the transmission line capacity, also improves the power oscillation damping (POD), sub synchronous resonance (SSR) mitigation and transient stability. Research works are mainly focused on improving SSR mitigation, power oscillation damping, and transient stability, which in turn increases the reliability of the system.

A. Damping of power oscillations using TCSC [6,1]

Events in the transmission system like line switching, line faults etc. disturb the steady condition of electric power and angle δ of the generators in the system. During the fault, the sending end generators tend to speed up (accelerate) and angle δ advance while the receiving end generators slow down (decelerate) and angle δ retard. When the fault is cleared, the generators must find a new equilibrium state, where all run with the same speed and with phase angles δ that comply with the new steady state power flow pattern. Due to the inertia of the generators (and participating machines in the load) and the angle versus power characteristics this new equilibrium point will be reached via an oscillation known as "electromechanical power oscillation" or simply "power oscillation". This may lead to system collapse or result in out of synchronism, loss of interconnections and ultimately the inability to supply electric power to the customer. Series compensation is an effective method to damp out the power oscillation.

Essentially the fixed series capacitor does not provide any substantial damping of the subsequent power oscillation, but a controlled series capacitor (TCSC) affords an artificial damping of the power oscillations. During acceleration of generators and angle δ increases ($d\delta/dt > 0$), the electric power transmitted must be increased to compensate for the excess mechanical input power. On the contrary, when the generators decelerate and angle δ decreases ($d\delta/dt < 0$), the electric power transmitted must be decreased to balance for the insufficient mechanical input power.

Waveform (figure 7) shows the required variation of the degree of series compensation (k), along with undamped and damped oscillation of the angle δ around the steady state value δ_0 and undamped and damped oscillation of the electric power P around the steady state value P_0 . From the study, degree of compensation (k) is maximum, when $d\delta/dt > 0$, and it is zero when $d\delta/dt < 0$ (if k is maximum, then effective line impedance is minimum, and the electric power transferred is maximum. It is converse, when k is zero). Hence by injecting controlled series reactance in the line, achieving an improved damping of power oscillations.

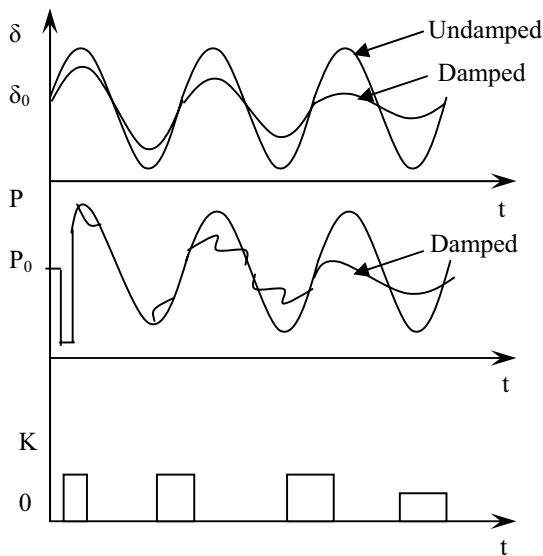

Fig. 7 POD waveforms by controllable series compensation: a) angle, b) electric power and c) degree of series compensation (k)

B. Sub Synchronous Resonance (SSR) [28,1]

Series capacitive compensation is a very economical technique to increase the power transfer capability of long transmission lines. However, this technique may inadvertently increase the risk of subsynchronous resonance (SSR) problems. A series SSR problem was occurred only in the year 1970s, after two turbine-generator shaft failures occurred at the Mojave generating station in southern Nevada. SSR problems result from the interaction between an electrical mode of the series compensated network and a mechanical shaft mode of a turbine-generator group, causing the torsional

oscillations to increase in amplitude until shaft damage occurs if no protective action is taken. The phenomenon of SSR can be briefly described as follows.

Series capacitive line compensation can cause subsynchronous resonance when the series capacitor resonates with the total circuit inductance of the transmission line at a subsynchronous frequency f_e , (subharmonic frequency)

$$f_e = 1/2\pi\sqrt{LC} = f\sqrt{X_C/X_L} \quad (11)$$

If the electrical circuit is brought into oscillation by some disturbance, then the subharmonic component of the line current results in a corresponding subharmonic field in the machine which, as it rotates backwards relative to the main field produced an alternating torque on the rotor at the different frequency of $f-f_e$. If this difference frequency coincides with one of the torsional resonances of the turbine-generator set, mechanical torsional oscillation is excited, which, in turn, further excites the electrical resonance. This condition is defined as subsynchronous resonance (SSR).

In 1981 N.G. Hingorani proposed a thyristor controlled damping scheme for series compensators, which has been proven to provide effective SSR mitigation. The basic principle of the NGH damper is to force the voltage of the series capacitor to zero at the end of the each half period if it exceeds the value associated with the fundamental voltage component of the synchronous power frequency.

C. Transient Stability [3, 1]

The relay in the system detects the fault in the transmission system and cause circuit breaker to open at both ends of the line. When the fault is cleared, the circuit breakers are set to reclose automatically after a preset interval of time thus restoring normal operating status of the original circuit. This sequence of breaking/making events constitutes a shock to the power system and is accompanied by transients.

During the period of transient, system may get unstable and loss its reliability. Thus to improve the transient stability margin, the period of persistence of transients has to be minimized. The system locks back into the steady state once the transient dies out.

Discussion of transient stability improvement can be conveniently evaluated by the equal area criterion. The meaning of equal area criterion is explained by two line system and power P versus angle δ curve, shown in figure 8.

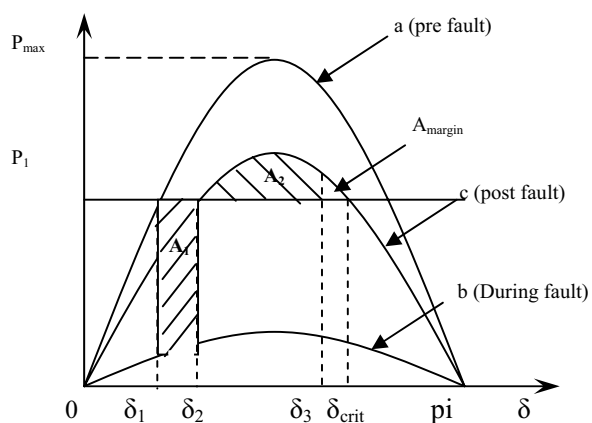

Fig. 8 power Vs angle curve without compensation

Curve 'a', 'b' and 'c' shows the pre fault, during fault and post fault condition of P Vs δ curve. A_1 and A_2 are accelerating and decelerating energy area. The area " A_{margin} " between δ_3 and δ_{crit} gives the transient stability margin of the system. The margin of the transient stability is normally very small under without compensation system. It is possible to improve by either adding a shunt or series type of compensators on the transmission line.

Figure 9 shows the P Vs δ curve of transmission line with series compensators and explains the substantial increase in the transient stability margin area $A_{smargin}$. Increase in transient stability margin is proportional to the degree of series compensation k .

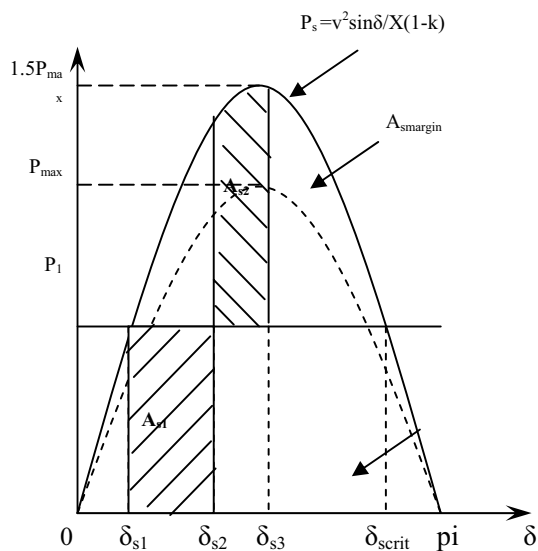

Fig. 9 Power Vs Angle curve with series compensation

VIII. CONCLUSION

The main purpose of this paper is to lay a strong foundation on TCSC. From that point, this paper precisely explained about the operation, characteristic curve and resonance condition of TCSC. This paper inspects the single and multi resonance condition for different value of inductance by MATLAB simulation. In accordance with resonance behavior, used to select an appropriate value of inductance and

capacitance. Simulink modeled TCSC device was presented and relevant waveforms are analyzed in detail. Also this paper studied some additional benefits of TCSC device such as improving power oscillation damping, SSR mitigation and transient stability while connecting on the power system.

REFERENCES

- [1] N. G. Hingorani and L. Gyugyi, *Understanding FACTS Concepts and Technology of Flexible AC Transmission Systems*, IEEE Press,
- [2] R. M. Mathur and R.K. Varma, *Thyristor based FACTS controllers for Electrical transmission systems*, John Wiley & Sons Inc.,
- [3] Arthur R. Bergen Vijay Vittal, "Power System Analysis", Second Edition, Pearson Education Asia, pp 528-529.
- [4] Lennart Angquist, Gunnar Ingstrom, Hans-Ake Jonsson, "DYNAMICAL PERFORMANCE OF TCSC SCHEMES", CIGRE-2006 14:302, ABB power system.
- [5] Naresh Acharya, "Facts and Figures about FACTS", Training Workshop on FACTS Application AIT,EPSPM, Energy, EPSPM, Asian Institute of Technology, December 16, 2004.
- [6] Guowen H U, Ming CHENG, and Guilong CAI, "Relation between Fundamental Frequency Equivalent Impedance and Resonant Point for Thyristor Controlled Series Compensation", 30th Annual Conference IEEE Industrial Electronics Society, vol. 2, pp. 1128-1132, 2004.
- [7] C. R. Fuerte-Esquivel, E. Acha, and H. Ambriz-PBrez, "A Thyristor Controlled Series Compensator Model for the Power Flow Solution of Practical Power Networks", IEEE Transactions on Power Systems. vol. 15, no. 1, pp. 58- 64, February 2000.
- [8] Geng juncheng, Tong luyuan, and Wang Zhonghong, and Ge Jun, "Mathematical Model for describing characteristics of TCSC", IEEE 2002 PP- 14981-502
- [9] L. F. W. de Souza, E. H. Watanabe, J. E. R. Alves, and L. A. S. Piloto, "Thyristor and Gate Controlled Series Capacitors Comparison of Components Rating", IEEE, 2003, pp: 2542-2547.
- [10] M. N. Moschakis, E. A. Leonidaki, N. D. Hatzigaryiou, "Considerations for the Application of Thyristor Controlled Series Capacitors to Radial Power Distribution Circuits", Paper accepted for presentation at 2003 IEEE, PowerTech Conference, June 23-26, Bologna, Italy.
- [11] Kandula Subramaniam, "Demand for power, energy use to double in four years", Indian express, April 30, 2007

S. Meikandasivam was received the Bachelor Degree in Electrical and Electronics Engineering in 2002 and Master Degree in Power Systems in 2005. He also worked as a Lecturer in EEE dept. of Sri Chandrasekharendra Saraswati Viswa Mahavidyalaya (Deemed University), Kanchipuram. Now he currently is pursuing the PhD Degree at Maulana Azad National Institute of Technology (MANIT), Bhopal, India.

Rajesh Kumar Nema was received his PhD degree in Electrical Engineering from Barkatullah University, Bhopal, India in 2004. He is currently AP at the Depart. of Electrical Engg., MANIT, Bhopal, India. His current research interest include power conditioning unit for Renewable Energy storage system particularly Solar Energy, Hybrid Energy Systems, Grid Interconnection of Renewable Energy sources.

Shailendra Kumar Jain received his B.E.(Elect.), M.E.(Power Elex), Ph.D. degree in 1990, 1994 and 2003 respectively and his PDF at UWO London, ON, Canada at 2007. He is currently working as Assistant Professor at the Department of Electrical Engineering, NIT, Bhopal, India. He has been awarded "Career Award for Young Teachers" by AICTE New Delhi, India for the year 2003-2004. His research interests include power electronics and electric drives, power quality improvement, active power filters, high-power factor converters and fuel cell based distributed generation.