

Targeting the Pulmonary Delivery via Optimizing Physicochemical Characteristics of Instilled Liquid and Exploring Distribution of Produced Liquids by Bench-Top Models and Scintigraphy of Rabbits' Lungs

Mohammad Nasri, and Hossein Mirshekarpour

Abstract—We aimed to investigate how can target and optimize pulmonary delivery distribution by changing physicochemical characteristics of instilled liquid. Therefore, we created a new liquids group:

- a. eligible for desired distribution within lung because of assorted physicochemical characteristics
- b. capable of being augmented with a broad range of chemicals inertly
- c. no interference on respiratory function
- d. compatible with airway surface liquid

We developed forty types of new liquid, were composed of Carboxymethylcellulose sodium, Glycerin and different types of Polysorbates. Viscosity was measured using a Programmable Rheometer and surface tension by KRUSS Tensiometer. We subsequently examined the liquids and delivery protocols by simple and branched glass capillary tube models of airways. Eventually, we explored pulmonary distribution of liquids being augmented with technetium-99m in mechanically ventilated rabbits. We used a single head large field of view gamma camera. Kinematic viscosity between 0.265 Stokes and 0.289 Stokes, density between 1g/cm^3 and 1.5g/cm^3 and surface tension between 25dyn/cm and 35dyn/cm were the most acceptable.

Keywords—Pulmonary delivery, Liquid instillation into airway, Physicochemical characteristics, Optimal distribution.

I. INTRODUCTION

MANY attempts and advancements have been made in the recent years in utilizing the lungs, being a robust and desirable organ, as the main entrance of biological agents to the body. Direct instillation of liquid into the pulmonary airways has been employed for many years on account of different application, including surfactant replacement therapy (SRT), liquid Ventilation (LV) (partial and total), gene therapy using vector delivery, diagnostic and therapeutic bronchial alveolar lavage and also in drug delivery [1], [2], [3], [4], [5], [6],... Various studies have, until now, examined the

prescription of chemicals through intra tracheal (IT) instillation [2], [6], [7], [8], [9], [10], and so on.

The problem arising in the application of lost of customary techniques and mediums for liquid administration to the lungs is that the final pulmonary distribution is patchy and partial evenly spread [4], [5], [11], [12], [13], [14], [15]. [1], [16], [7]. In previous experiments, some efforts have been accomplished to distribute liquid optimally to the lungs [1], [4], [5], [11], [17], [12], [13], [18], [19], [20], [21], [9]. They applied different carriers, instillation techniques and ventilation strategies. Throughout these studies it was found out, whenever liquid drains away by a plug (meniscus) occluding the airways, there is more well- spread distribution of the liquid in the distal of plug formation place compared to the drainage being only guided by gravity [4], [1], [20], [22]. Accomplishing the last studies, some important interfering parameters to control the liquid distribution were considered fixed only due to physiological construction of lower respiratory airways or substantial physicochemical characteristics of instilled liquid [17], then these parameters have been explored only a bit.

Every appropriate liquid can be used as liquid carrier [14]. In pulmonary lavage normal saline is prevalently utilized since it is relatively harmless to alveolar surface [14], but the distribution of intra tracheal instilled saline is restricted, to a great extent, to central pulmonary regions [10]. Pulmonary surfactant is preferred to saline because of more well-spread distribution [11], [1], and making use of it as a carrier is under investigation [10], [21], [23]. But its regular usage causes problems including the possibility of interference with biological agents [11]. Breathable liquids are another group of carriers including saline, silicone, vegetable oils and perfluorochemicals, among which perfluorocarbons (PFC) are the most preferable. But they are poor solvents and essentially insoluble. Also, their long-term remaining and higher density are reasons for their cautionary intake [12], [16], [2].

There have been limited experimental studies of liquid physicochemical properties influences on the behavior of instilled medium into the lung [24], [21], [25]. As a result of previous studies, viscosity and density are two determining factors [8], [15] [11]; surface tension is a crucial characteristic

Mohammad Nasri (corresponding author) is with Kerman University of Medical Sciences, Kerman, Iran (e-mail: mnasri.bme@gmail.com).

Hossein MirshekarPour is with Nuclear Medicine Department of Shafah hospital, Kerman University of Medical Sciences, Kerman, Iran (e-mail: Mirshekarpour@yahoo.com).

of instilled liquid, should be considered too. In a study conducted by Cassidy et al, surface tension of surfanta (Ross Labs, Columbus, OH) was reported 25 dyn/cm and 48 dyn/cm at different temperatures, and kinematic viscosity 45 cStokes, also for Peflubron (Alliance Pharmaceutical Corp., San Diego, CA), density=1.93 g/cm³, kinematic viscosity=1.1 cStokes and surface tension=18 dyn/cm [26]. Meanwhile, there are some other influencing factors of less importance. Another important problem in the applicability of this method, being concluded from previous studies [17], is impossibility of plug formation in the adult pulmonary airways because of massive increase in diameters. Motivation of this research is intervention in operative physical and chemical characteristics of instilled liquid aim to influence its guiding and targeting in the lungs. At the same time, another important issue is following the behavior of liquids with these intervened properties after instillation into the lung. Also, we intended to investigate the conditions, under which it's possible to form the meniscus in adults.

II. MATERIALS AND METHODS

Taking aim at intervening in physicochemical characteristics of instilled liquid, we had to formulate and produce some types of liquid with different properties, were worthy of targeting delivery of various chemical types to the lung.

A. Materials

Owing to creating new liquids, three fundamental modules were paid attention principally; Firstly, these liquids must be capable of augmenting with vast types of biological agents including simple structure chemicals such as aminoglycosides to large molecular weight macromolecules like Insulin, and also these medium-biological agent compounds are effective, safe and well-tolerated. Additionally, these new liquids need to be biocompatible, extremely non toxic, highly inert biologically, with no functional reduction of biological agents, no side effects, and no precipitation. Secondary, considering mutual effects between airway surface liquid and instilled liquid, these liquids should be compatible with physical and chemical properties of each other, with no harmful adverse effect. Lastly, using the physicochemical characteristics of these liquid types, they have to be eligible for desired guiding and distribution within the lung with no interference on respiratory function of pulmonary airways.

We focused mainly on viscosity (kinematic viscosity), density, surface tension, interfacial activity and water, alcohols and lipid solubility of the produced liquids, and synchronously contemplated these properties, structure, morphology and ingredients of airway surface liquid.

Airway Surface Liquid, In recent years, modeling of respiratory liquids is a matter of great importance especially in production and development of respiratory drugs [27], [22], [28], [29], [30], [31], [32], [15], [33], [34]. Some typical fluid properties of the mucus [35]:

Viscosity (μ) \approx 1-5 cP are the best ranges for mucus [27]

Density (ρ) \approx 1-1.5 gr/cm³

Surface tension (Ts) \approx 10-200 dyn/cm

Air-water interface in lung varies from high surface pressure \sim 72 mN/m to low surface tension $<$ 5 dyn/cm [36], [37], [38]. Initial surface tension in air-aqueous interface from buffered saline is 67 mN/m [37]. Surfactant lining lower respiratory airways decreases surface tension to 25-35 dyn/cm [17], [39], [32], [34], [35], [40], [41], but without surface-active molecules (surfactants) is estimated to be approximately 45-60 dyn/cm, which is the normal values for biopolymers like proteins, surface polymers of blood cells and polysaccharides [30].

Liquids Preparation, Attributable to developing these new liquids and considering the three fundamental modules, as essential ingredients we selected 1.Carboxymethylcellulose sodium (CMC) as a suspending and viscosity-increasing agent and also water-like polar moiety 2.Glycerin as a solvent, humectant, vehicle and additionally hydrophobic oil-like moiety 3.Different kinds of Polysorbates as surfactant agents and surface active molecules 4.Water as solvent [42] [43] [44].

Amounts of viscosity (kinematic viscosity), density and surface tension were optimized in three steps: a. primarily, taking into consideration approximately fixed amounts of density and surface tension; we picked out different values of viscosity. As a direct result, we could assess effects of various amounts of viscosity and particularly kinematic viscosity on plug formation and optimal delivery. We generated kinds of liquid in instrumental analysis, precision tools and precision measuring equipment labs, and measured viscosity using a Programmable Rheometer (Brook field, DV. III, ULTRA, Engineering laboratories, INC. Middleboro USA). Succeeding that, we selected three of these liquids (Table I), and test them rheologically by bench-top glass capillary tube models.

After obtaining the most advantageous values of viscosity based on rheological behavior of liquids in bench-top experiments and also the best composition of liquid to achieve these amounts; in the next step, much of the work was centered upon surface tension of liquid. Therefore we prepared another twenty-six types of new liquids using different kinds and amounts of polysorbates to lower values of surface tension to the normal range of ASL. We measured surface tension utilizing KRUSS Tensiometer (model k 100 c, Germany). However, concurrent with optimizing the surface tension values, the viscosity quantities raised unsuitably. In final step, because of optimizing measures of all the parameters, we formulated and composed ten other kinds of liquid by making up different amounts of the last-mentioned components and several types of polysorbates. Afterwards, we conducted final rheological experiments on them to choose desirable formulae suitable for different conditions.

B. Bench-top Experiments

There is a body of research on the distribution of instilled liquids into the pulmonary airways such as the liquid distribution in SRT [21], [18], [19], [12], [5], [3], [17], [1],.... In this method liquid administered through a catheter inserted in the endotracheal tube (Fig. 1).

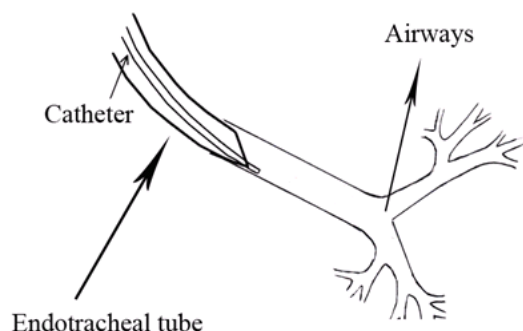

Fig. 1 Schematic of the airways and endotracheal tube with a catheter slipped through it and placed near the airway wall, mimics the clinical practice involving SRT

The modeling assumptions and limitations, Initially, simple models of airways or endotracheal tubes and catheter combination were employed. Since airway geometry changes in different ages, simple glass capillary tubes with diameters of 0.58cm, 0.77cm and 0.85, simulated tracheae of human children of the age ranges 0–2, 2–4 and 4–6 sequentially (each gender) with no disease or condition affecting the airway [46], [47, 48], were used. The elliptical cross-section was assumed in the shape of circular due to simplicity of modeling and computational study, and diameter of the circular cross-section was computed using transverse & anteroposterior diameters of an ellipse equal in area. Also, simple glass cylindrical tubes 0.6cm, 0.7cm, 0.8cm and 0.9cm in diameters were utilized as endotracheal tubes used for human children of the age ranges of 6–8, 8–10 and 10–12 and adults (female and male) serially[49]; just on account of making possible to form the meniscus by way of instilling the liquid into the endotracheal tubes in significant increase in the tracheal diameter of adults and older children. In clinical experiences, at the time of considering endotracheal tube for plug formation location, the catheter tip has to be lifted up into the endotracheal tube. The length of the simple capillary tubes was considered 40 cm, attributable to inhibition of deterrent end effects on plug formation. Provided that demanded circumstances for plug formation make available, the plug will be formed in the leaving area of liquid through the catheter tip; or liquid exits as a stream from the catheter tip, drains down side of the tube and plugs up in a lower place (Fig. 2). Additionally, a bifurcated glass cylindrical tube model with the tracheal dimensions of 5.4 ± 0.7 cm in length, 0.53 ± 0.10 cm in anteroposterior and 0.64 ± 0.12 cm in transverse diameters and tracheal bifurcation angle 71 degree [46], [47]; which simulated tracheae, right and left main bronchi and an airway bifurcation of human children of the age range of 0–2 (no gender difference) with no disease or condition affecting the airway, was used. Three blunt tip catheters with almost flexible firmness in a manner of imitating tube shape without looping, in diameters of 0.07cm, 0.09 cm and 0.14 cm, and connected to a 10 ml syringe were chosen. Glass capillary models were fixed to a specific metal platform.

Experimental method, Before initiating the experiments and after each run, the system was cleaned by deionized water, because it was established that surface impurities can alter the liquid surface tension, and cause liquid and surfactant

adhesion to the surface [50]. After cleaning, distilled water was flushed through the system to wash remains of liquid cleaner. As a result of this; an extreme tiny liquid layer, which simulated the normal conditions in the airways, was remained on the wall of tube; and this wetting interface is necessary for plug formation by the instilled liquid.

A set of experiments was accomplished for every kind of liquids, in which each of the involved agents was considered serially variable. These agents included different instillation methods and delivery techniques, simple and bifurcated glass cylindrical tubes with varying role and pitch angles with respect to horizontal plane and catheters with different dimensions and applied positions.

Before each run, catheter was filled up with liquid on account of making no mistake in calculations of instillation rate, and then that liquid was manually instilled into capillary tube by syringe and with specified volume and instillation rate. In every experiment, a type of catheter suitable for fluent flow of the selected type of liquid and instillation speed and technique considered for that type needed to be selected. Experiment was repeated with each kind of liquids with different instillation speeds. Necessary volume of instilled liquid bolus was calculated in accord with minimum essential volume due to plug formation $\sim 1.6D^3$ and in the manner that it was enough to assess the liquid bolus behavior, also with due attention to possibility for infusing demanded volume of viscous liquids in least ratable time. On account of plug formation, different catheter of desirable diameter among three types and different positions including catheter positioned at the wall or located away from the wall and also its locations along the length of capillary tubes were employed; moreover, varying role and pitch angles of branched and pitch angle of simple cylindrical tubes regarding horizontal plane to form meniscus in demanded location of simple tubes with specific diameters or each branch of bifurcated tube were used. Afterwards, the plug splitting in an airway bifurcation model and also liquid and plug behavior during inspiration were investigated. Lastly, the findings of bench-top experiments were generalized to large airways pathways. Every experiment was timed and recorded to digital videotape with respect to formation or no formation of plug in the demanded location, and also time and position of meniscus formation in the capillary tube.

C. Animal Model Experiments

Animal preparation, These experimental protocols were reviewed and approved by the University Committee on Use and Care of Animals. Primarily 5 New Zealand white rabbits of either sex, weighing ~ 3 kg, were dissected and studied in view of practical anatomy, in which tracheobronchial and pulmonary system of rabbit were explored macroscopically, also diameters and angles were measured employing calipers and advanced set square with the aim of achieving nearly average of airway diameters. These dimensions did not vary significantly with the results of previous study achieved by Loewen et al. [51]. Following, experimental strategy on other rabbits of the same species of either sex, weighing ~ 3.0 kg was set up. Initially 5 mg/kg xylazine and 20 mg/kg ketamine were administered intramuscularly to provide anesthesia. Succeeding that, an intravenous catheter was placed in the ear

and heparin (100 units/kg) was administered [52] [21], [25]. Tracheotomy was performed and the trachea was cannulated with an uncuffed 3 mm inner diameter endotracheal tube (ETT) and tightly secured in place by peritracheal ligature to prevent leakage and regurgitation of instilled liquid. Pancuronium (0.1 mg/kg) was administered intravenously. The rabbits were then mechanically ventilated with a tidal volume of 8 ml/kg, a frequency of 40/min, an inspiratory to expiratory ratio of 1:1 and a PEEP level of 5 cmH₂O. Mechanical ventilation was provided by a small animal ventilator (Harvard Apparatus, Holliston, MA).

Experimental protocol, Final liquid type 3, being selected following bench-top experiments regarding suitable rheological properties, was marked by incorporation of technetium-99m. Tc 99m was utilized second to fifth elutes with 24 hours elution interval. For each case, 10 mCi isotonic solution of Na^{99m}TcO₄ was utilized. Aim to study the distribution pathway and among the real time imaging techniques, we used a single head large field of view gamma camera (Phillips, gamma DIAGNOST TOMO) equipped to low energy all purpose parallel hole collimator set up on 20% energy window around 140 keV and Matrix of 256 * 256 pixels were used.

After initial ventilation; each of rabbits, being remained in supine position, was placed and fixed in one demanded neck and chest positions. Neck position with respect to horizontal plane settles the tracheal position and the role and pitch angles, especially in carina bifurcation. Despite various airways orientations, clinically the infant and adult patients can be postural positioned purposefully in a manner that the majority of airways of each lung or specific lobe were situated in the direction of gravitational force [49]. Liquid was instilled through catheter, slipped through the endotracheal tube, into the lungs. Introducing the liquid was carry out by four quarter-dose aliquots of 1 ml/kg, and the rabbit was hand ventilated for 30 s between each aliquot at a rate of 40 breaths/min and with a tidal volume almost 8 ml/kg. After accomplishing the instillation, the rabbit was returned to the ventilator. During the setup experiment, some animals died because of respiratory insufficiency following reflux of more viscous liquid types after instillation. To remedy this problem, the liquid types with lower viscosity such as final type 3, and also higher tidal volumes or other mechanical volume recruitment maneuvers were used. One minute following liquid instillation, image acquisition was started from rabbit head-to-thigh in field of view with 1 frame/minute up to one hour. Zoomed views up to 2 times were also obtained during the study. Targeted distribution of radiolabeled liquid throughout demanded location comprising right or left lung or every lobos of them was evaluated by special software and expressed as a percentage of difference between hottest and coldest pixel in each location. After completion of this procedure at 60 minutes, the rabbit was euthanized with an overdose of pentobarbital, subsequently, rabbit's chest wall was dissected, and then tracheo-pulmonary system was exposed and totally excised from the body, and overly counted by gamma camera within one minute. Succeeding that the lungs were filled with cold saline until fully distended, and the pulmonary lavage saline was obtained again totally by syringe. This procedure was repeated five times, and the regained volumes were

pooled. The pooled liquid was used to measure technetium-99m radioactivity. The obtained results from the lungs after lavage employing gamma camera indicated the aforesaid outcomes.

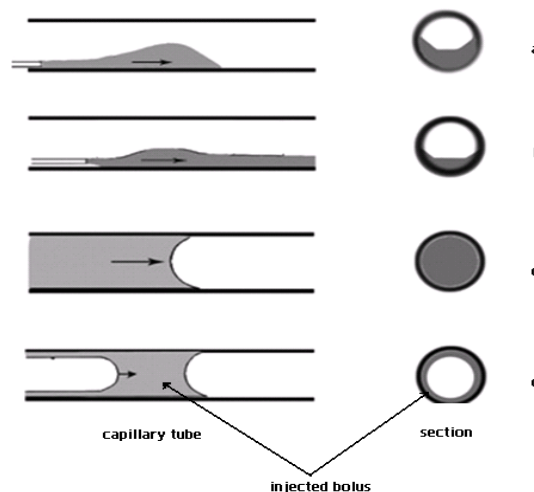

Fig. 2 Schematics of an instilled liquid bolus propagating in a capillary tube. (a) Bolus of liquid initially instilled into the capillary tube (b) Running at a loss of requiring conditions to form the plug, liquid drains down the side of tube as a stream (c) Under demanding circumstances the plug forms (d) Deposited film lining the tube left behind on the tube wall by direct coating following meniscus passage

D. Analysis and Formulation

Behavior, transport, pathway and final distribution of the instilled liquids were determined by a set of fundamental rules of fluid dynamics and mechanics, rheological and flow properties of non-Newtonian and viscous liquids, physicochemical and rheological properties of the bodily liquid, biochemical sciences and surface engineering. To study how physical and chemical characteristics of liquid influences transport and distribution, how the instilled liquid can be guided and directed at lower respiratory airways by altering these properties, and also understanding the physical mechanisms for liquid delivery to the lung; theoretical models of an instilled liquid bolus in a single straight tube and a bifurcation tube model were considered.

Halpern et al. studied plug formation and transport regimes in the airways by means of surfactant bolus behavior, and set forth four distinct transport regimes for it, namely, liquid plug, deposited film lining the airways, surface layer and alveolar compartment; each one is controlled by different physical forces [2], [37].

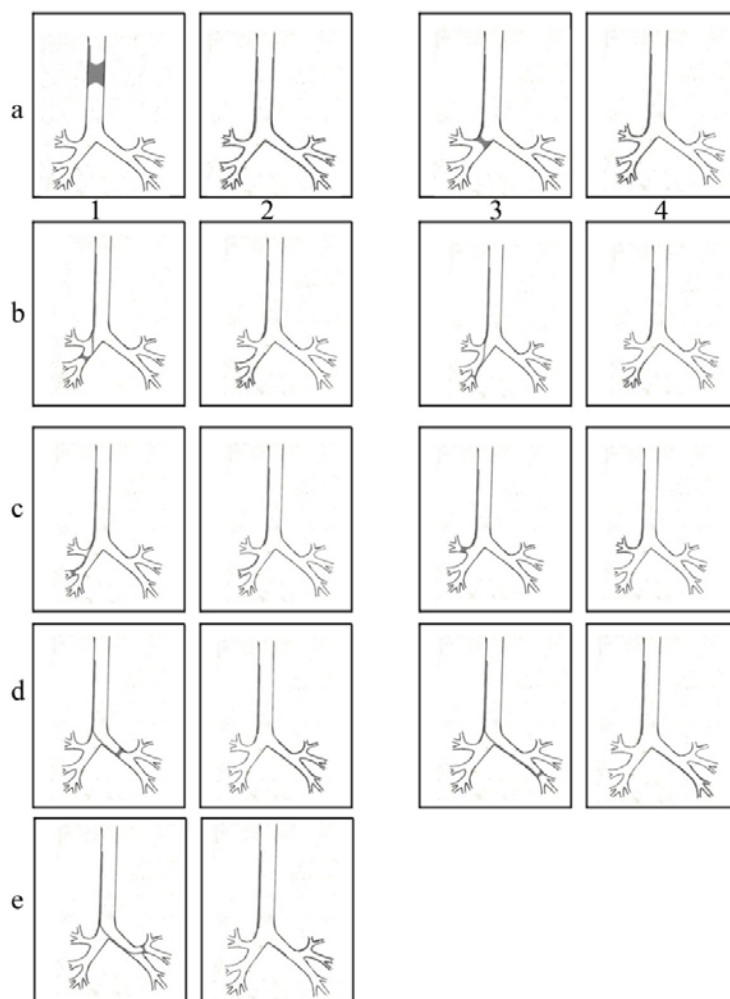

Fig. 3 Simplified schematic diagrams of distributions of liquid after instillation using various delivery methods into the pulmonary airways. At any time the plug forms, there is evenly distribution of the liquid in the distal of plug formation place. Then in order for evenly distribution of liquid in any lobe or region of the lung, liquid plug must be formed in its main airway or else entered into it, even in the upper lobes and airways and in the direction against the gravity and upwards. Also plug forms in the gravity dependent drainage. In all these schematic diagrams, the liquid drains by the film layer deposited either subsequent to plug rupture, or by direct coating following bolus passage

Meniscus (plug) takes formation as a result of conditions under which the liquid would not be able to drain away from instillation site with a speed equal to that of instillation. When the depth of accumulated liquid reaches the critical depth, the surface tensions forces operate. Finally subsequent to overcoming these forces, liquid surrounds the perimeter, and occludes the tube; thereafter the plug will be formed. But plug can be formed provided the volume of accumulated liquid in the vicinity of catheter tip is enough [18]. Fig. 2 shows schematics of instilled liquid bolus into the cylindrical tube, maybe plug forms, perhaps not. Whenever the plug forms, there is a section surrounded by liquid. The degree of liquid local accumulation is determined by the interference of momentum (inertia) of the liquid exited from the catheter tip and gravity; which both cause the liquid to move forward into pulmonary airways; and also by viscous shear stress, which

prevents the liquid from moving forward in the airways [18], [53], as shown in Fig. 4.

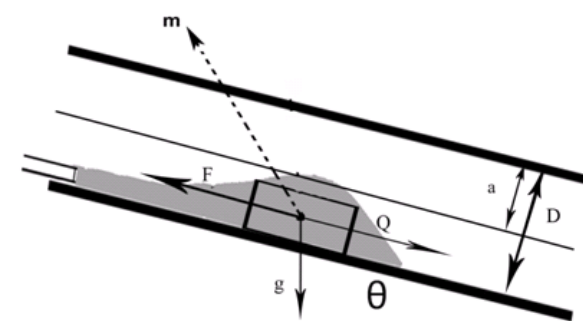

Fig. 4 Instilled liquid bolus in a cylindrical tube positioned at θ angle with respect to horizontal plane. The local accumulated liquid come under the influences of momentum, which studied by considering density (ρ) and instillation speed (Q), gravity (g) and viscous forces (F); D , cylindrical tube diameter; a , tube radius; m , liquid bolus mass

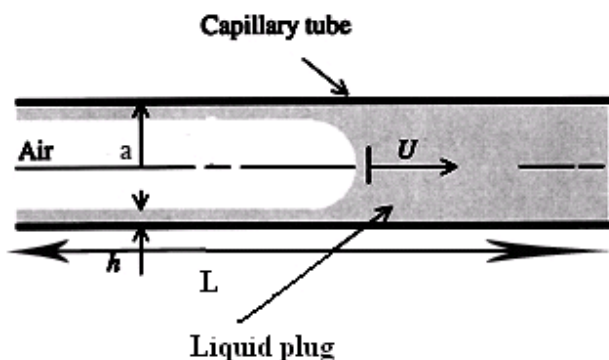

Fig. 5 Capillary model for a propagating liquid plug. Meniscus moves forward from left to right with a velocity of U , and leaves behind a film lining layer in the thickness of h . a , capillary tube radius; L , tube length

$$Q_{crit} \geq \frac{2.53 \times 10^{-4}}{d} \left(\frac{\rho}{\mu}\right)^2 (g \sin \theta)^{3/2} D^{13/2} \quad (1)$$

(Fig. 4), where Q_{crit} is the minimum instillation speed required to from the plug and the maximum speed to prevent temporary occlusion, ρ is the density and μ is the viscosity of the liquid, D is the diameter of the airway (endotracheal tube) or capillary tube, d is the diameter of the catheter and θ is the pitch angle.

The thickness of deposited film lining airways can be expressed as a function of Capillary number,

$$Ca = \mu \frac{U}{\sigma} \quad (2)$$

(Fig. 5), where U is measure of the velocity within the liquid pool and σ is the surface tension of liquid.

The liquid film drainage is affected by gravitational force and surface tension gradient. Overcoming the surface tension requires the film layer to grow thin enough, so that this force ignites the distribution [2].

$$\text{Bond number, } Bo = \frac{\rho g a^2}{\sigma} \quad (3)$$

, quantifies the ratio of gravitational forces to surface tension forces, where a is capillary tube radius and g is acceleration due to gravity.

Tube resistance against fluid flow (R) is determined by

$$\text{Poiseuille's law} \rightarrow R = \frac{8\mu L}{\pi a^4} \quad (4)$$

, where L is capillary tube length.

III. RESULTS

Table I shows the physicochemical characteristics of three initial types of produced liquids selected in the first stage and also ten final types, including surface tension (TS), viscosity (Vis) and density (Den). The values of surface tension, viscosity and density are presented sequentially on the basis of dyn/cm, Poise and gr/cm^3 .

TABLE I
 PHYSICAL CHARACTERISTICS OF THREE INITIAL SELECTED AND TEN FINAL TYPES OF LIQUIDS

	TS	Vis	Den
I	58.32	0.175	1.09
II	60.00	0.284	1.07
III	63.00	0.681	1.06
1	30.48	0.601	1.140
2	30.92	0.405	1.400
3	33.40	0.370	1.300
4	29.87	0.420	1.230
5	29.25	0.530	1.200
6	28.60	0.620	1.059
7	29.25	0.600	1.100
8	28.60	0.650	1.050
9	28.98	0.650	1.088
10	28.81	0.549	1.116

Surface tension (TS), viscosity and density were presented on the basis of dyn/cm, Poise and gr/cm^3 serially

Table II shows the surface tension of three initial selected liquids, the 26 produced types in the stage of adjusting and optimizing surface tension values and 10 final types.

TABLE II
 SURFACE TENSION AND PRESSURE OF ALL SELECTED TYPES OF LIQUIDS

	1	2	3	4	5	6	7	8	9	10
TS	58	60	63	37	36	34	31	30	32	30
	11	12	13	14	15	16	17	18	19	20
TS	32	30	34	40	35	37	40	36	36	34
	21	22	23	24	25	26	27	28	29	30
TS	33	33	35	36	35	33	32	35	31	30
	31	32	33	34	35	36	37	38	39	
TS	31	33	30	29	29	30	29	29	29	

Fig. 6 shows some acquired images of rabbits' lungs scintigraphy. In whole body scan image, Tc 99m was clearly observed in the rabbits' kidneys at round about 1.5 minutes after instillation, also the other parts show targeting the labeled liquid to various regions of rabbits' lungs.

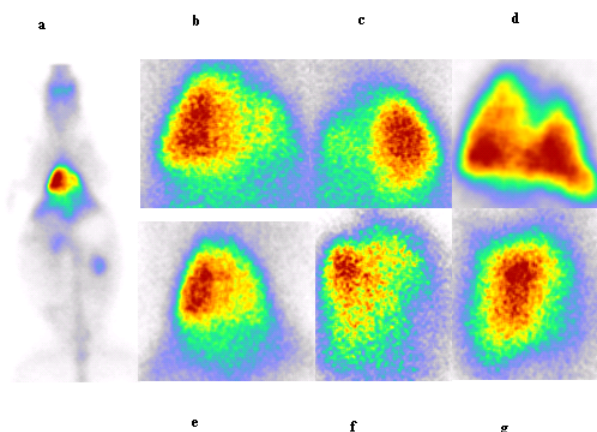

Fig. 6 Some produced two-dimensional images of rabbits' lung scintigraphy by scintillation camera. (a) Whole body scan (b) Targeting to the right lung (c) Targeting to the left lung (d) Homogeneous distribution of liquid in both lungs (e) Guiding towards right upper lobe (f) Saline filled lungs (g) lungs after lavage

IV. DISCUSSION

From the bench-top and animal experiments also further theoretical analysis, it was concluded that the behavior of liquid in the trachea and pulmonary airways is directly influenced by viscosity and more specifically kinematic viscosity, density, surface tension and interfacial activity. The optimal distribution and targeting to the demanded location of lungs and airways pathways and even guiding against the direction of gravity is possible only whether the plug can be formed by instilled liquid, and also this plug formation must be in the main airway of an intended region, or else entered into it; then the liquid can be evenly distributed throughout the airways pathway located after meniscus formation place by the film layer. In Fig. 3 some schematic diagrams of plug formation in different airways and subsequent distribution of

the liquid are displayed. It was found out [1], the Plug formation is even evident in the gravity dependent drainage (Fig. 3).

As the first step, aim at production of the liquid types, the initial and essential components were chosen in a way that no adverse biological, morphological or histological effects were observed in any of them and also in the result of their interference. The utilized substances as essential ingredients: 1. **carboxymethylcellulose sodium**; the sodium salt of polycarboxymethyl ether of cellulose, used as a suspending agent, excipient (inert substance) and viscosity-increasing agent, 2. glycerin, used as solvent, humectant, and vehicle in

TABLE III
 Q_{CRIT} AMOUNTS

Q _{crit} Liquid	D 0.58	D 0.77	D 0.85	D 0.6	D 0.7	D 0.8	D 0.9	D 0.56	D 0.37	d 0.07	d 0.09	θ 10°	θ 30°	θ 40°
I	12.49	78.81	149.84	15.57	42.42	101.04	217.26	9.95	0.67	24.99	19.43	4.52	22.08	32.18
II	4.57	28.84	54.83	5.70	15.52	36.97	79.50	3.64	0.25	9.14	7.11	1.65	8.08	11.78
III	0.78	4.92	9.36	0.97	2.65	6.31	13.57	0.62	0.04	1.56	1.21	0.28	1.38	2.01
1	1.16	7.31	13.90	1.44	3.93	9.37	20.15	0.92	0.06	2.32	1.80	0.42	2.05	2.98
2	3.85	24.28	46.15	4.80	13.07	31.12	66.92	3.06	0.20	7.70	5.99	1.39	6.80	9.91
3	3.98	25.08	47.68	4.96	13.50	32.15	69.13	3.16	0.21	7.95	6.18	1.44	7.03	10.24
4	2.76	17.42	33.13	3.44	9.38	22.34	48.03	2.20	0.15	5.52	4.30	1	4.88	7.11
5	1.65	10.41	19.80	2.06	5.61	13.35	28.71	1.314	0.09	3.30	2.57	0.60	2.92	4.25
6	0.94	5.93	11.27	1.17	3.19	7.60	16.34	0.75	0.05	1.88	1.46	0.34	1.66	2.42
7	1.08	6.83	12.98	1.35	3.67	8.75	18.82	0.86	0.06	2.16	1.68	0.39	1.91	2.79
8	0.84	5.30	10.08	1.05	2.85	6.80	14.61	0.67	0.05	1.68	1.31	0.30	1.49	2.16
9	0.90	5.69	10.82	1.12	3.06	7.30	15.69	0.72	0.05	1.80	1.40	0.33	1.59	2.32
10	1.33	8.39	15.96	1.66	4.52	10.76	23.14	1.059	0.07	2.66	2.07	0.48	2.35	3.43

Q_{crit} amounts for different types of liquid were calculated on account of various influential agents including diameters of cylindrical tubes (D) of 0.58cm, 0.77cm, 0.85cm, 0.6cm, 0.7cm, 0.8cm and 0.9 cm, also diameters of rabbit's airways (D) involving trachea and main bronchus sequentially 0.56cm and 0.37 cm and catheter diameters (d) of 0.07cm, 0.09 cm and inclination angles 10°, 30° and 40° with respect to horizontal plane. For primary conditions (column 1 to 9), d and θ were considered 0.14 and 20° serially. Q_{crit} was presented on the basis of cm³/s

various pharmaceutical preparations, and also 3. polysorbates group, employed as surfactant agents, are three inert substance groups with no specific harmful property in pharmaceutical preparation [43], [44], [45].

Evidently, viscosity is a crucial factor in the efficiency of drug delivery and targeting [7], therefore, the liquids (primary and final liquid types) were produced with different amounts in a wide range of viscosity (Fig. 7) by varying proportion of ingredients. Considering the plug formation, instillation speed of liquid (Q) plays an important role, and there is significant Q_{crit} for each specific type of liquid relating to every interfering variable (1) (Table III). Among all the produced liquids, there was no possibility of forming the meniscus by only the primary liquid type I in all bench-top experimental studies, with the exception of 0.58 cm inner diameter capillary tube positioned at a slighter angle than 10° with respect to horizontal plane employed 0.14 cm catheter; also the obtained Q_{crit} values for this type referring to different variables (Table III) were not applicable except for slighter pitch angles. It was meaningful from the direct observation of liquid transition

behavior in bench-top tubes and previous studies [25], [3], the lower the viscosity, the less the possibility of plug formation in the instillation site; and as a result the liquid bolus is guided to the smaller airways under the influence of gravity or forced air, and may be plug is formed there because reducing the airway diameter results in much easier plug formation (1). As shown in Table III, Q_{crit} values decreased dramatically while liquid bolus entering main bronchi of rabbit lung compared to Q_{crit} in trachea. At any time gravity related targeting is demanded, lower viscosity liquids can be chosen.

Also aim to guide the liquid bolus towards main or lobar bronchi, liquid types with lower viscosity or instillation speed lower than Q_{crit} in the trachea (Table III) or even a slight increase in the inclination angle of trachea with respect to horizontal plane can be used, then it makes physically impossible to form the plug in the instillation site, and the liquid bolus flows down into the lower pathways; and therefore the bolus can be guided towards demanded airways pathway by postural positioning. Also aim to this, specific

airway intubation techniques for main or lobar bronchi, or bronchoscopy can be utilized. Following guiding the liquid into demanded location of airways pathways, plug can be formed there because of decrease in airway diameter, and consequently, liquid distribute in a very even pattern throughout the purposed lung or lung's lobe which ventilated by those airways. Accordingly, the meniscus could be formed from final liquid type 3 in each type of simple capillary tubes, even in the capillary tube with diameter of 0.9 cm (maximum selected diameter) by decreasing the pitch angle for example from 20°, being used typically, to 10° (Table III). Also, the meniscus formation place could be changed in each simple capillary tube by varying instillation speed (Q) or inclination angle (θ) or catheter type (d). In branched cylindrical tube model, the plug could be formed and guided purposefully into the branches by altering physical variables such as role and pitch angles, Q or catheter diameter. Accomplishing animal model experiments, liquid type 3 could be delivered to each rabbit's lung or lung's lobe by changing all the physical variables (Fig. 6). Theoretically, the plug can be formed in rabbit trachea by this type, also, it's possible to guide the liquid to bronchus by varying the angles, Q or catheter diameter and plug will be formed there. Performing animal experiments, the aforementioned results were obtained as well. Also, the mechanical recruitments were used on account of inhibition of reflux and choking. There are bilateral restrictions on marked increase or decrease in viscosity regarding compatibility with ASL, proper airways function, guiding capability of instilled liquid and reflux occurrence. It was confirmed [54], [32] that significant increase in the viscosity of secretions causes impairment in their ciliary clearance, and originating all the airway inflammatory diseases; also, will directly result in the reduction of chemical absorption level in the lung and significant increase in its time [9], [25, 7]. Also, viscosity of ASL plays a key role in the entrapment and keeping the particles [31], then it can be theoretically lowered only to a threshold of ~ 1-5 cP [28].

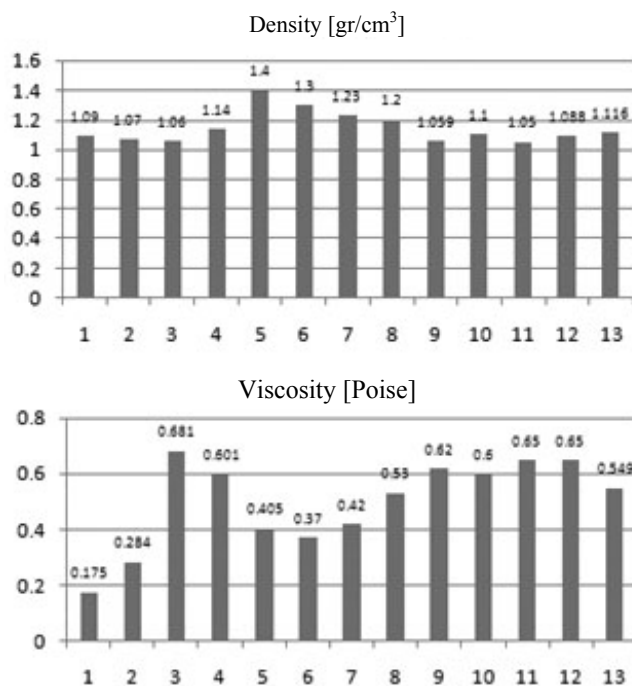
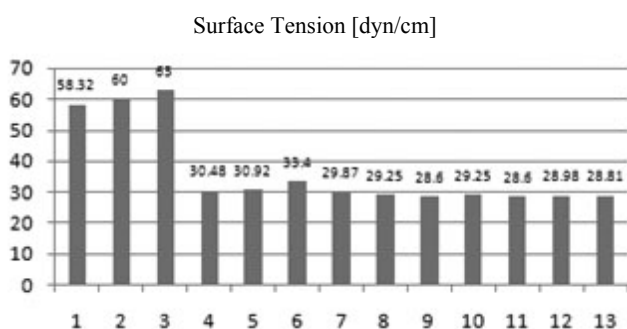

Fig. 7 The Bar charts illustrate different amounts of physicochemical characteristics of primary and final produced liquids

When the plug is formed, depending on the position of formation and its time in the respiratory cycle, may be guided out of the trachea during exhalation [2], also, the possibility of reflux of more viscous liquids will increase at higher instillation speeds [21]. Because of faster instillation, the liquid drains away from the instillation site much slower than introducing speed; then it result in liquid stasis and accumulation in the location. Also, as shown in the Poiseuille's law, liquid flow resistance in the tube is in direct relation to the viscosity; and it was shown [15] that it is more related to kinematic viscosity (ν) compared to absolute viscosity (μ). While increase in viscosity or instillation speed passes the threshold, it leads to liquid reflux or probably choking [2], [19] [15], [4], [8], [19], [22]. Tube resistance against most of the produced liquids showed dramatic high level, especially in primary liquid type III and final liquid types 1, 5, 6, 7, 8, 9 and 10, and consequently, advancing meniscus velocity (U) of these types reduced dramatically in bench-top experiments. Performing animal experiments, during set up stage some instances of reflux or choking after instillation of these types occurred.

After bench-top and animal experiments it was significant; concerning the viscosity, liquid type II among the three selected liquids in the first stage and two types 2 and 3 among the ten types produced in the last stage are the most suitable ones due to the optimal spreading capability. In spite of their slight high viscosity, these two liquid types seem to be suitable for guiding through airways because of the fitting kinematic viscosity; also the Q_{crit} amounts obtained from Q_{crit} equation (1) for these types in different situations (Table 3) are approximately the most suitable among all types. And in bench-top experiments, they flew down fluidly in the capillary tubes.

During the second phase, with the aim of optimizing the surface tension values several formulas were compounded. Finally, the amount of surface tension was lowered for the price of increasing dramatically the viscosity quantity. These elevated values of viscosity caused extraordinary rising in the tube resistance and severe liquid flow stasis. Then because of this increased resistance and very prolonged movement of these liquid types in the capillary tubes, it's probably impossible to use them in the clinic. Survanta viscosity is 1.0 Poise in 25°C and 0.75 Poise in 37°C [3]. So as a carrier in this method of drug delivery, its viscosity does not look appropriate for the desirable guiding.

After instillation of liquid bolus, the thickness of liquid lining layer all along the airways tree is in direct relation to capillary number (Ca). Considering Ca, it is concluded that more viscosity or higher advancing meniscus velocity (resulting from higher instillation speed or airflow shear effects) makes the greater part of the liquid bolus cover the airways walls rather than go to the alveoli; afterwards the thicker layer was left behind [3], [4, 23], [25]. As a result, with higher values of Ca, liquid bolus will be torn in a way more proximal, thereafter the thicker lining layer will cover the tube wall. This liquid lining layer can be guided to the intended route or location of airways tree by plug formation; and consequently, the more desirable and equal distribution of liquid will be achieved.

At the time of instillation of liquid bolus, the surface tension forces are almost ineffective in liquid transference due to the volume and thickness of liquid layer and diameter of airway. Also, assessment of Bond number (3) indicates that unlike surface tension, gravity has little influence in small airways, but increased Bo in large airways show that the transverse gravity may prevent airway from occlusion [35]. Inertial effect is also to be considered in large airways. In a study, Bretherton described that effects of inertia can be ignored providing $Re * Ca \ll 1$ (Reynolds number, $Re = \frac{\rho Q D}{\mu d^2}$, where Q is the instillation speed), and also gravity whenever $Bo \ll 1$. Everywhere the thickness of liquid layer is to an extent which can be impressed by surface tension gradient, this force makes the liquid drain away from the location (i.e. its increase will decrease Ca directly). Thus everywhere the surface tension influences drainage; it will reduce the liquid layer thickness directly. Whenever there is enough amount of the liquid; surface tension determines the possibility of meniscus formation [6]. But it is concluded from the previous studies that the degree of surface tension does not affect the plug formation of the instilled liquid, because its least amounts are always available [18].

$$\text{Laplace's law} \longrightarrow \text{pressure (dyn/cm}^2\text{)} = \frac{2 * \text{surface tension (} \frac{\text{dyn}}{\text{cm}} \text{)}}{\text{radius (cm)}} \quad (5)$$

This equation determines that due to the very small radius of environmental airways, liquids with high surface tension like water or saline need high pressures to pass through these airways [11]. Surface tension in the thin liquid covering layer is the first mechanical reason responsible for the occlusion in the environmental regions of the human lung [35], [29].

Instability and growth rate in the liquid layer thickness is augmented as surface tension and the initial film thickness increases, and diminished as viscosity increases [35], [36] [55], [35]. Produced liquids physicochemical properties seem strikingly similar to non-Newtonian liquid group; also these liquids are viscous liquids group. The aforementioned properties probably bring about more instability in ASL, in the same way as Halpern et al. [6] specified a viscoelastic liquid layer can be more unstable compared to a newtonian liquid layer. Performing set up stage of animal experiments, there was a case of airway occlusion and choking following instillation of primary liquid type II in the apparent lack of liquid reflux. Afterwards, from the evidences we could infer that it happened because of dramatic increased level of surface tension of this type. The lower the surface tension of surface active film in the conducting airways, the more the particles floatation in the aqueous sub phase [41]. Also the surface tension staircase in the environmental airways can lead to alveolar clearance improvement, because surface tension gradient can result in upward movement of the water [40], [42].

It is clarified that the surface tension acts as a double-edged blade in the lung; in this way that its marked increase or decrease rather the range of natural degrees will be problematic. Therefore it can be changed so cautiously and considering the normal amounts of the surface tension in the air-liquid interface of healthy lung. To decrease the surface tension, the surface activity can be augmented utilizing the surface active materials. Surfactants are one recognized surface active group in pharmaceutical science such as the pulmonary surfactants and the natural surfactants. There are convincing evidences to suggest that the presence of a surface active layer such as pulmonary surfactant in the airways is responsible for maintaining airways patency [56], [57], [38], [9], [31], [35], [55] [2].

Surface active substances possess valuable and applicable characteristics to instilling into ASL and mucus [54], [32], [58], [9], [55], [11], [29], [59], [60]. Taking aim at these properties, the function of tween 80 (one more suitable type of polysorbates family) is very desirable [54]. Although the tendency of our liquids for instability was increased because of the non-Newtonian and viscous properties, the presence of polysorbates in their composition caused the instability reduction, and also decreased the incidence of airway occlusion.

Polysorbates family is one highly characteristics group of surface active agents with the valuable features of surface activity. In creating the preliminary types of liquids, it was aimed at optimizing the values of viscosity; but those compositions resulted in elevating inappropriately amount of the surface tension to unnatural extent (Table I). Thus, after the viscosity, our efforts were concentrated on decreasing the surface tension values to the natural amounts of ASL of conducting airways. Then, in addition to the composition of CMC and glycerin, the variable types and amounts of polysorbates were utilized to lower the surface tension values. Taking aim at this, 26 other types of liquids were produced after long and extremely difficult experiments to optimize the surface tension value (Table II). But these altered compositions caused rising in the value of viscosity by great

amount, and higher reduction in the amount of surface tension will cause massive increase in the viscosity in the same way. Thus, decreasing the amount of surface tension might be coming to an end. The least amount of surface tension, 28.60 dyn/cm², was obtained in liquid types 35 and 37 (Table II). Taking into account the normal range, the obtained surface tension amounts around 30 dyn/cm² were supposed suitable for instilling into the conducting airways. Then in the final stage; at the attempt the values of viscosity, density and surface tension were optimized synchronously by including all the modules and intended characteristics and after producing additional 10 types of liquids (Table I). These final products were developed through composition of different amounts of all the initial building blocks including glycerin, CMC, and different types of Polysorbets.

The density was adjusted in a way that firstly be very close to its natural degree in the liquids or soft tissue of the body (density of water is 1 gr/cm³ and blood, 1.06 gr/cm³); since higher density compared to bodily liquids leads to guiding the blood flow [8]. The densities of 3 produced liquids in the first stage were almost the same as bodily liquids; and among the final liquids group, the densities of types 2 and 3 were the most values. Although these last types can re-expand the atelectatic regions, their higher values of density will likely influence guiding the liquids through the airways.

The basic elements used in the production of these liquids are in a way that CMC was used as hydrophilic polar moiety, glycerin as hydrophobic oil-like moiety, and polysorbates as surfactant agents [43], [61], [44]. Consequently it is possible to add a vast range of biological agents with lyophilic or lipophilic attributes to this solution due to the extended chemical bounds.

We also conducted a scientific study into the different methods of mechanical and lung ventilation effects on optimal distribution of liquids. Carrying out scintigraphy and regarding bioavailability, the marked liquid was clearly observed in the rabbits' kidneys at round about 1.5 minutes after instillation. All accomplished stages of this study mentioned in the present text will be described separately in detail in the forthcoming manuscripts. The adding capability of different groups of biological agents to these liquids is still under investigation, and they were augmented with different types of chemicals. Also these new liquids are being studied regarding pharminochemistry, pharmacokinetics and pharmacologic effects and also from histological aspect in lungs' tissues and epithelium. However in order to use these produced liquids as a new group of carriers for pulmonary chemical delivery and instillation into the lung, further investigations are required.

ACKNOWLEDGMENT

The corresponding author thanks Dr. Shahrokh S. Gudarzi, Shahid Beheshti University of Medical Sciences, Tehran, Iran, and Dr. Majid Shakiba, Imam Hospital of Tehran, Iran, for helpful comments in writing the preliminary draft of this manuscript, Dr. Alireza Mortazavi, Shahid Beheshti University of Medical Sciences, Tehran, Iran, and Dr. Payam Khazaeli, Kerman Medical University, Kerman, Iran, for advantageous comments in formulating carriers, and

acknowledges the Department of Chemistry, Shahid Bahonar University of Kerman, Iran, for building the designed glass capillary tubes and Mohammad Daneshpajoo of Faculty of Pharmacy, Kerman Medical University, Kerman, Iran, for helps with producing formulated carriers and Dr. Ali Amirbeigi, Clinical Skills Center, Bahonar Hospital of Kerman, Iran for useful helps with facilitating the bench-top experiments.

REFERENCES

- [1] K. J. Cassidy, J. L. Bull, M. R. Glucksberg, C. A. Dawson, S. T. Haworth, R. Hirschl, N. Gavriely and J. B. Grotberg, A rat lung model of instilled liquid transport in the pulmonary airways, *Journal of Applied Physiology* 90 (2001), no. 5, 1955-1967.
- [2] D. Halpern, O. E. Jensen and J. B. Grotberg, A theoretical study of surfactant and liquid delivery into the lung, *Journal of Applied Physiology* 85 (1998), no. 1, 333-352.
- [3] F. F. Espinosa and R. D. Kamm, Bolus dispersal through the lungs in surfactant replacement therapy, *Journal of Applied Physiology* 86 (1999), no. 1, 391-410.
- [4] J. C. Anderson, R. C. Molthen, C. A. Dawson, S. T. Haworth, J. L. Bull, M. R. Glucksberg and J. B. Grotberg, Effect of ventilation rate on instilled surfactant distribution in the pulmonary airways of rats, *Journal of Applied Physiology* 97 (2004), no. 1, 45-56.
- [5] C. L. Kerr, Y. Ito, S. E. E. Manwell, R. A. W. Veldhuizen, L. J. Yao, L. A. McCaig and J. F. Lewis, Effects of surfactant distribution and ventilation strategies on efficacy of exogenous surfactant, *Journal of Applied Physiology* 85 (1998), no. 2, 676-684.
- [6] D. Halpern, H. Fujioka, S. Takayama and J. B. Grotberg, Liquid and surfactant delivery into pulmonary airways, *Respiratory Physiology and Neurobiology* (2008).
- [7] Y. L. Zhang, O. K. Matar and R. V. Craster, A theoretical study of chemical delivery within the lung using exogenous surfactant, *Medical Engineering & Physics* 25 (2003), no. 2, 115-132.
- [8] D. J. Smith, L. M. Gambone, T. Tarara, D. R. Meays, L. A. Dellamary, C. M. Woods and J. Weers, Liquid dose pulmonary instillation of gentamicin pulmospheres® formulations: Tissue distribution and pharmacokinetics in rabbits, *Pharmaceutical Research* 18 (2001), no. 11, 1556-1561.
- [9] R. Banerjee, J. R. Bellare and R. R. Puniyani, Effect of phospholipid mixtures and surfactant formulations on rheology of polymeric gels, simulating mucus, at shear rates experienced in the tracheobronchial tree, *Biochemical Engineering Journal* 7 (2001), no. 3, 195-200.
- [10] J. R. Badia, D. Soy, M. Adrover, M. Ferrer, M. Sarasa, A. Alarco, C. Codina and A. Torres, Disposition of instilled versus nebulized tobramycin and imipenem in ventilated intensive care unit (icu) patients, *Journal of Antimicrobial Chemotherapy* 54 (2004), no. 2, 508-514.
- [11] J. J. Haitzma, U. Lachmann and B. Lachmann, Exogenous surfactant as a drug delivery agent, *Advanced Drug Delivery Reviews* 47 (2001), no. 2-3, 197-207.
- [12] M. Ikegami, K. Wada, G. A. Emerson, C. M. Rebello, R. E. Hernandez and A. H. Jobe, Effects of ventilation style on surfactant metabolism and treatment response in preterm lambs, *American Journal of Respiratory and Critical Care Medicine* 157 (1998), no. 2, 638-644.
- [13] M. Krause, T. Olsson, A. B. Law, R. A. Parker, D. P. Lindstrom, H. W. Sundell and R. B. Cotton, Effect of volume recruitment on response to surfactant treatment in rabbits with lung injury, *American Journal of Respiratory and Critical Care Medicine* 156 (1997), no. 3 I, 862-866.
- [14] O. K. Matar, A. H. Jobe and M. Ikegami, Positive end-expiratory pressure preserves surfactant function in preterm lambs, *American Journal of Respiratory and Critical Care Medicine* 160 (1999), no. 2, 634-639.
- [15] C. Sekins; K. Michael (San Diego, Shaffer; Thomas H. (Lansdowne, PA), Wolfson; Marla R. (Wyndmoor, PA) "Apparatus for pulmonary delivery of drugs with simultaneous liquid lavage and ventilation", vol. 5,562,608, BioPulmonics, Inc. (Redmond, WA) Temple University (Philadelphia, PA) USA, October 8, 1996 p. 112 of 134.
- [16] O. K. Matar, R. V. Craster and M. R. E. Warner, Surfactant transport on highly viscous surface films, *Journal of Fluid Mechanics* 466 (2002), 85-111.
- [17] Y. Zheng, H. Fujioka, J. C. Grotberg and J. B. Grotberg, Effects of inertia and gravity on liquid plug splitting at a bifurcation, *Journal of Biomechanical Engineering* 128 (2006), no. 5, 707-716.

- [18] F. F. Espinosa and R. D. Kamm, Meniscus formation during tracheal instillation of surfactant, *Journal of Applied Physiology* 85 (1998), no. 1, 266-272.
- [19] K. Wada, A. H. Jobe and M. Ikegami, Tidal volume effects on surfactant treatment responses with the initiation of ventilation in preterm lambs, *Journal of Applied Physiology* 83 (1997), no. 4, 1054-1061.
- [20] M. F. Krause, C. Jakel, J. Haberstroh, J. Schulte-Monting, J. U. Leittitis and M. Orłowska-Volk, Alveolar recruitment promotes homogeneous surfactant distribution in a piglet model of lung injury, *Pediatric Research* 50 (2001), no. 1 I, 34-43.
- [21] J. L. Bull, S. Tredici, E. Komori, D. O. Brant, J. B. Grotberg and R. B. Hirschl, Distribution dynamics of perfluorocarbon delivery to the lungs: An intact rabbit model, *Journal of Applied Physiology* 96 (2004), no. 5, 1633-1642.
- [22] B. J. Smith and D. P. Gaver, The pulsatile propagation of a finger of air within a fluid-occluded cylindrical tube, *Journal of Fluid Mechanics* 601 (2008), 1-23.
- [23] U. Kaisers and K. P. Kelly, Liquid ventilation, *British Journal of Anaesthesia* 91 (2003), no. 1, 143-151.
- [24] K. J. T. S. Manaker, "Liquid ventilation," *Up To Date* 16.1, P. E. Parsons (Editor), *Up To Date, Inc.*, January 2008.
- [25] S. Tredici, F. Tredici, D. O. Brant, R. B. Hirschl and J. L. Bull, Effect of viscosity on instilled perfluorocarbon distribution in rabbit lungs, *Journal of Biomechanical Engineering* 128 (2006), no. 6, 857-861.
- [26] W. W. Fox, C. A. Cox, C. M. Weis, M. R. Wolfson and T. H. Shaffer, Comparison of perfluorochemical fluids used for liquid ventilation: Effect of endotracheal tube flow resistance, *Pediatric Pulmonology* 23 (1997), no. 6, 449-456.
- [27] K. J. Cassidy, N. Gavriely and J. B. Grotberg, Liquid plug flow in straight and bifurcating tubes, *Journal of Biomechanical Engineering* 123 (2001), no. 6, 580-589.
- [28] M. Vasudevan and C. F. Lange, Surface tension effects on instability in viscoelastic respiratory fluids, *Mathematical Biosciences* 205 (2007), no. 2, 180-194.
- [29] A. L. Hazel and M. Heil, Three-dimensional airway reopening: The steady propagation of a semi-infinite bubble into a buckled elastic tube, *Journal of Fluid Mechanics* (2003), no. 478, 47-70.
- [30] G. M. Roomans, I. Kozlova, H. Nilsson, V. Vanthanoovong, B. Button and R. Tarran, Measurements of airway surface liquid height and mucus transport by fluorescence microscopy, and of ion composition by x-ray microanalysis, *Journal of Cystic Fibrosis* 3 (2004), no. Supplement 2, 135-139.
- [31] S. Schürch, M. Geiser, M. M. Lee and P. Gehr, Particles at the airway interfaces of the lung, *Colloids and Surfaces B: Biointerfaces* 15 (1999), no. 3-4, 339-353.
- [32] J. H. Widdicombe, Regulation of the depth and composition of airway surface liquid, *Journal of Anatomy* 201 (2002), no. 4, 313-318.
- [33] H. Nilsson, I. Kozlova, V. Vanthanoovong and G. M. Roomans, Collection and x-ray microanalysis of airway surface liquid in the mouse using ion exchange beads, *Micron* 35 (2004), no. 8, 701-705.
- [34] A. J. Hirsh, Altering airway surface liquid volume: Inhalation therapy with amiloride and hyperosmotic agents, *Advanced Drug Delivery Reviews* 54 (2002), no. 11, 1445-1462.
- [35] M. Heil, A. L. Hazel and J. A. Smith, The mechanics of airway closure, *Respiratory Physiology & Neurobiology*, in Press, Corrected Proof.
- [36] M. Vasudevan and C. F. Lange, Property dependence of onset of instability in viscoelastic respiratory fluids, *International Journal of Engineering Science* 43 (2005), no. 15-16, 1292-1298.
- [37] J. B. Grotberg, "Respiratory fluid mechanics and transport processes," *Annual Review of Biomedical Engineering*, vol. 3, 2001, pp. 421-457.
- [38] K. Nag, A. Hillier, K. Parsons and M. F. Garcia, Interactions of serum with lung surfactant extract in the bronchiolar and alveolar airway models, *Respiratory Physiology & Neurobiology* 157 (2007), no. 2-3, 411-424.
- [39] S.-H. Yu, P. G. R. Harding and F. Possmayer, Artificial pulmonary surfactant: Potential role for hexagonal hii phase in the formation of a surface-active monolayer, *Biochimica et Biophysica Acta (BBA) - Biomembranes* 776 (1984), no. 1, 37-47.
- [40] H. Bachofen and S. Schürch, Alveolar surface forces and lung architecture, *Comparative Biochemistry and Physiology - Part A: Molecular & Integrative Physiology* 129 (2001), no. 1, 183-193.
- [41] S. Schurch, P. Gehr, V. Im Hof, M. Geiser and F. Green, Surfactant displaces particles toward the epithelium in airways and alveoli, *Respiration Physiology* 80 (1990), no. 1, 17-32.
- [42] D. A. Sabatini, R. C. Knox, J. H. Harwell and B. Wu, Integrated design of surfactant enhanced dnapl remediation: Efficient supersolubilization and gradient systems, *Journal of Contaminant Hydrology* 45 (2000), no. 1-2, 99-121.
- [43] S. C. Sweetman, *Martindale: The complete drug reference*, vol. 1, Pharmaceutical Press, 2007.
- [44] M. Bertram G. Katzung, PhD, *Basic and clinical pharmacology*, Mc Graw Hill, 2007.
- [45] J. P. Remington and A. R. Gennaro, *Remington: The science and practice of pharmacy*, Mack Pub. Co., 1995.
- [46] N. T. Griscom and M. E. B. Wohl, Dimensions of the growing trachea related to age and gender, *American Journal of Roentgenology* 146 (1986), no. 2, 233-237.
- [47] T. E. Keats, *Atlas of roentgenographic measurement*, 1990.
- [48] T. E. Keats and C. Siström, *Atlas of radiologic measurement*, Mosby, 2001.
- [49] A. Michael P. Czervinske; Sherry L. Barnhart, RRT, *Perinatal and pediatric respiratory care*, vol. 1, SAUNDERS, 2003.
- [50] J. L. Bull and J. B. Grotberg, Surfactant spreading on thin viscous films: Film thickness evolution and periodic wall stretch, *Experiments in Fluids* 34 (2003), no. 1, 1-15.
- [51] M. S. Loewen and D. L. Walner, Dimensions of rabbit subglottis and trachea, *Laboratory Animals* 35 (2001), no. 3, 253-256.
- [52] P. Flecknell, *Manual of rabbit medicine and surgery*, Blackwell Sciences, 2000.
- [53] H. D. Yung and R. A. Freedman, *University physics*, Addison Wesley Publishing Co. Inc., 1996.
- [54] S. T. Ballard, J. C. Parker and C. R. Hamm, Restoration of mucociliary transport in the fluid-depleted trachea by surface-active instillates, *American Journal of Respiratory Cell and Molecular Biology* 34 (2006), no. 4, 500-504.
- [55] K. Cassidy, D. Halpern, B. Ressler, P. Howell and J. B. Grotberg, Surfactant effects on the stability of a viscous fluid lining a capillary tube, *FASEB Journal* 11 (1997), no. 3.
- [56] J. Hohlfeld, H. Fabel and H. Hamm, The role of pulmonary surfactant in obstructive airways disease, *European Respiratory Journal* 10 (1997), no. 2, 482-491.
- [57] G. Enhörning, J. Hohlfeld, N. Krug, G. Lema and R. C. Welliver, Surfactant function affected by airway inflammation and cooling: Possible impact on exercise-induced asthma, *European Respiratory Journal* 15 (2000), no. 3, 532-538.
- [58] S. Jayaraman, N. S. Joo, B. Reitz, J. J. Wine and A. S. Verkman, Submucosal gland secretions in airways from cystic fibrosis patients have normal [na+] and ph but elevated viscosity, *Proceedings of the National Academy of Sciences of the United States of America* 98 (2001), no. 14, 8119-8123.
- [59] A. Silberberg, Biorheological matching: Mucociliary interaction and epithelial clearance, *Biorheology* 20 (1983), no. 2, 215-222.
- [60] P. Wollmer, K. Backstrom, H. Zhao, P. G. Nilsson and B. Jonson, Surface active agents as enhancers of alveolar absorption, *Pharmaceutical Research* 17 (2000), no. 1, 38-41.
- [61] J. C. B. James Swarbrick, *Encyclopedia of pharmaceutical technology*, vol. 1, Marcel Dekker, Inc., 2002.