

# The Calculation of Electromagnetic Fields (EMF) in Substations of Shopping Centers

Adnan Muharemovic, Hidajet Salkic, Mario Klaric, Irfan Turkovic, Aida Muharemovic

**Abstract**—In nature, electromagnetic fields always appear like atmosphere static electric field, the earth's static magnetic field and the wide-rang frequency electromagnetic field caused by lightening. However, besides natural electromagnetic fields (EMF), today human beings are mostly exposed to artificial electromagnetic fields due to technology progress and outspread use of electrical devices. To evaluate nuisance of EMF, it is necessary to know field intensity for every frequency which appears and compare it with allowed values. Low frequency EMF-s around transmission and distribution lines are time-varying quasi-static electromagnetic fields which have conservative component of low frequency electrical field caused by charges and eddy component of low frequency magnetic field caused by currents. Displacement current or field delay are negligible, so energy flow in quasi-static EMF involves diffusion, analog like heat transfer. Electrical and magnetic field can be analyzed separately. This paper analysis the numerical calculations in ELF-400 software of EMF in distribution substation in shopping center. Analyzing the results it is possible to specify locations exposed to the fields and give useful suggestion to eliminate electromagnetic effect or reduce it on acceptable level within the non-ionizing radiation norms and norms of protection from EMF.

**Keywords**—Electromagnetic Field, Density of Electromagnetic Flow, Place of Professional Exposure, Place of Increased Sensitivity

## I. INTRODUCTION

**R**EGULATIONS of protection from electromagnetic field appearing nearby transmission and distribution substation, (i.e. regulation of protection from non-ionizing radiation) become valid recently.

Transformer substations and overhead power lines are sources of electromagnetic field with frequency of 50Hz which belongs to extremely low frequency area [1, 2].

The basic limits for some parameters as limits for effects harmful to humans functionally depend on current density, specific absorbed energy and power density.

Reference values are measurable, and by monitoring those basic restrictions can be satisfied. Physical values which can be used as referent values are: electric field intensity, magnetic field intensity, magnetic flux density, touch current and power density [3, 4].

A.M. Author is with the Energoinvest d.d. Sarajevo; (e-mail: adnan.muharemovic@energoinvest.com).

H.S. Author is with Elektroprivreda BIH (e-mail: h.salkic@elektroprivreda.ba).

M.K. Author is with the Dalekovod d.d. Zagreb; (e-mail: mario.klaric@dalekovod.hr).

I.T. Autor is with Electrical Engineering Department, University of Sarajevo, (e-mail: irfan.turkovic@etf.unsa.ba).

A.M. Autor is with BH Telecom, (e-mail: aida.muharemovic@gmail.com).

During the construction and operation of transformer substation and overhead power lines it is necessary to determine if low frequency EMF value is higher than permitted value which is defined by regulation of protection from EMF.

Regulation of protection from EMF [3] - [5] defines two areas that need calculation of EMF values:

- the areas of the professional exposure, where possible exposure to EMF maximum to 8 hours per day, and where slightly higher field values are permitted, and
- the areas of the increased sensitivity, which include:
  - a) residential areas where possible exposure to EMF 24 hours per day
  - b) schools, hospitals, kindergartens, playgrounds, place where vulnerable population groups (children, pregnant, patients) spend time and where all day exposure is possible. These types of areas needs lower limit values.

For analysing electromagnetic fields emission of transformer substation and overhead power lines limits values of fields into standards allowed are important [6] - [8]. Limit values of field for 50Hz frequency are given in table below:

The Area of Protection	Electrical Field Intensity E (kV/m)	Magnetic Field Intensity H (A/m)	Magnetic Flux Density B(μT)
The Area of the Professional Exposure	5	80	100
The Area of the Increased Exposure	2	32	40

The source of EMF which produces field intensity at least 10% of limited value for given frequency, in one of two previously mentioned areas, is considered to be significant source of EMF.

## II. CALCULATION OF EMF USING EFC-400 SOFTWARE

The calculation of EMF for distribution transformer substation 10(20)/0.4 kV were done in EFC-400 software which supports 3D simulation. An assumption is that current sources are line conductors which can be presented as thin wires (cross-section can be ignored). The conductor from which current leaks is presented by straight segments. The calculation of electric and magnetic field at some points in space, which is far from line source, (grounding element – length of grid conductors) can be done by using current and potential distribution [9]. The value of current a uniformly distributed on line conductor segment is determined by voltage

drop between end points as limiting points of that segment. Impedance of line segment is also taken in consideration.

For determination of potential at some point, as the result of linear source segment existence, the method of images is used. The phasor of electric potential at some point in space is obtained by application of superposition theorem as the final sum of potentials caused by elementary and time-varying charges on the surface of the conductor. Total value of potential at some point in space, caused by a uniformly distributed current on segment of thin line conductor, can be calculated according to following equation:

$$\bar{\varphi} = \frac{1}{4\pi\epsilon} \int_{r'} \frac{\bar{\rho}(r')dl'}{|r-r'|} + \frac{1}{4\pi\epsilon} \int_{r''} \frac{\bar{\rho}(r'')dl''}{|r-r''|} \quad (1)$$

Where are:

$\bar{\rho}(r')$  - line charge density of original conductor (A/m)

$\bar{\rho}(r'')$  - line charge density of images conductor (A/m)

$|r-r'|$  - distance between analysed point and line charge density of original conductor (m)

$|r-r''|$  - distance between analysed point and images line charge density of conductor (m).

In order to solve the equation (1) it is necessary to do its discretization. This can be done by discretization of field source of unknown distribution, i.e. density line charge  $\bar{\rho}(r')$  combination of appropriate number N linear independent fundamental function. In that case, discretization of conductor length on N segments and discretization of analyzed point are connected. The conductors are divided on segment with finite length  $\Delta l_j$  ( $j=1, \dots, N$ ). Approximation of unknown field distribution with appropriate number of fundamental function  $\rho_j$  is needed afterwards, in the following form:

$$\bar{\rho}_{r'}(r') = \sum_{j=1}^N a_j' \rho_j' \quad \text{and} \quad \bar{\rho}_{r''}(r'') = \sum_{j=1}^N a_j'' \rho_j'' \quad (2)$$

Where are:

$\rho_j'$  - fundamental function on segment  $j$  of original conductor,

$\rho_j''$  - fundamental function on image segment  $j$  of conductor

Constants  $a_j' = 1$  and  $a_j'' = 1$  were chosen for analyzed segment, while for other segments constants are 0. Because constant of segments was chosen as fundamental function and it requests high precision, number of segments on conductor

was increased so the length of the longest segment is less than 1m long. In that case potential equation has following form:

$$\bar{\varphi}(r) = \frac{1}{4\pi\epsilon} \sum_{j=1}^N \int_{\Delta l_j} \frac{a_j' \rho_j'(r') dl'}{|r-r'|} + \frac{1}{4\pi\epsilon} \sum_{j=1}^N \int_{\Delta l_j} \frac{a_j'' \rho_j''(r'') dl''}{|r-r''|} \quad (3)$$

Because  $\rho' = \rho''$ , equation (3) has N unknowns on the right side of equation. In order to solve equation (3), N analyzed points in space with known potential values were chosen, and those points are matching conductor under voltage. This gives a system with N equations and N unknowns. The system is given in matrix form:

$$[\varphi] = [M] [\rho], \quad (4)$$

where elements  $M_{i,j}$  of matrix system are potentials of analyzed points "i" placed on the surface of conductor with current density  $\rho_j$ . The matrix equation was solved by Gauss-Seidel method. When approximation of current density on conductors is obtained, vector-phasor of conservative component of electric field intensity at observed point, with vector position  $r$ , can be determined using following equation:

$$\bar{E}(r) = \frac{1}{4\pi\epsilon} \sum_{j=1}^N \int_{\Delta l_j} \frac{a_j' \rho_j'(r)(r-r') dl'}{|r-r'|^3} + \frac{1}{4\pi\epsilon} \sum_{\Delta l_j} \frac{a_j'' \rho_j''(r)(r-r'') dl''}{|r-r''|^3} \quad (5)$$

In 3D calculation vector of electric field intensity is elliptical polarized in every point, i.e. top of vector  $E$  in time makes an ellipse in time. Each of three components have different intensity and phase shift:

$$\begin{aligned} E_x(t) &= E_{x \max} \cos(\omega t + \varphi_x) \\ E_y(t) &= E_{y \max} \cos(\omega t + \varphi_y) \\ E_z(t) &= E_{z \max} \cos(\omega t + \varphi_z) \end{aligned} \quad (6)$$

Vector of electric field is elliptical polarized and rotates in time. For presenting electric field, effective values (RMS) of electric field intensity absolute value were used, as it follows:

$$E_{ef} = \sqrt{\frac{1}{T} \int_0^T [E_x^2(t) + E_y^2(t) + E_z^2(t)] dt} \quad (7)$$

Calculation of the magnetic flux density distribution is performed by procedure based on application of Biot-Savart law for the induction of finite-length straight streamline, and superposition rule. Magnetic flux density at each point of space can be calculated by superposing the contributions of each conductor with current flows. Large position of conductor segments, their current and phase angles present input values for calculation of magnetic flux density in desired points of space. Direction of magnetic flux density vector is determined by unit vector in cylindrical coordinate system related to analyzed segment. Positions of segments and directions of induction vectors are different in space, and thus it is necessary to break down a vector of magnetic flux density into components in direction of each coordinate axis of global system that is not related to a particular segment. Direction of magnetic flux density vector is perpendicular to the limit plane and defined as:

$$B = \frac{\mu_0}{4\pi} \int_{l_j} \frac{\bar{I} dl \times (r - r')}{|r - r'|^3} \quad (8)$$

Total intensity of magnetic flux density vector, caused by currents in  $N$  segments, is obtained by adding contributions of each segment:

$$B(t) = \sqrt{\left(\sum_{i=1}^N B_{x,i}(t)\right)^2 + \left(\sum_{i=1}^N B_{y,i}(t)\right)^2 + \left(\sum_{i=1}^N B_{z,i}(t)\right)^2} \quad (9)$$

where  $B_{x,i}(t)$ ,  $B_{y,i}(t)$ ,  $B_{z,i}(t)$  are components of magnetic flux density of  $i$  segment.

For presentation of magnetic field, effective value of magnetic flux density is used, as given in following equation:

$$B_{ef} = \sqrt{\frac{1}{T} \int_0^T [B_x^2(t) + B_y^2(t) + B_z^2(t)] dt} \quad (10)$$

Transformer substation 20(10)/0.4 kV (3x1600 kVA, 4x4600 kVA, 5x1600 kVA) (TS 1, TS 2 and TS 3) in shopping center are connected on middle-voltage network with one-wire cable XHE 49-A. This cable is having nominal cross-section of 3x(1x180) mm<sup>2</sup> with Al conductor, isolation of cross-linked polyethylene and electrical protection of Cu wire and spiral Cu foil. Below and above of the cable screen there is semi-conductive tape which makes possible longitudinal waterproofing of the screen in case of failure on sheet. This 20 kV cable is lead up to the first block transformer, TS 1, than the same type of cable is lead up to block TS 2 and than two cables to block TS 3 as shown on Fig.1. Transformer block TS 1 is first on connection of 20kV cable. On middle-voltage side

there are 2 middle-voltage lines installed and 3 transformer lines. In TS 2 on middle-voltage side there are 2 middle-voltage lines and 5 transformer lines. In TS 3 there are 2 middle-voltage lines and 5 transformer lines with same characteristic. In transformer chamber there are dry epoxy three-phase transformers having power of 1600 kVA, 20/0.4 kV, without cabinet, with a adjusted fan for additional cooling. Middle-voltage blocks are made by 24 kV, 630 A, 16 kArms, SF6 gas isolation, with disconnecting switch in over head power lines and vacuum circuit breaker in transformer lines, difference module according to requirements TS. In TS there are installed dry power transformer, nominal power 1600 kVA, nominal transmission ratio 20000/10000/420/231 V, connection type Dyn5, Uk=6,0% .

Previously described substations along with equipment are modeled in EFC-400 software. The maximum possible current load of transformer VN/SN is considered to be 46.23 A with nominal voltage on secondary transformer of 20kV and  $I_m$  on 0.4 kV side 2320 A. Loading of 46.23 A and 2320 A can appear very rarely, but calculation were done using this values due to safety reasons. This current loading is distributed on few 0.4 kV over head lines, thus a minimum of 20 over head lines. This implies that the maximum total current loading of some over head lines is 2320/20=116 A. Over head lines 0.4 kV are modeled with current loading of 116 A for the worst case.

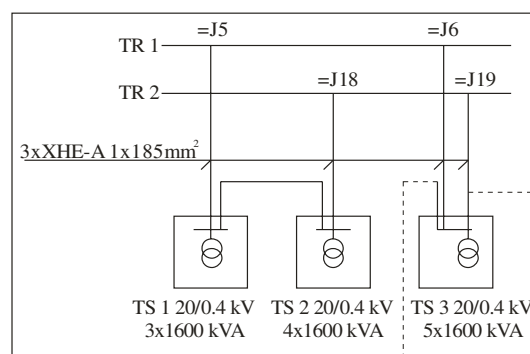

Fig. 1 Block Scheme of Electrical Substation TS 20/0.4 kV (3x1600 kVA, 4x1600 kVA, 5x1600 kVA) TS1, TS2, TS3

The calculation results of electric field intensity and magnetic flux density on height of 1.5 m above the ground level in continuous distribution, for analyzed transformer substations are shown in Fig. 2.2 - 2.16

A. TS 1 20/0.4 kV

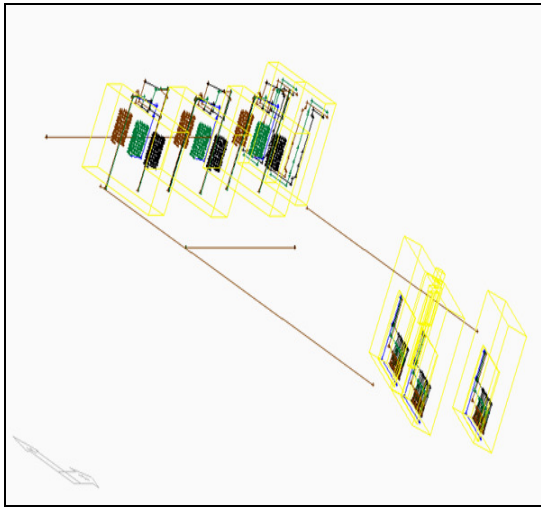

Fig. 2 3D presentation of disposition TS 1 20/0.4 kV in EFC-400 software

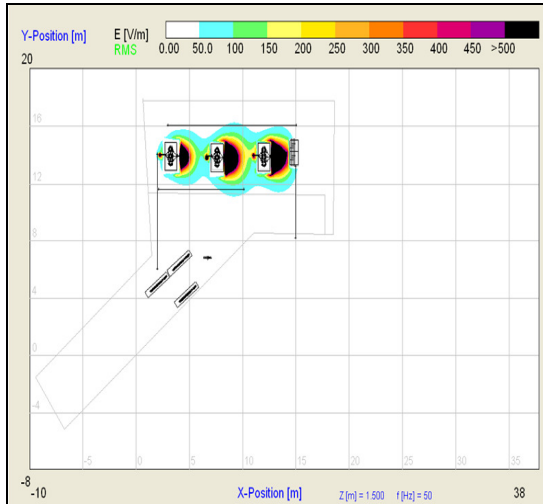

Fig. 3 Distribution of electrical field intensity TS 1 20/0.4 kV– 2D continual distribution

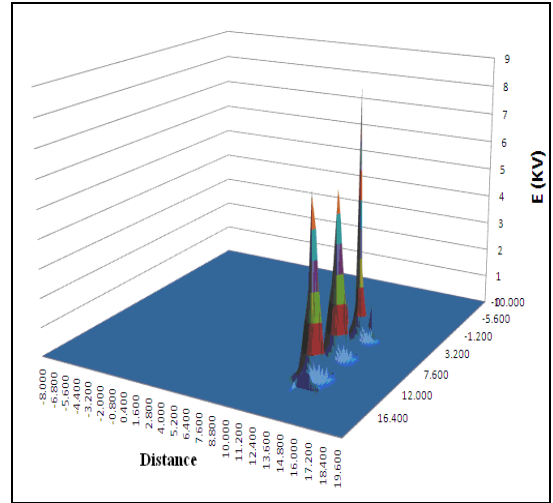
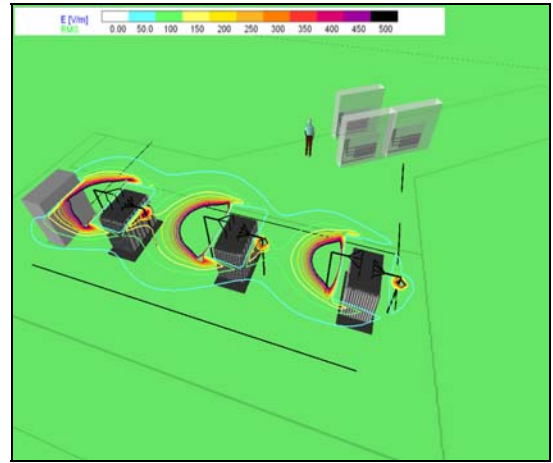

Fig. 4. Distribution of electrical field intensity TS 1 20/0.4 kV– 3D continual distribution

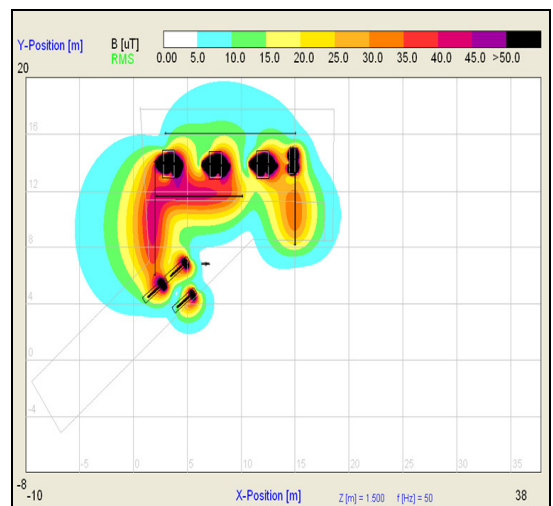

Fig. 5 Distribution of magnetic flux intensity TS 1 20/0.4 kV – 2D continual distribution

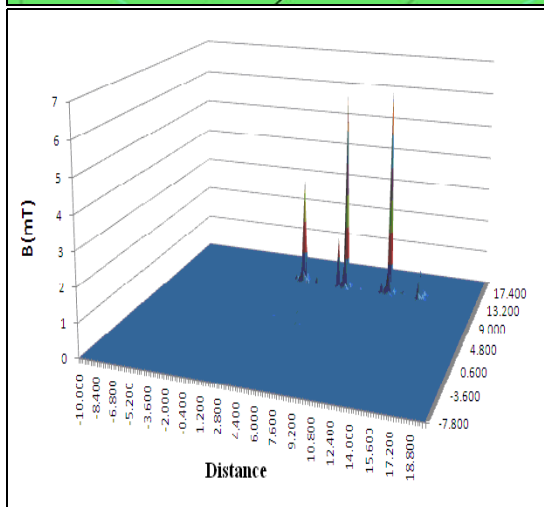
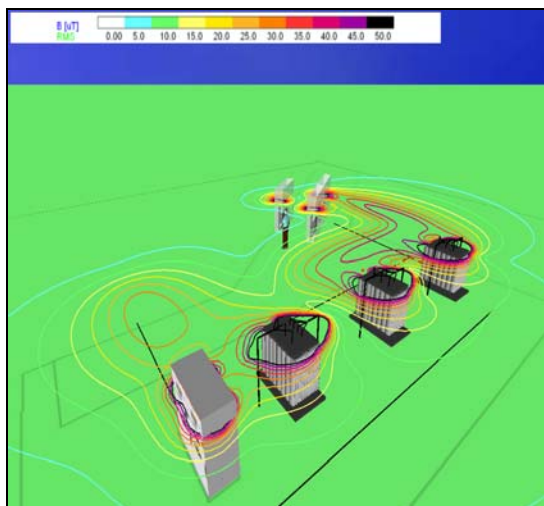

Fig. 6 Distribution of magnetic flux intensity TS 1 20/0.4 kV – 3D continual distribution

**B. TS 2 20/0.4 kV**

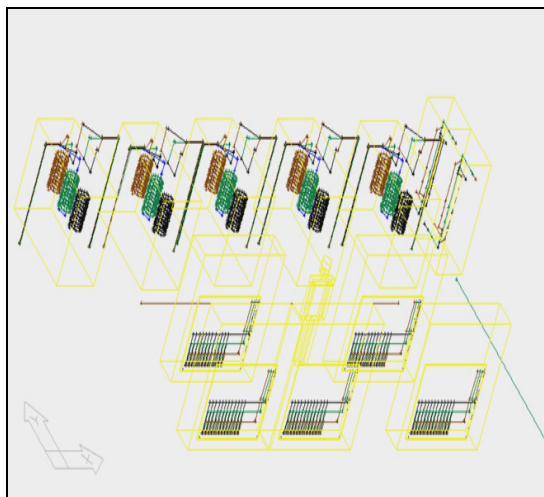

Fig. 7 3D presentation of disposition TS 2 20/0.4 kV in EFC-400 software

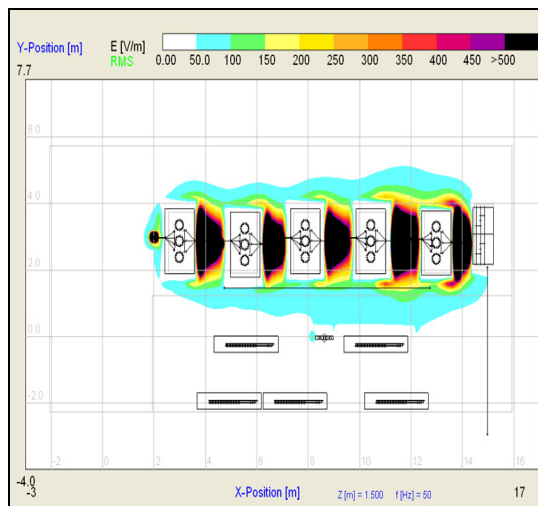

Fig. 8 Distribution of electrical field intensity TS 2 20/0.4 kV – 2D continual distribution

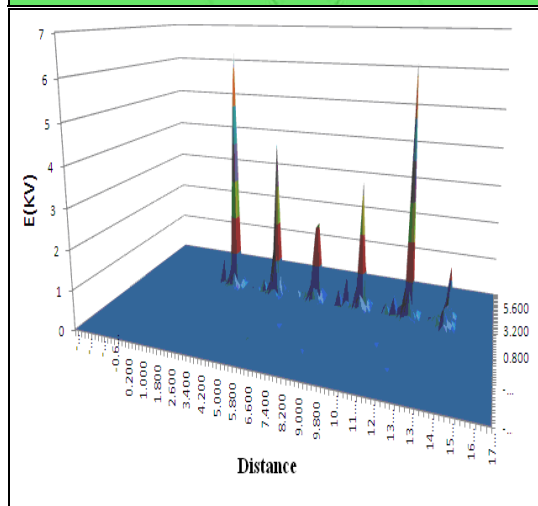
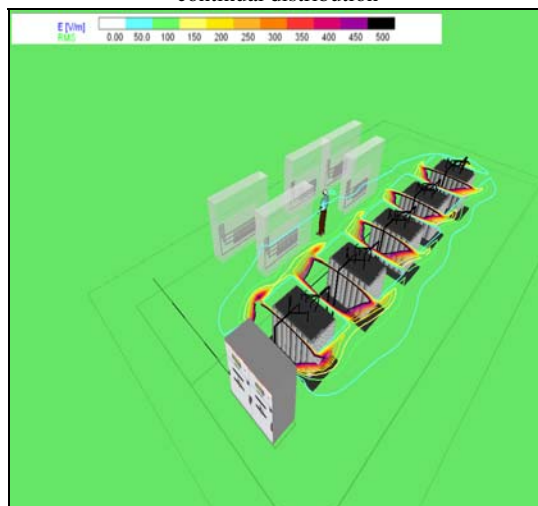

Fig. 9 Distribution of electrical field intensity TS 2 20/0.4 kV – 3D continual distribution

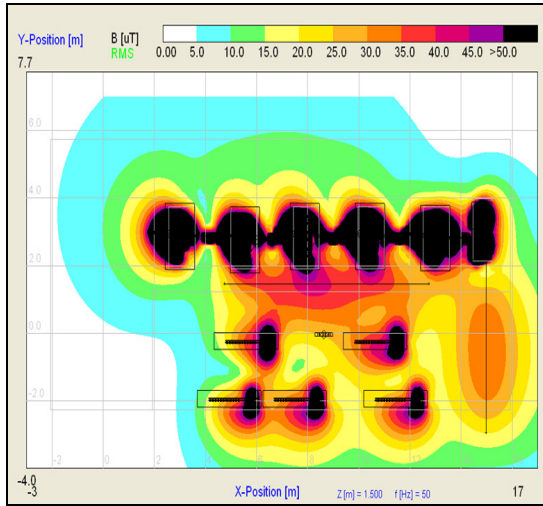

Fig. 10 Distribution of magnetic flux intensity TS 2 20/0.4 kV – 2D continual distribution

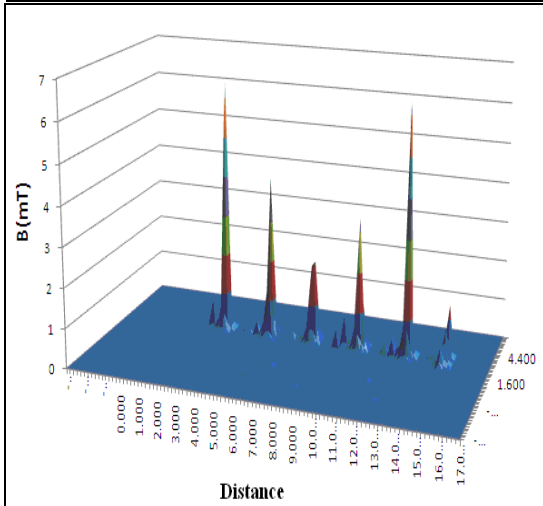
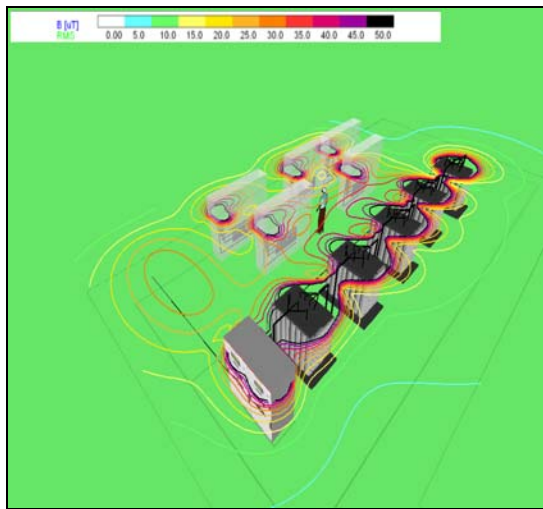

Fig. 11 Distribution of magnetic flux intensity TS 2 20/0.4 kV – 3D continual distribution

C. TS 3 20/0.4 kV

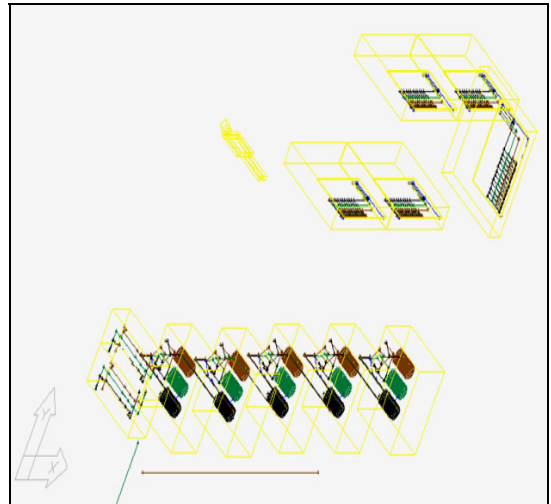

Fig. 12 3D presentation of disposition TS 3 20/0.4 kV in EFC-400 software

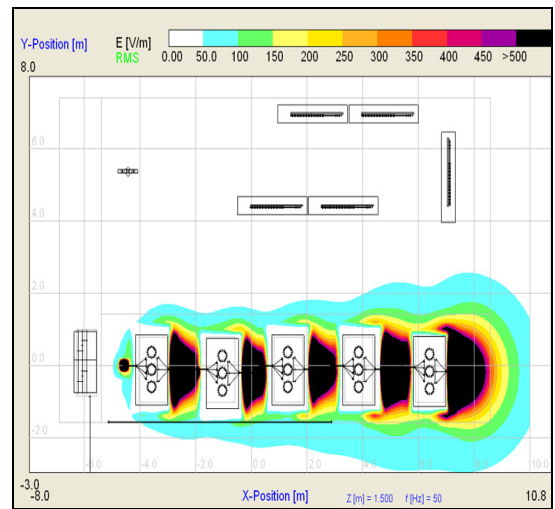

Fig. 13 Distribution of electrical field intensity TS 3 20/0.4 kV – 2D continual distribution

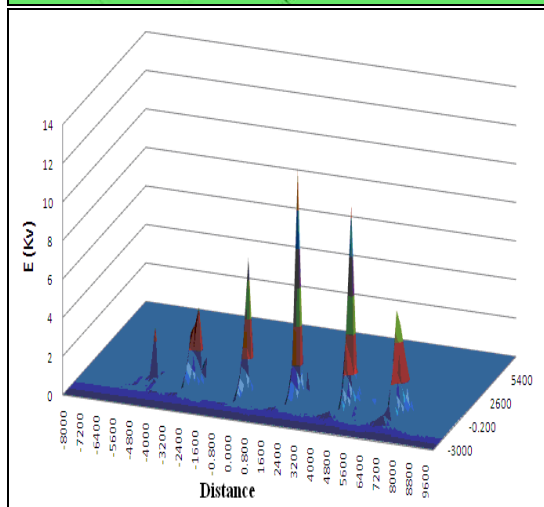
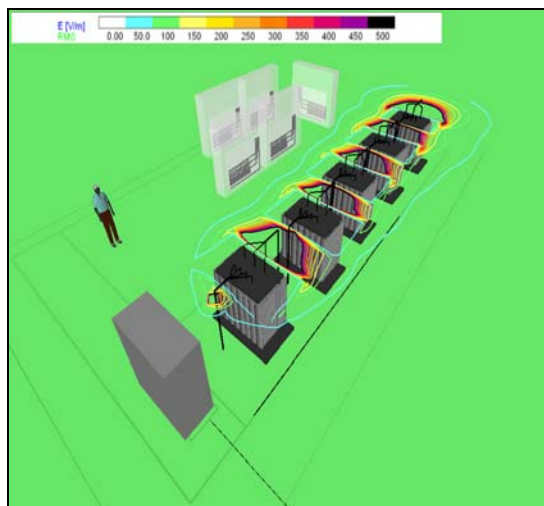

Fig. 14 Distribution of electrical field intensity TS 3 20/0.4 kV – 3D continual distribution

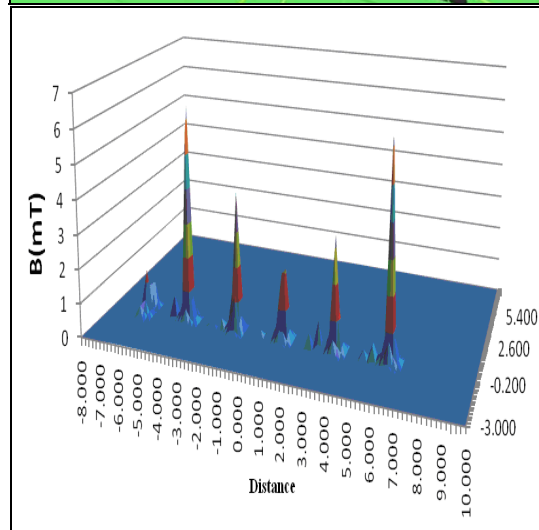
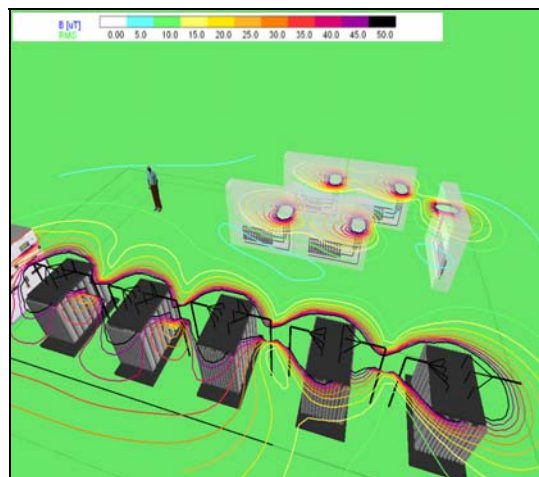

Fig. 16 Distribution of magnetic flux intensity TS 3 20/0.4 kV– 3D continual distribution

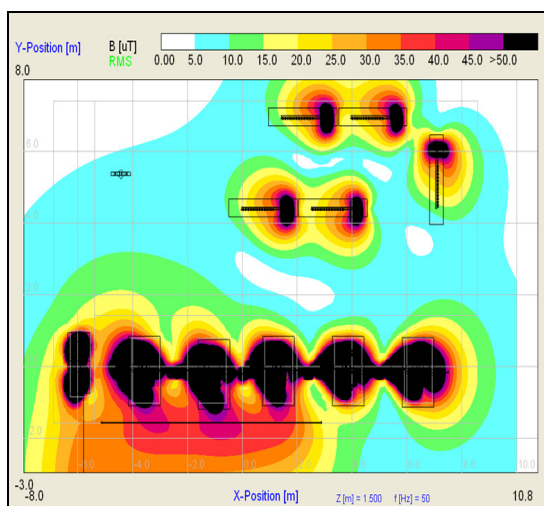

Fig. 15 Distribution of magnetic flux intensity TS 3 20/0.4 kV – 2D continual distribution

Calculation results show that electric field intensity is the highest inside the substation equipment. Maximum values of electric and magnetic field in transformer substation can be noted at the intersection of XY plane at the height of 1.5 m above the ground with transformer clamps of middle-voltage and cable connections of middle-voltage block and primer side of power transformer. With all mentioned details in modeling, electric field intensity is lower than 5 kV/m, which is allowed value for the area of professional exposure. 2 kV/m can be measured inside the equipments in substation, where access in normal operation is disabled. Same values on the very short distance decrease, but at 3-4 m electric field disappears. On figures which show electric field intensity distribution on plateau of substation, border area with electric field intensity smaller than 0.5 kV/m can be noted. Calculation results show that values of magnetic flux density, appearing nearby transformer, are smaller than limiting values prescribed for areas of professional exposure. On distance of about 2 m from transformer values of magnetic flux density decrease under the value of 20  $\mu\text{T}$ , which is much smaller than value of 40  $\mu\text{T}$  prescribed by a norm.

### III. CONCLUSION

This paper presents the calculation of the maximum electric and magnetic field intensity emitted by substation TS 20/0.4 kV (3x1600 kVA, 4x1600 kVA, 5x1600 kVA) TS 1, TS 2 and TS 3 in shopping center. Calculations of effective magnetic flux intensity conducted at the height of 1.5 m above the ground level with maximum current load on some equipment. These loads rarely appear in real operation, which means that the results of calculation are on side of safety. Calculation results and measured values show that intensity of electrical field is below than 0.5 kV/m, while intensity of magnetic flux at the distance of more than 2 m is below 20  $\mu$ T. Since the calculations were made with the values that are higher than values in normal operation, it can be conclude that calculation is on the side of safety and expected values of electrical and magnetic field intensity in normal operation are lower than the limit values prescribed by norms. Presented mathematical model, calculation and visual 3D distribution of electric and magnetic field represent a realistic assumption for study of interactions between electromagnetic fields and human bodies at the macroscopic and static level.

### REFERENCES

- [1] I.Kapetanovic, V.Madzarevic, A.Muharemovic, H.Salkic, "Exposure to Low Frequency Magnetic Fields of a Transformer Station", IJESSE –International Journal of Electrical Systems Science and Engineering, pp. 120-128, ISSN 2070-3953, Volume 1, Number 2, 2008;
- [2] A.Muharemovic, V.Madzarevic, H.Salkic, I.Turkovic, N.Mehinovic, "Calculation of Low-frequency Magnetic Field Distribution of a Transformer Station in Stationary State", International Review on Modelling and Simulations (IREMOS), - December 2009 – Papers, Print ISSN 1974-9821, Cd-Rom ISSN 1974-983X;
- [3] *Guide on EMC in Power Plants and Substations*, CIGRE WG 36.04, Dec. 1997.;
- [4] C.Imposimato, J.Hoeffelman, A.Eriksson, W.H.Siew, P.H.Pretorius, P.S.Wong, "EMI Characterization of HVAC Substations-Updated Data and Influence on Immunity Assessment", CIGRE 2002, paper on behalf of CIGRE/CIREWG 36/S2-04.;
- [5] IEEE Std. 998-1996, "Guide for Direct Stroke Shielding of Substations";
- [6] H.Salkic, Z. Sikira, Z. Salkic, A.Softic, D.Bacinovic, "Elimination of electromagnetic interference in transformer station", 19<sup>th</sup> International expert meeting power engineering, Maribor, 11-13.05.2010.g, Slovenia;
- [7] H. Salkic, V. Madzarevic, A.Muharemovic, N. Mehinovic, "Low-frequency quasi-stationary electromagnetic fields of a transformer station" -International Colloquium Power Frequency Electromagnetic Fields – ELF EMF Sarajevo, Bosnia and Herzegovina, Paper 24, 3-4.6.2009;
- [8] H. Salkic, V.Madzarevic, A.Muharemovic, N. Mehinovic, "Calculation of Low-frequency Magnetic Fields Distribution of a Transformer Station in Stationary State" -XIV international symposium on electromagnetic fields in mechatronics, electrical and electronic engineering – ISEF'2009, 10-12 september 2009. Arras France.
- [9] David Morgan, "A Handbook for EMC", London, 1994;

**Adnan Muharemovic** was born in Sarajevo (Bosnia and Herzegovina) on 29<sup>th</sup> of June, 1986. He finished his B.Sc. and M.Sc. at the University of Sarajevo, where he is currently PhD student. He is currently employed in Energoinvest D.D. Sarajevo. His topics of interest are electromagnetic compatibility in power systems, cathodic protection, electrical measurements, electrical installations and safety measures, and EMC in power systems.

**Hidajet Salkic** was born in Tuzla (Bosnia and Herzegovina) on 09<sup>th</sup> of April, 1963. He received a B.S. degree in Electrical Engineering, M.S. degree and Ph.D. degree from University of Tuzla (Bosnia and Herzegovina). Currently employed at PE Elektroprivreda BiH Sarajevo where he is conducting a series of specialist and management functions, primarily managing development and maintenance of electrical facilities and optimization and development of power distribution components as well as planning and supervising a power consumption. He is also an external associate at University of Tuzla, Faculty of electrical engineering, Department of electrical engineering and energy conversion systems. Field of work: Differential and integral equations for presentation and mathematical modeling and numerical solution of electric and magnetic fields in systems for power production, transmission and distribution, transient phenomena and electromagnetic compatibility in power systems, biological effects of electric and magnetic fields as well as the protection from non ionizing electromagnetic radiation, integrated fields, technical diagnostic, new technologies in electromechanical systems, supervising and regulation of electromotor drives and interaction of power network and prime motors.

**Mario Klaric** (S'04) was born in Sibenik, Croatia in 1979. He finished his B.Sc. and M.Sc. at the University of Zagreb, where he is currently PhD student as well as MBA student. He is currently employed in Dalekovod d.d. Zagreb. His area of interest is wind power and grid integration of renewable energy sources. He is a student member of IEEE as well as member of Croatian committees of CIGRE and WEC.

**Irfan Turkovic** was born in Konjic (Bosnia and Herzegovina) on August 07, 1962. He received a B.S. degree in Electrical Engineering, M.S. degree and Ph.D. degree from University of Sarajevo (Bosnia and Herzegovina), in 1986, 2003 and 2010, respectively. From 1986 he has been working at the Faculty of Electrical Engineering, University of Sarajevo. His topics of interest are Cathodic protection, Electrical measurements, Safety in low voltage network and EMC in Power Systems.

**Aida Muharemovic** was born in Sarajevo (Bosnia and Herzegovina) on 29<sup>th</sup> of June, 1986. She received a B.S. degree in Electrical Engineering, M. S. degree from University of Sarajevo (Bosnia and Herzegovina), in 2009, and 2011, respectively. Her topics of interest are electromagnetic compatibility in power systems, cathodic protection, electrical measurements, electrical installations and safety measures, and EMC in power systems. She is currently employed in BH Telecom.