

# Mathematical Modeling of Current Harmonics Caused by Personal Computers

Rana Abdul Jabbar Khan, and Muhammad Akmal

**Abstract**—Personal computers draw non-sinusoidal current with odd harmonics more significantly. Power Quality of distribution networks is severely affected due to the flow of these generated harmonics during the operation of electronic loads. In this paper, mathematical modeling of odd harmonics in current like 3<sup>rd</sup>, 5<sup>th</sup>, 7<sup>th</sup> and 9<sup>th</sup> influencing the power quality has been presented. Live signals have been captured with the help of power quality analyzer for analysis purpose. The interesting feature is that Total Harmonic Distortion (THD) in current decreases with the increase of nonlinear loads has been verified theoretically. The results obtained using mathematical expressions have been compared with the practical results and exciting results have been found.

**Keywords**—Harmonic Distortion, Mathematical Modeling, Power Quality.

## I. INTRODUCTION

**H**ARMONICS are the sinusoidal currents or voltages having frequencies that are integer multiples of the frequency at which the supply system is designed to operate [1]. In electrical engineering harmonics are described as follows (IEEE 1159-1995).

The awareness of the root cause of harmonics generation from nonlinear loads like PC's, TV's, VCR's etc and their impacts on normal operation of power system like [2, 3, 4, 5, 6, 7, 8, 9, 10].

- Deterioration of insulation
- Increase in power losses
- Shortening life span of electrical installations
- Shutdowns
- Misoperation of sensitive equipment
- Capacitor failures
- Communication interference
- Overheating of transformers
- Overloading of neutral conductor
- Harmonic resonance
- Maloperation of electronic equipment
- Distorted supply voltage
- System voltage dips
- Protection trippings
- AC/DC drives failure

Authors are with Rachna College of Engineering and Technology, Gujranwala, Pakistan (e-mail: principal@rcet.edu.pk, engrakmal@hotmail.com).

Many researchers todate have decomposed the distorted waveforms due to the presence of harmonics using various techniques such as FFT, Wavelet transform etc for analysis purpose while decomposing the distorted waveform from time to frequency domain [11].

In this paper the odd harmonics (3<sup>rd</sup>, 5<sup>th</sup>, 7<sup>th</sup>, 9<sup>th</sup>) have been modelled mathematically to understand their individual behaviour with increase of nonlinear loads. This innovative approach will really be useful for scientific community to access the influence of the factor in form of odd harmonics influencing the power quality.

In order to get data practically live tests were carried out at RCET research laboratory. Different harmonics especially the 3<sup>rd</sup> harmonic flowing through conductor contributed significantly. Therefore special consideration for monitoring and modelling of harmonics in power systems is necessary to address such issues in future.

Section 2 explains the methodology along with instrumentation and course adopted during the experimental work. Section 3 highlights the practical results and discussion carried out. Section 4 narrates the graphical representation of individual odd harmonics and THD in current elaborated by mathematical expressions. In section 5 the calculated values from the mathematical expressions have been compared with the observed results. Section 6 presents conclusions drawn from this research work. Last Section gives all the references used throughout this research paper.

## II. METHODOLOGY AND INSTRUMENTATION

In this work various computers were connected to the main of the power supply one by one and effect of each computer on the current waveform of the main was recorded.

Fig. 1 indicates the hardware arrangement and apparatus used during the experimental work.

As is evident from Fig. 1, inputs for various computers under test one by one are drawn from AC mains. The waveforms of odd harmonics and THD have been observed and recorded. This data has been used to make observations about the changes and effects of electronic loads.

Following equipment have been used for the research work.

i) Power quality analyzer was used to record the current waveforms and THD.

ii) Personal Computer (PC) details are as under:

Pentium (R) 4 CPU 2.40 GHz  
 ATX Power supply 220 to 230 Volts  
 Monitor 15 inch (100- 240V, 50/60Hz,  
 0.8- 1.5A)

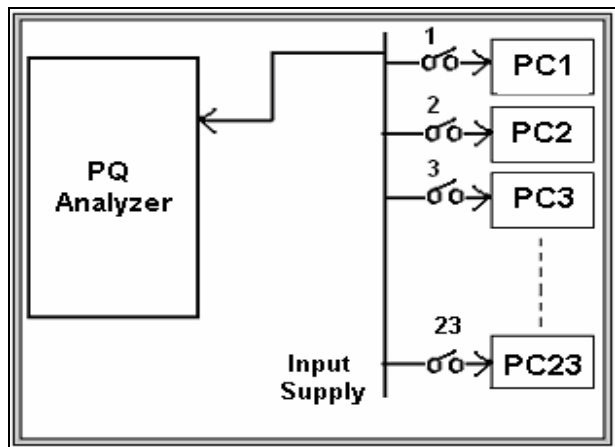

Fig. 1 Hardware arrangement

### III. RESULTS AND DISCUSSIONS

PC's numbering from PC1 to PC23 were connected to the AC mains gradually and then wave-forms of odd harmonics and THD in current have been captured and recorded in real time for observations. Table I describes the results taken for Total Harmonic Distortion (THD) in current and individual magnitudes of odd harmonics corresponding to different no. of PCs connected to the main.

TABLE I  
 ONLINE RECORDED RESULTS

No. of PCs	%age Magnitude of 3 <sup>rd</sup> Harmonic	%age Magnitude of 5 <sup>th</sup> Harmonic	%age Magnitude of 7 <sup>th</sup> Harmonic	%age Magnitude of 9 <sup>th</sup> Harmonic	%age THD in Current
1	50	45	37	24	79.3
4	53	42	25	13	74.6
7	54	40	21	5	72.3
10	56	38	16	3	70.1
13	58	35	12	2	68.6
16	58	33	8	5	66.2
19	57	29	6	7	64.0
21	58	27	4	7	62.8
23	58	25	0	9	61.4

### VI. GRAPHICAL REPRESENTATION OF RESULTS

#### A. 3<sup>rd</sup> Harmonic Only

From graph shown in Fig. 2, it is clear that the magnitude of 3<sup>rd</sup> harmonic increases upto certain level then it remains constant with further increase of the electronic load.

Mathematically, using Curve Fitting technique, the relation between columns 1 and 2 of Table I can be written as [12]

$$y = -0.0248x^2 + 0.935x + 49.228$$

In the form of current and number of PCs.

$$I_3 = -0.0248N_{PC}^2 + 0.935N_{PC} + 49.228 \quad (i)$$

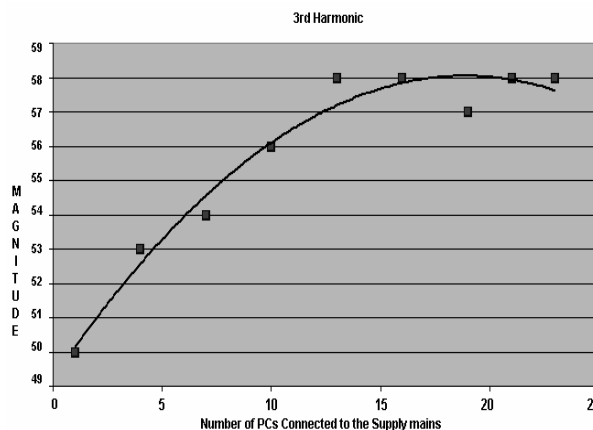

Fig. 2 Graphical representation of 3<sup>rd</sup> harmonic only

#### B. 5<sup>th</sup> Harmonic Only

From graph shown in Fig. 3, the magnitude of 5<sup>th</sup> harmonic decreases in linear fashion, as the number of PC's connected to the supply mains increases, ultimately the magnitude of this odd harmonics approaches to zero.

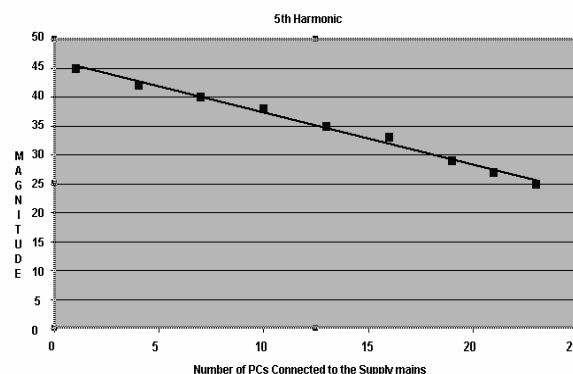

Fig. 3 Graphical representation of 5<sup>th</sup> harmonic only

Mathematically, using Curve Fitting technique relation between columns 1 and 3 of Table I can be written as:

$$y = -0.8961x + 46.239$$

In the form of magnitude of harmonic current and the no. of PCs connected to the supply mains:

$$I_5 = -0.8961N_{PC} + 46.239 \quad (ii)$$

Where

- 0.8961 is the slop of the line  
 46.239 is its y-intercept

C. 7<sup>th</sup> Harmonic Only

Fig. 4 indicates that the magnitude of 7<sup>th</sup> harmonic decreases in a logarithmic fashion, rather than linear as in the case of 3<sup>rd</sup> and 5<sup>th</sup> harmonic, as the number of PC's increases and consequently it becomes zero.

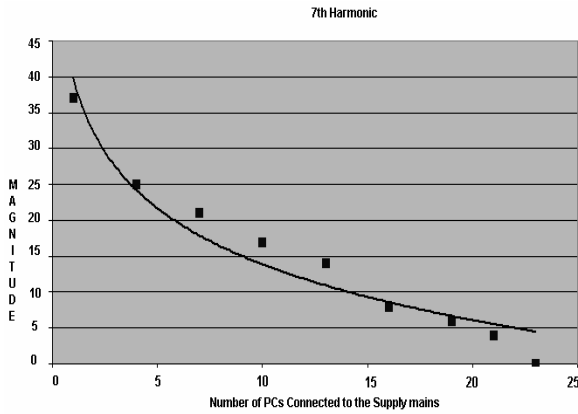

Fig. 4 Graphical representation of 7<sup>th</sup> harmonic only

Mathematically, using Curve Fitting technique relation between columns 1 and 4 of Table I can be written as:

$$y = -11.278 \ln(x) + 39.85$$

In the form of magnitude of harmonic current and the no. of PCs connected to the supply mains:

$$I_7 = -11.278 \ln(N_{PC}) + 39.85 \quad (iii)$$

Where  $\ln(x)$  is a natural logarithmic function.

D. 9<sup>th</sup> Harmonic Only

From this graph shown in Fig. 5, it is observed that the magnitude of 9<sup>th</sup> harmonic is following the trend line of polynomial of order 2 as compared to other harmonics as the number of PC's is increasing the magnitude of 9<sup>th</sup> harmonic is decreasing resultantly.

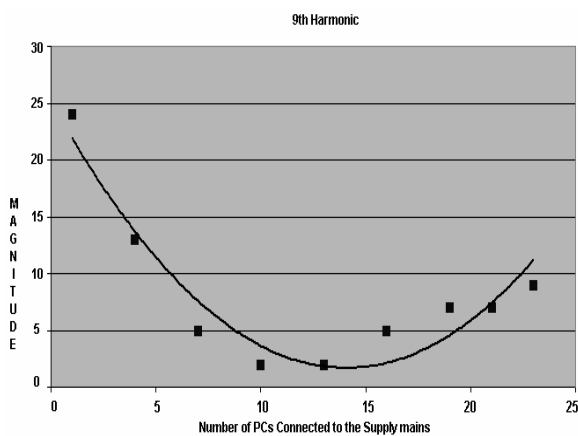

Fig. 5 Graphical representation of 9<sup>th</sup> harmonic only

Mathematically, using Curve Fitting technique relation between columns 1 and 5 of Table I can be written as

$$y = 0.1188x^2 - 3.3403x + 25.159$$

In the form of magnitude of harmonic current and the no. of PCs connected to the supply mains:

$$I_9 = 0.1188N_{PC}^2 - 3.3403N_{PC} + 25.159 \quad (iv)$$

Where the expression on right hand side is a polynomial of 2<sup>nd</sup> order, geometrically it represents the characteristics of parabolic curve.

E. THD in Current

The percentage of Total Harmonic Distortion (%THD) can be defined in two different ways, as a percentage of the fundamental component (the IEEE definition of THD) or as a percentage of the rms (used by the Canadian Standards Association and the IEC) [14].

$$THD = \frac{\sqrt{\sum_{n=2}^{\infty} I_{rms,n}^2}}{I_1}$$

Where  $I_{rms,n}$  is the amplitude of the harmonic component of order n (i.e., the nth harmonic). The numerator gives the RMS current due to all harmonics and  $I_1$  is the RMS value of fundamental component of current only.

Given above is the mathematical form of the IEEE definition of THD [13].

According to IEC standards, the mathematical form of THD is given below [6]:

$$THD = \frac{\sqrt{\sum_{n=2}^{\infty} I_{rms,n}^2}}{I_{rms}}$$

Where,

$$I_{rms} = \sqrt{\sum_{n=1}^{\infty} I_{rms,n}^2}$$

Where  $I_{rms,n}$  is the amplitude of the harmonic component of order n (i.e., the nth harmonic) and  $I_{rms}$  is the rms value of all the harmonics plus the fundamental component of the current. The later standard is referred in this study, because the apparatus used for analysis was based on IEC Standards. The 3<sup>rd</sup>, 5<sup>th</sup>, 7<sup>th</sup> and 9<sup>th</sup> harmonics being the most significant, the definition of THD may be modified and written as in the next page.

$$THD = \frac{\sqrt{I_{rms,3}^2 + I_{rms,5}^2 + I_{rms,7}^2 + I_{rms,9}^2}}{I_{rms}} \quad (A)$$

The value of THD may be calculated for any number of computers using the above formula. Fig. 6 is showing the magnitude of individual harmonics, when 4 PCs were connected to the supply mains.

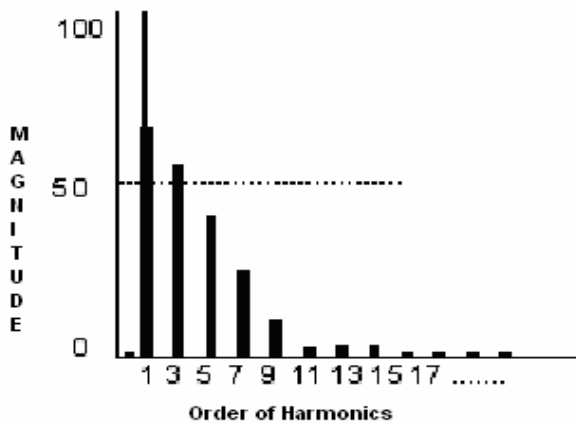

Fig. 6 FFT of current waveform

$$I_{rms} = 3.28 \text{ A}$$

RMS magnitude of 3<sup>rd</sup> Harmonic=53% of 3.28= 1.7384 A  
 RMS magnitude of 5<sup>th</sup> Harmonic=42% of 3.28 = 1.3776 A  
 RMS magnitude of 7<sup>th</sup> Harmonic=25% of 3.28= 0.8200 A  
 RMS magnitude of 9<sup>th</sup> Harmonic=13% of 3.28= 0.4264 A

$$THD = \frac{\sqrt{(1.7384)^2 + (1.3776)^2 + (0.8200)^2 + (0.4264)^2}}{3.28}$$

$$THD = 73.26\%$$

Equation (A) can be modified as below:

$$THD = \sqrt{\frac{I_{rms,3}^2}{I_{rms}^2} + \frac{I_{rms,5}^2}{I_{rms}^2} + \frac{I_{rms,7}^2}{I_{rms}^2} + \frac{I_{rms,9}^2}{I_{rms}^2}}$$

Which can further be written as:

$$THD = \sqrt{I_3^2 + I_5^2 + I_7^2 + I_9^2} \quad (B)$$

Where  $I_3, I_5, I_7$  and  $I_9$  are the %age magnitudes of the 3<sup>rd</sup>, 5<sup>th</sup>, 7<sup>th</sup> and 9<sup>th</sup> harmonics respectively. In this case it can be calculated as:

$$THD = \sqrt{53^2 + 42^2 + 25^2 + 13^2}$$

$$THD = 73.26\%$$

In the Table I, the online value of THD is 74.6%. The difference of the calculated and experimental value is 1.34,

which is only 1.8%. This negligible difference caused by other odd harmonics being neglected proves the validity of measurement and it consequently plays a pivotal role for the accurate analysis of the odd harmonics under test in this research.

Fig. 7 explains the overall impact of individual harmonics cumulatively. Total Harmonic Distortion (THD) in Current with increase in electronic loads is decreasing. As discussed in previous sections, among odd harmonics only third harmonic plays active role whereas the other odd harmonics impact with increase in electronic loads is negligible [14].

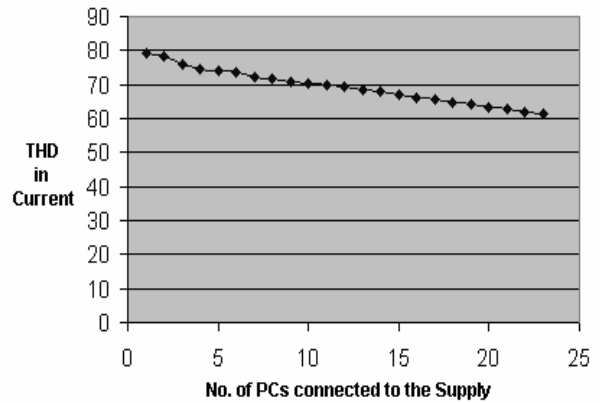

Fig. 7 Graphical representation of THD in current

The relation between THD in current and the number of PCs is already developed in [14] and is given below:

$$I_t = 80.11 - 0.81 \times N_{pcs}$$

The relation was not justified in [14] but the analysis of individual harmonics performed in this paper justifies this relation too, as all individual harmonic components except 3<sup>rd</sup> harmonic are decreasing with the increasing number of PCs.

#### V. JUSTIFICATION OF MATHEMATICAL MODELS

Odd harmonic currents can be calculated for any desired number of PCs using equations (i) to (iv) given in previous section. The obtained values of odd harmonics can be used to calculate THD in current using equation (B). For 10 PCs, the calculated values of 3<sup>rd</sup>, 5<sup>th</sup>, 7<sup>th</sup> and 9<sup>th</sup> harmonic currents are given below:

$$I_3 = 56.09 \%$$

$$I_5 = 37.28 \%$$

$$I_7 = 13.88 \%$$

$$I_9 = 3.636 \%$$

$$THD = \sqrt{56.09^2 + 37.28^2 + 13.88^2 + 3.636^2}$$

$$THD = 68.86 \%$$

Following the same pattern for any number of PCs connected to the supply mains, percentage of odd harmonics and THDI can be calculated as follows:

TABLE II  
COMPARISON OF CALCULATED AND EXPERIMENTAL VALUES

No. of PCs	Parameters description	Calculated values	Experimental values	%age Error
10	I <sub>3</sub>	56.09	56.00	0.16
	I <sub>5</sub>	37.28	38.00	1.89
	I <sub>7</sub>	13.88	16.00	13.25
	I <sub>9</sub>	3.636	3.000	2.12
	THDI	68.86	70.10	1.80
13	I <sub>3</sub>	57.19	58.00	1.40
	I <sub>5</sub>	34.59	35.00	1.17
	I <sub>7</sub>	10.92	12.00	9.00
	I <sub>9</sub>	1.812	2.000	9.40
	THDI	67.75	68.60	1.23

Last column of Table II reveals the ignorable values of error; all this confirms the authenticity of the developed mathematical models.

## VI. CONCLUSION

During the research presented in this paper, individual assessment of odd harmonics in current; significant in magnitudes are represented by mathematical modeling and proved theoretically the decrease in THD in current with the increase of electronic/nonlinear loads connected to the distribution network.

Keeping in view predicted magnitudes by virtue of mathematical modeling, this innovative technique will certainly draw the attention of researchers, consumers, utilities and the manufacturers to think about the remedial measures for mitigation of this undesired phenomenon for smooth operation of power distribution network.

## REFERENCES

- [1] D. Daniel Sabin, Daniel L. Brooks and Ashok Sundaram, "Indices for Assessing Harmonic Distortion from Power Quality Measurements: Definitions and Benchmark data", *IEEE Transactions on Power Delivery*, Vol.14, No. 2, April 1999, pp. 489-496.
- [2] M. Al-Dabbagh, H. Askarian and Rana Abdul Jabbar Khan, "Power Quality and Energy Loss Reduction in Power Systems", *AUPEC'01*, 23-26 September 2001, pp. 130-135.
- [3] Joseph S. Subjak, Jr, and John S. Mcquielkin, "Harmonics-causes, effects, measurements, and analysis update", *IEEE Transaction on Industry Applications*, Volume: 26 issue: 6, Nov.-Dec. 1990, pp. 1034-1042.
- [4] Integral energy power quality, Australia: Technical Note No.3, "Harmonic distortion in the electric supply system", March 2000, pp.1-10.
- [5] IEEE Std. 512-1992, "IEEE recommended practices and requirements for harmonic control in electrical power systems", IEEE April 12, 1993.
- [6] IEEE Std. 1159-1995, "IEEE recommended practice for monitoring electric power quality", IEEE, New York, 1995.

- [7] Derek Maule, "Regulating mains pollution", *IEE Review* March 2001, pp.35-38.
- [8] Don O. Koval and Clive Carter, Power Quality Characteristics of Computer Loads, *IEEE Transactions on Industry Applications*, VOL. 33, NO. 3, May/June 1997, pp.613-621.
- [9] W. Mack Grady, Arshad Mansoor, Ewald F. Fuchs, Paola Verde and Michael Doyle, Estimating the Net Harmonic Currents Produced by Selected Distributed Single-Phase Loads: Computers, Televisions, and Incandescent Light Dimmers, ISBN # 0-7803-7322-7 pp.1090-1094.
- [10] A. Mansoor, W. M. Grady, A. H. Chowdhury, M. J. Samotyj, An Investigation of Harmonics Attenuation and Diversity Among Distributed Single-phase Power Electronic Loads, *IEEE Transactions on Power Delivery*, Vol. 10, No. 1, January 1995, pp.467-473.
- [11] Rana Abdul Jabbar Khan and Majid Al-Dabbagh, "Decomposition of Power Systems Harmonics by Wavelet Technique", *AUPEC*, 03, New Zealand, 26-28 October. 2003, ISBN # 0-473-09867-9.
- [12] Erwin Kreyszig, "Advanced Engineering Mathematics", 8<sup>th</sup> Edition, ISBN 9971-51-283-1, pp. 914-916.
- [13] RAJ Khan, "Power Quality and On-line Harmonics Monitoring in Power Systems", *PhD Thesis*, 2003 RMIT University Australia, pp 117.
- [14] Rana A. Jabbar, Suhail A. Qureshi, M. Akmal, Waqar Qureshi, Abrar Ahmad, "Practical Analysis and Mathematical Modeling of Harmonic Distortions Caused by Electronic Loads", *Proc. 7<sup>th</sup> IASTED Conf. on Power and Energy Systems ~EuroPES 2007~* Palma de Mallorca, Spain, ISBN# 978-0-88986-689-8, pp. 151-156.

**Rana Abdul Jabbar Khan** was born in Gujranwala, Pakistan, in 1966. He received his B.Engg. M.Engg. and PhD from UET Pakistan, University of Wollongong Australia and RMIT University Australia, in 1991, 1996 and 2003 respectively. Currently he is serving as Principal of Rachna College of Engineering & Technology Gujranwala, Pakistan. His research interests include Power Quality, Power System Simulation, and Deregulation of Electricity etc.

**Muhammad Akmal** was born in Faqirwali, Pakistan in 1983. He did his B.Sc. Electrical Engineering from UET Lahore, Pakistan in 2006. Since then, he is serving as Lecturer, at Rachna College of Engineering and Technology, Gujranwala, and continuing his MSc in Power Engineering from UET Lahore. He is a member of research team at RCET. His research interests include Power Quality, Microgrids, Smart grid infrastructures and Distributed Generation etc.