

# Investigating Performance of Numerical Distance Relay with Higher Order Antialiasing Filter

Venkatesh C., K. Shanti Swarup

**Abstract**—This paper investigates the impact on operating time delay and relay maloperation when 1<sup>st</sup>, 2<sup>nd</sup> and 3<sup>rd</sup> order analog antialiasing filters are used in numerical distance protection. RC filter with cut-off frequency 90 Hz is used. Simulations are carried out for different SIR (Source to line Impedance Ratio), load, fault type and fault conditions using SIMULINK, where the voltage and current signals are fed online to the developed numerical distance relay model. Matlab is used for plotting the impedance trajectory. Investigation results shows that, about 75 % of the simulated cases, numerical distance relay operating time is not increased even-though there is a time delay when higher order filters are used. Relay maloperation (selectivity) also reduces (increases) when higher order filters are used in numerical distance protection.

**Keywords**—Antialiasing, capacitive voltage transformers, delay estimation, discrete Fourier transform (DFT), distance measurement, low-pass filters, source to line impedance ratio (SIR), protective relaying.

## I. INTRODUCTION

**A**NALOG antialiasing filter plays a important role in filtering high frequency, unwanted information from voltage and current signals taken from secondary terminals of capacitive voltage transformer and current transformer respectively. It is usually located between the isolation transformer and sampling unit. The selection of cut-off frequency for analog antialiasing filter depends upon the kind of information required, i.e. fundamental component or higher order harmonics, which is required in case of transformer differential protection. Conventional distance relay algorithm extracts fundamental frequency information from voltage and current signals for impedance estimation by phase and ground elements. Even-though full cycle discrete Fourier transform rejects dc as well as integer multiples of fundamental frequency information, analog antialiasing filter is still used, since the cut-off frequency  $f_c$  of analog antialiasing filter decides the sampling rate  $f_s$ , which should be twice the cut-off frequency, i.e.  $f_s \geq 2f_c$  to avoid aliasing in frequency domain [1]. Removing analog filter in protective relays may result in aliasing, if very high sampling rate is not used, but high sampling rate demands for high processing speeds as the time between samples reduces and the distance relay has to perform fault detection, faulty phase identification, trip decision, background communications, automation and man-machine interface [2], [3] before the next sample arrives, which may increase the cost of the relay.

Venkatesh C and K Shanti Swarup are with the Department of Electrical Engineering, Indian Institute of Technology Madras, India, 600036. (email to ee10d036@smail.iitm.ac.in, ksswarup@iitm.ac.in).

## II. LITERATURE REVIEW

Even though the theory and design behind analog filtering is well established, the selection and detailed design of analog antialiasing filter for protection application is found to be limited from literature point of view. Performance of distance relay, with and without analog antialiasing filter is carried out in [4], but this analysis is done only for single line to ground faults, only at 80% of line length, without change in sampling frequency and considering voltage transformer instead of capacitive voltage transformer. The main drawback in this analysis is, the high frequency transients which occur in the first post fault cycle [5], [6] in voltage signal is not considered. Reference [7] compares the magnitude response of Butterworth, Chebyshev and RC analog antialiasing filters for protection application. Reference [7], [8] pinpoints that, the use of filter with sharp cut-off frequency i.e. higher order filter will introduce more time delay. Sampling frequency of 48 kHz (960 samples per cycle) used in [8] (CVT not considered) not only increases the computational complexity (N point DFT involves  $N^2$  complex multiplication and  $N(N-1)$  complex addition where, N is the number of samples per cycle) when compared to 600Hz (12 samples per cycle), but also demands increase in memory size to store more sample values, DFT matrix ( $N^2$  matrix elements are stored for N point DFT). It also demands for multiplexer with high speed channel switching time, which on the whole may increase the cost. This increased cost may defeat one of the reason (cost) for opting oversampling instead of analog antialiasing filter. The second reason i.e. delay time which is mentioned as the other reason for opting oversampling [8] is investigated in this paper.

Even-though it is obvious that, use of higher order filters introduce more time delay in phasor computation, no analysis is done in the past, to compare the operating time delay and relay maloperation (selectivity) when analog antialiasing filter with different filter orders are used for numerical distance protection. Since two stage RC filter is used in general [7], investigation here on numerical distance protection is carried out with 1<sup>st</sup> order, 2<sup>nd</sup> order and 3<sup>rd</sup> order analog antialiasing filter.

The outline of the paper is as follows, section III deals with the design of 1<sup>st</sup> order, 2<sup>nd</sup> order and 3<sup>rd</sup> RC filter followed by Section IV which deals with the system which is considered for this study and describes the components of developed numerical distance relay model. Section V shows simulation results obtained by considering different possible cases followed by Section VI with observations, inferences and finally conclusion.

### III. DESIGN OF 1<sup>st</sup>, 2<sup>nd</sup>, 3<sup>rd</sup> ORDER RC FILTER

RC filter is chosen for this investigation, since it has the least settling time for step input, and no overshoot when compared with other filters. Fig.1 shows the step response of Chebyshev I, Chebyshev II, Elliptical, RC and Butterworth 3<sup>rd</sup> order analog antialiasing filters. Settling time and overshoot plays a important role in filter selection since the numerical distance relay tripping decision depends on the fundamental frequency information of voltage and current signals in the first post fault cycle.

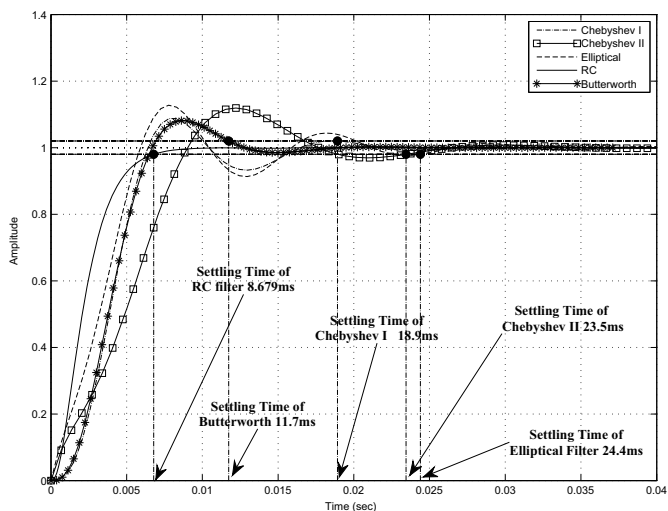

Fig. 1: Step Response of analog antialiasing filters

Since the distance relay main algorithm needs only fundamental frequency (50 Hz) information from voltage and current signals, the cut-off frequencies for 1<sup>st</sup>, 2<sup>nd</sup> and 3<sup>rd</sup> order filters are chosen as 90Hz [4]. Fig.2 shows a typical model of RC filter, where the R<sub>1</sub> value is estimated using equations (1), (2) and (3) for 1<sup>st</sup>, 2<sup>nd</sup> and 3<sup>rd</sup> order filter respectively, with assumptions [7] as indicated in Table I.

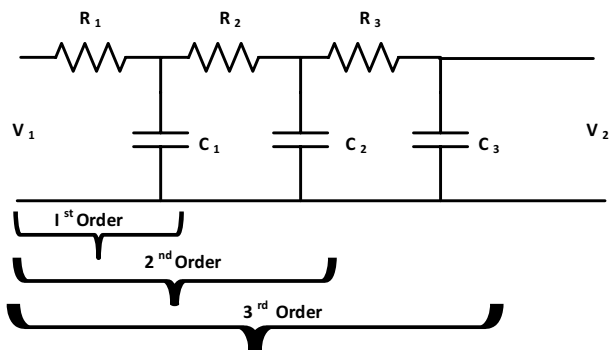

Fig. 2: Model of RC filter

$$\frac{1}{\sqrt{1 + (R_1 C_1 \omega)^2}} = 0.707 \quad (1)$$

$$\frac{1}{\sqrt{(1 - 2^2 R_1^2 C_1^2 \omega^2)^2 + (4 R_1 C_1 \omega)^2}} = 0.707 \quad (2)$$

$$\frac{1}{\sqrt{(1 - 18 R_1^2 C_1^2 \omega^2)^2 + (8 R_1 C_1 \omega - 8 R_1^3 C_1^3 \omega^3)^2}} = 0.707 \quad (3)$$

where  $\omega$  is the angular frequency in rad/sec.

TABLE I  
ESTIMATED VALUES OF R<sub>1</sub>

Filter Order	R <sub>1</sub> (Ω)	Assumption
1 <sup>st</sup>	17683.88257	C <sub>1</sub> = 0.1μF
2 <sup>nd</sup>	5039.5	C <sub>1</sub> = 0.1μF, C <sub>2</sub> = 0.1μF, R <sub>2</sub> = 2R <sub>1</sub>
3 <sup>rd</sup>	3040	C <sub>1</sub> = 0.1μF, C <sub>2</sub> = C <sub>1</sub> , C <sub>3</sub> = C <sub>1</sub> R <sub>2</sub> = 2R <sub>1</sub> , R <sub>3</sub> = 2R <sub>2</sub>

Fig. 3 shows the magnitude and phase responses of 1<sup>st</sup>, 2<sup>nd</sup> and 3<sup>rd</sup> order low pass analog antialiasing filters obtained using the estimated values of R<sub>1</sub> as listed in Table.I and assumed value of C<sub>1</sub>. The phase lag for 1<sup>st</sup>, 2<sup>nd</sup> and 3<sup>rd</sup>

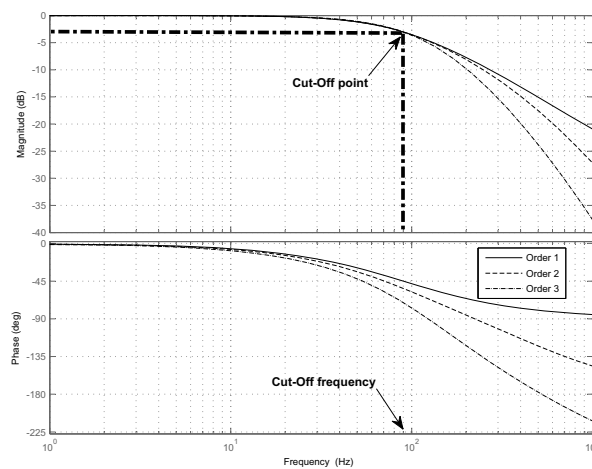

Fig. 3: Magnitude and phase response of 1<sup>st</sup>, 2<sup>nd</sup> and 3<sup>rd</sup> analog antialiasing filter

order filters at fundamental frequency (50Hz) are obtained from phase response plot. The phase lag and the corresponding time delay in ms are listed in Table. II for 1<sup>st</sup>, 2<sup>nd</sup> and 3<sup>rd</sup> order filters.

TABLE II  
FILTER TIME DELAY AT FUNDAMENTAL FREQUENCY (50 Hz)

Filter Order	Phase in deg	Delay in ms
1 <sup>st</sup>	-29.8	1.65
2 <sup>nd</sup>	-34	1.8
3 <sup>rd</sup>	-42.5	2.36

It is also observed from Fig. 3 that, the use of higher order filters results in increased time delay even-though it provides sharp transition from pass band to stop band which is one of the requirement for protective relay, but this introduces time delay in phasor estimation by discrete Fourier transform which is expected to cause delay in relay operating time. The step response of 1<sup>st</sup>, 2<sup>nd</sup> and 3<sup>rd</sup> order filters are obtained by taking partial fractions of (4), (5) and (6) for step input and taking inverse Laplace transform, which finally yields (7), (8) and (9).

$$G_1(s) = \frac{1}{0.001768s + 1} \quad (4)$$

$$G_2(s) = \frac{1}{5.079 \times 10^{-7}s^2 + 0.002016s + 1} \quad (5)$$

$$G_3(s) = \frac{1}{as^3 + bs^2 + cs + d} \quad (6)$$

where,  $G_1(s)$ ,  $G_2(s)$ ,  $G_3(s)$  are the transfer function of 1<sup>st</sup>, 2<sup>nd</sup> and 3<sup>rd</sup> order filter respectively,  
 $a = 2.2.248 \times 10^{-10}$ ,  $b = 1.663 \times 10^{-6}$ ,  
 $c = 0.002432$  and  $d = 1$

$$V_2(t) = 1 - e^{-565.4866775t} \quad (7)$$

$$V_2(t) = 1 - e^{-1984.055118t} \cosh(1402.843817t) - e^{-1984.055118t} \sinh(1402.843817t) \quad (8)$$

$$V_2(t) = 1 - 0.1056e^{-4305.97655t} + e^{-1644.73842t} - 1.8944e^{-628.2335711t} \quad (9)$$

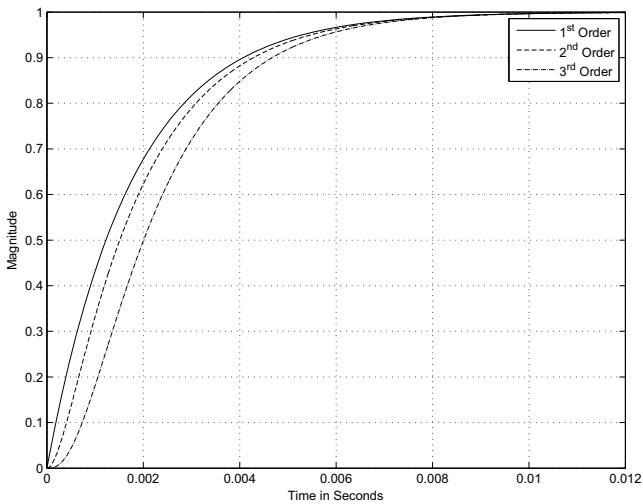

Fig. 4: Step response of 1<sup>st</sup>, 2<sup>nd</sup> and 3<sup>rd</sup> order analog antialiasing filter

Fig. 4 shows the step response obtained using (7), (8) and (9), which clearly indicates that the step response get delayed when filter order is increased. In-order to analyze the impact on operating time delay in numerical distance protection, analog antialiasing filters ((4), (5), (6)) are used in the developed relay model in SIMULINK for the test system which is discussed in next section.

#### IV. SYSTEM UNDER STUDY

A 400 KV SMIB system considered for the study, is shown in Fig.5 (Appendix A), where current transformer is modeled as an ideal transformer, but voltage signals delivered to the relay are fed from capacitive voltage transformer secondary. CVT data for developing the model in SIMULINK is from [9].

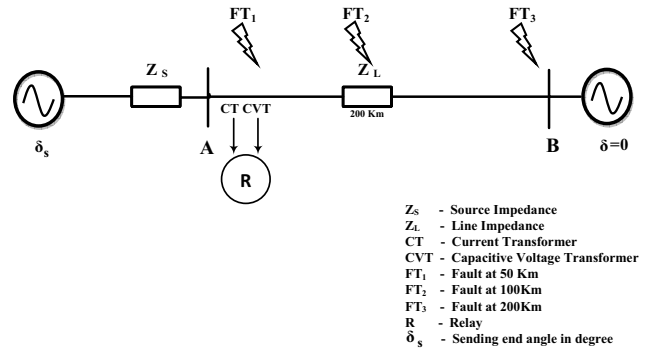

Fig. 5: Single line diagram of 400KV test system

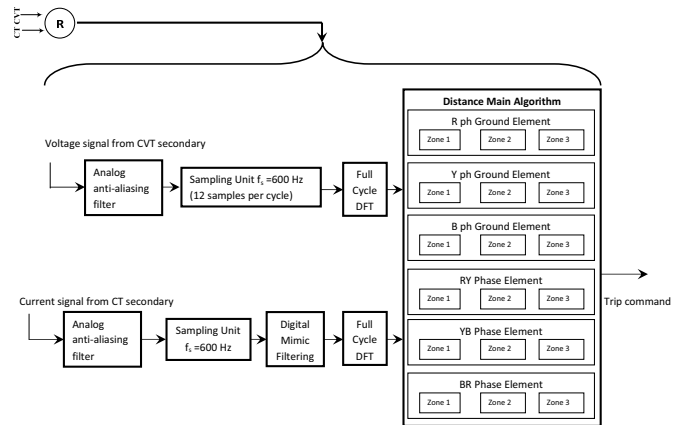

Fig. 6: Developed numerical distance relay model in SIMULINK

Fig.6 shows the numerical distance relay model which is developed in SIMULINK. The voltage and current signals are fed online to the main algorithm via analog antialiasing filter, sampling unit with sampling frequency  $f_s=600$  Hz which ensures Nyquist criteria  $f_s \geq 2f_c$ , where  $f_c=90$  Hz. Filtered voltage and current signals are then fed to full cycle discrete Fourier transform where the time domain information is taken to the frequency domain in the form of phasor, but the current signals are fed to the digital mimic filter (10) to eliminate dc offset [10], before they are feeded to full cycle discrete Fourier transform.

$$H(z) = 1.965 - 1.8864z^{-1} \quad (10)$$

where,  $H(z)$  is the transfer function of the digital mimic filter.

The voltage and current phasors (50 Hz) extracted from the full cycle discrete Fourier transform are then fed to the

distance main algorithm containing 3 ground (R ph, Y ph, B ph) and 3 phase elements (RY, YB, BR) for fault detection. Each element in distance main algorithm is modeled with traditional 3 zone mho characteristic without load encroachment, where Zone 1 is set to cover 80 % of line length without any intentional time delay. Intentional time delay for Zone 2 and Zone 3 are set as 200ms and 400ms respectively.

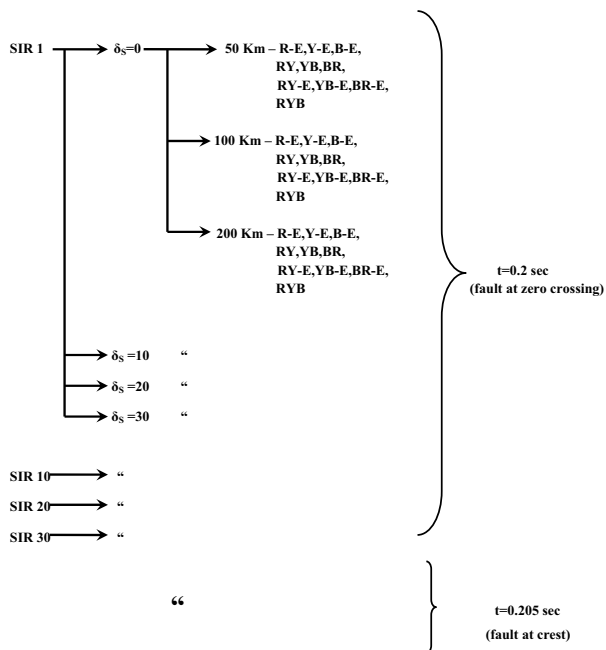

Fig. 7: Simulation cases carried out to investigate numerical distance relay performance

The transfer functions (4), (5) and (6) which were discussed in section II are used in this relay model to find the operating time delay and relay maloperation(selectivity) when filter order is changed. Selectivity is only concentrated in this study, even-though relay maloperation may be due to various other reasons. Relay maloperation(selectivity) in this study, relates to triggering of Zone 1, when a fault occurs at 100% of line length i.e. 200km. Different cases as shown in Fig.7 are simulated and the operating time and relay maloperation (selectivity) for these cases with 1<sup>st</sup>, 2<sup>nd</sup> and 3<sup>rd</sup> order filters are compared. Impact of using higher order filters with simulation results are discussed in next section.

## V. SIMULATION RESULTS

The simulation results for the cases which are listed in Fig.7 are split into two parts (as listed below) and are shown in two following subsections separately,

- internal fault (50Km, 100Km)
- external fault (200Km)

In all these cases  $F_1$ ,  $F_2$  and  $F_3$  are used to represent relay operating time/maloperation when analog antialiasing filter block in Fig.6 uses 1<sup>st</sup>, 2<sup>nd</sup> and 3<sup>rd</sup> order filters respectively. In addition to this  $F_1-F_2$ ,  $F_1-F_3$  and  $F_2-F_3$  are also used to represent the difference in operating time i.e. operating time with respective filters in relay model.

### A. Internal Fault

The results for this case are again split into two parts as indicated in Fig. 7,

- $t = 0.2$  sec (faults at zero crossing)
- $t = 0.205$  sec (faults at crest)

1) faults at zero crossing: Difference in operating time of 1<sup>st</sup> and 2<sup>nd</sup> ( $F_1-F_2$ ), 1<sup>st</sup> and 3<sup>rd</sup> ( $F_1 - F_3$ ), 2<sup>nd</sup> and 3<sup>rd</sup> ( $F_2-F_3$ ) order filters are computed for the cases listed in Fig. 7. Fig. 8 shows that, about 55% to 65% of the cases, there is no change in operating time and about 16% to 20% of cases are found to have reduced operating time which are unexpected as higher order filter will introduce delay. In order to analyze the cause for reduced operating time, the cases (16% - 20%) which have reduced operating time when filter order is increased are considered separately. Fig. 9 shows the comparison of difference in operating time for varying SIR for the cases which have reduced operating time (16% - 20%). It is found from Fig. 9 that, reduction in operating time occurs when SIR increases and there is no reduction in operating time when SIR = 1.

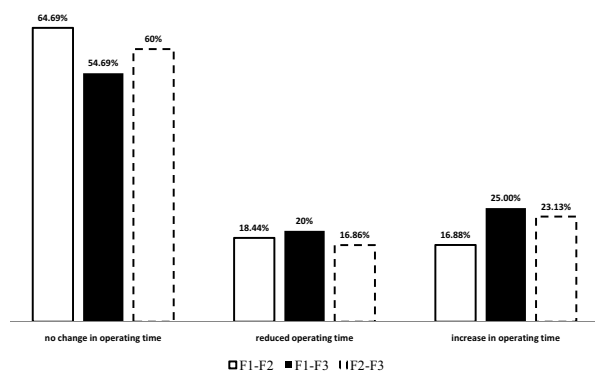

Fig. 8: Comparison of difference in operating time for faults at  $t = 0.2$ sec with 1<sup>st</sup>, 2<sup>nd</sup> and 3<sup>rd</sup> order filters in relay model

Fig. 8 also shows that, for about 17 % to 20 % of cases have increased operating time when higher order filters are used. It is also evident from Fig. 8 that, about 75 % of the cases the use of higher order filter has positive impact i.e. either there is no change in relay operating time or the relay operating time reduces and for the remaining about 25 % of cases have negative impact as expected i.e. increase in relay

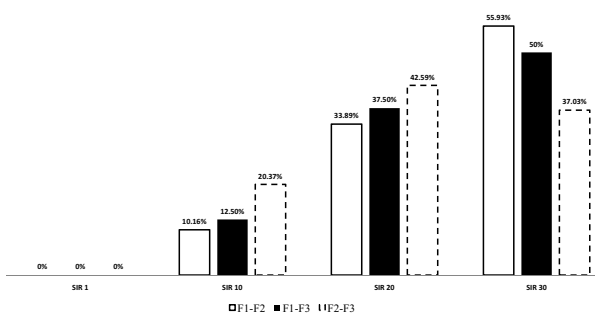

Fig. 9: Comparison of reduced operating time cases (16% - 20%) for varying SIR and for faults at  $t = 0.2$ sec

operating time. In order to analyze the impact on numerical distance relay operating time when higher order filters are used, the maximum reduction and maximum increase in operating time of  $(F_1-F_2)$ ,  $(F_1-F_3)$  and  $(F_2-F_3)$  are obtained from simulation results for the cases as listed in Fig. 7 for faults at  $t = 0.2$  sec. Table. III shows the maximum reduction (Appendix B for actual operating times) and maximum increase in relay operating time. Impedance loci for each of the maximum reduction case i.e. 175ms, 173.2ms and 30ms are shown in Fig. 10, Fig. 11 and Fig. 12 respectively.

TABLE III

Maximum reduction and maximum increase in operating time for faults at  $t = 0.2$  sec

Filter	Time in ms	
	Maximum Reduction	Maximum Increase
$F_1 - F_2$	175	6.6
$F_1 - F_3$	173.2	5
$F_2 - F_3$	30	3.4

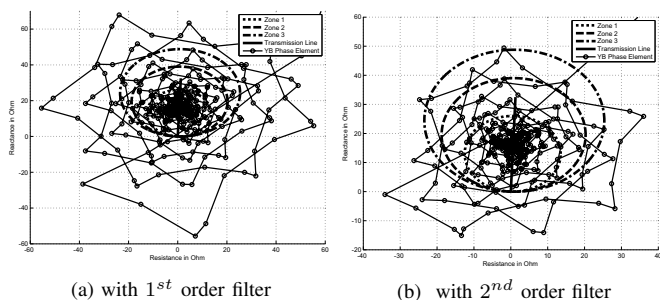

Fig. 10: Impedance loci with  $1^{st}$  and  $2^{nd}$  order filter for YB phase fault at  $t = 0.2$  sec and at 100 km ( $SIR = 30$ ,  $\delta_s = 30$ )

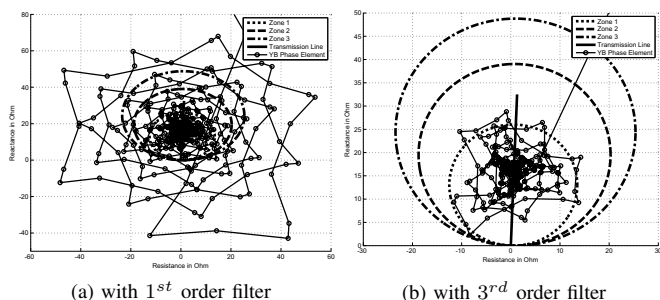

Fig. 11: Impedance loci with  $1^{st}$  and  $3^{rd}$  order filter for YB phase fault at  $t = 0.2$  sec and at 100 km ( $SIR = 30$ ,  $\delta_s = 0$ )

2) *Faults at crest:* In a similar fashion as already discussed in the previous subsection (fault at zero crossing), difference in operating time for faults at  $t = 0.205$  sec are obtained. Fig. 13 shows that about 50% to 60% of the cases, there is no change in operating time and about 13% to 28% of cases are found to have reduced operating time which is again unexpected as

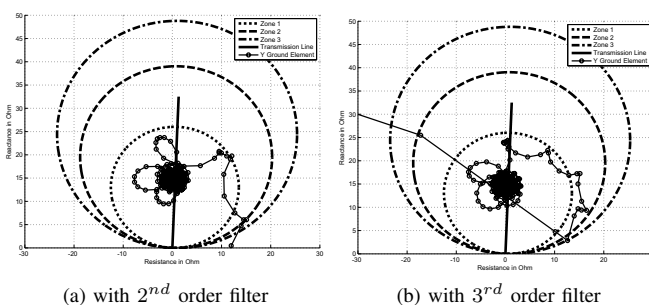

Fig. 12: Impedance loci with  $2^{nd}$  and  $3^{rd}$  order filter for Y phase to ground fault at  $t = 0.2$  sec and at 100 km ( $SIR = 30$ ,  $\delta_s = 0$ )

higher order filter will introduce delay. Fig. 14 is obtained by considering only the cases with reduced operating time. It is again found that, reduction in operating time occurs when  $SIR$  increases and there is no reduction in operating time when  $SIR = 1$ . Here again in Fig. 14, it is found that about 77 % of the simulated cases have positive impact and remaining cases have negative impact on relay operating time.

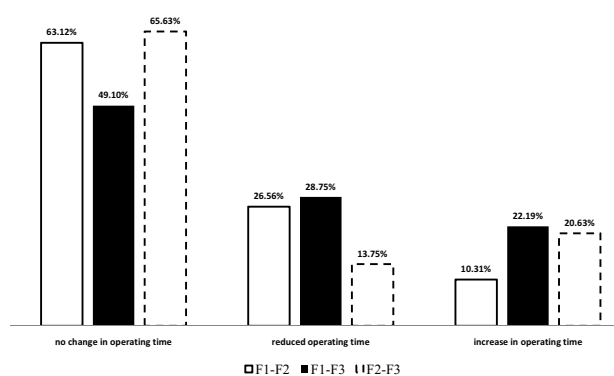

Fig. 13: Comparison of difference in operating time for faults at  $t = 0.205$  sec with  $1^{st}$ ,  $2^{nd}$  and  $3^{rd}$  order filters in relay model

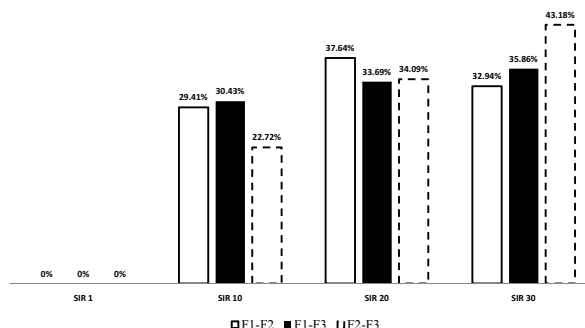

Fig. 14: Comparison of reduced operating time cases (13% - 28%) for varying  $SIR$  and for faults at  $t = 0.205$ sec

In order to analyze the impact on relay operating time when higher order filters are used and for change in fault time i.e. at crest, the maximum reduction and maximum

increase in operating time of  $(F_1-F_2)$ ,  $(F_1-F_3)$  and  $(F_2-F_3)$  are obtained from simulation results for the cases as listed in Fig. 7 for faults at  $t = 0.205$  sec. Table. IV shows that, maximum reduction (Appendix B for actual operating times) and maximum increase in relay operating time. Impedance loci for these cases are shown in Fig. 15, Fig. 16 and Fig. 17.

TABLE IV: Maximum reduction and maximum increase in operating time for faults at  $t = 0.205$  sec

Filter	Time in ms	
	Maximum Reduction	Maximum Increase
$F_1 - F_2$	141	6.8
$F_1 - F_3$	140	3.4
$F_2 - F_3$	40	5

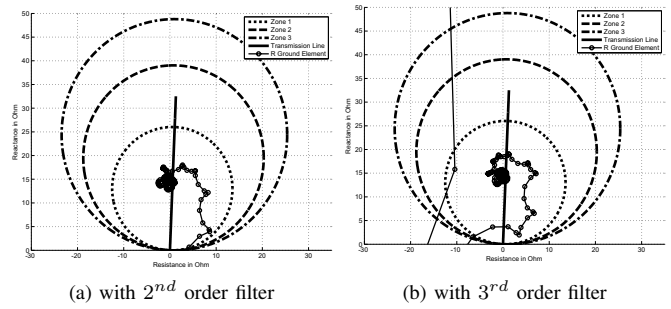

Fig. 17: Impedance loci with 2<sup>nd</sup> and 3<sup>rd</sup> order filter for R phase to ground fault at  $t = 0.205$  sec and at 100 km ( $SIR = 30$ ,  $\delta_s = 30$ )

TABLE V: Relay maloperation for faults at 200km line length

Filter	Maloperation in %	
	$t = 0.2sec$	$t = 0.205sec$
1 <sup>st</sup>	71.25	76.25
2 <sup>nd</sup>	68.75	70.625
3 <sup>rd</sup>	67.5	68.125

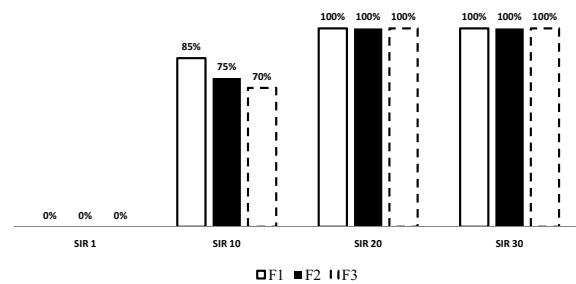

Fig. 18: Relay maloperation for faults at  $t = 0.2$  sec and for different SIR

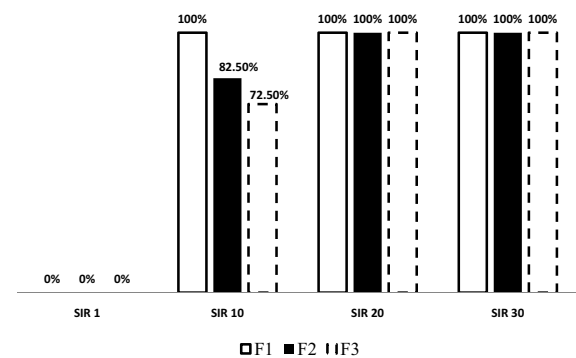

Fig. 19: Relay maloperation for faults at  $t = 0.205$  sec and for different SIR

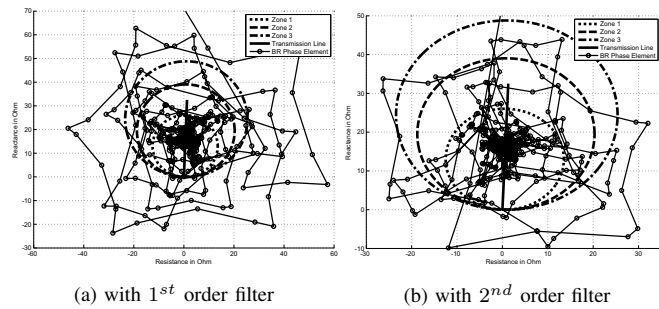

Fig. 15: Impedance loci with 1<sup>st</sup> and 2<sup>nd</sup> order filter for BR phase fault at  $t = 0.205$  sec and at 100 km ( $SIR = 30$ ,  $\delta_s = 30$ )

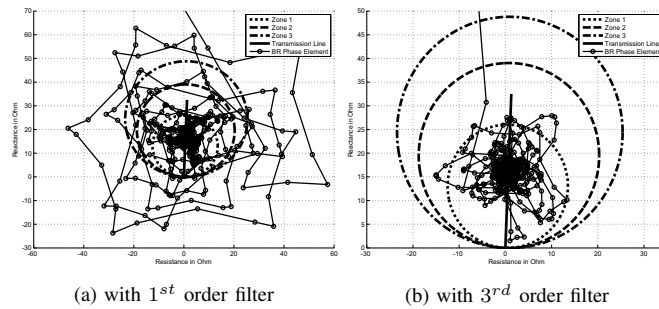

Fig. 16: Impedance loci with 1<sup>st</sup> and 3<sup>rd</sup> order filter for BR phase fault at  $t = 0.205$  sec and at 100 km ( $SIR = 30$ ,  $\delta_s = 30$ )

### B. External fault

The values listed in Table. V are obtained by considering 10 different kinds of faults at 200km line length for different different SIR and loading conditions. The impact of using higher order filters on relay maloperation for fault at  $t = 0.2$  sec and  $t = 0.205$  sec are shown in Fig. 18 and Fig. 19 respectively.

### VI. OBSERVATIONS AND INFERENCES

It is observed from the above simulation results that,

- 1) The high frequency transients in voltage signal which occur during high SIR conditions, causes the impedance trajectory to encircle the mho characteristic and fault

point [6] as expected,

- 2) Use of 1<sup>st</sup> order filter results in encirclements with large radii from the fault location before it spirals down to the final fault location point,
- 3) Use of 2<sup>nd</sup> or 3<sup>rd</sup> order filter results in encirclements with relatively small radii from the fault location before it spirals down to the final fault location point,
- 4) Reduction in relay operating time was much higher when compared to increase in relay operating time,
- 5) It is also found that about 75% of the simulated cases there is no increase in operating time even-though there is a time delay.
- 6) Relay maloperation reduces when higher order filters are used, but it is found that it has less impact during high SIR conditions.

It is inferred from the observations that,

- 1) Reduced attenuation of high frequency signals occurs when 1<sup>st</sup> order filter is used since there is no sharp transition from pass band to stop band,
- 2) Attenuation of high frequency signal magnitude is relatively more when 2<sup>nd</sup> and 3<sup>rd</sup> order filters are used since the transition between pass band and stop band is relatively sharp causing the high frequency voltage magnitude to attenuate. Since the impedance is directly proportional to voltage, this also cause reduction in oscillation of estimated impedance magnitude, causing the impedance trajectory to enter the mho characteristics faster than the lower order filter.

## VII. CONCLUSION

Investigation of using higher order filters in numerical distance relay reveals that, the increase in operating time will not be similar to the time delay obtained at fundamental frequency from phase response. Operating time delay and relay maloperation for higher order filters depends upon the system conditions, in particular SIR conditions. Since relay operating time and maloperation are some of the important factors which should be taken into account during relay design, from the investigation it is clear that, numerical distance relay with higher order filters provide better performance for most of the cases. Even-though this paper investigates the use of higher order filter the optimal selection of filter order requires extensive simulation studies.

## APPENDIX A

TABLE VI

TRANSMISSION LINE PARAMETERS

line parameters	Resistance ( $\Omega$ )	Reactance ( $\Omega$ )
positive sequence	2.3363	59.1181
negative sequence	2.3363	59.1181
zero sequence	54.2576	184.6135

where,

## APPENDIX B

$O_1$  : 1<sup>st</sup> order filter       $O_2$  : 2<sup>nd</sup> order filter  
 $O_3$  : 3<sup>rd</sup> order filter

TABLE VII  
 MAXIMUM REDUCTION CASE (TABLE III)

SIR	sending end angle ( $\delta_s$ )	fault type	phase	location (%)	Time in ms		
					$O_1$	$O_2$	$O_3$
30	30	L-L	YB	50	198.2	23.2	25
30	0	L-L	YB	50	198.2	23.2	25
30	0	SLG	Y	50	71.6	53.2	23.2

TABLE VIII  
 MAXIMUM REDUCTION CASE (TABLE IV)

SIR	sending end angle ( $\delta_s$ )	fault type	phase	location (%)	Time in ms		
					$O_1$	$O_2$	$O_3$
30	30	L-L	BR	50	165	23.2	25
30	30	L-L	BR	50	165	23.2	25
30	30	SLG	R	50	81.6	63.2	23.2

## REFERENCES

- [1] Brigham. E. Oran, *The Fast Fourier Transform*. Englewood Cliffs, NJ: Prentice-Hall, 1974.
- [2] M. Adamiak et al., "Advancements in adaptive algorithms for secure high speed distance protection," in *23<sup>rd</sup> Annual Western Protective Relaying Conference*, 1996.
- [3] D. Hou, "Relay element performance during power system frequency excursions," in *61<sup>st</sup> Annual Conference for Protective Relay Engineers*, pp. 105 –117, Apr. 2008.
- [4] S. G. A. Perez, "Modelling Relays for Power System Protection Studies," Ph.D. dissertation, Dept. Elect. Engg., Saschkatchewan Univ., Canada, 2006.
- [5] A. Sweetana, "Transient response characteristics of capacitive potential devices," *IEEE Transactions on Power Apparatus and Systems*, vol. PAS-90, pp. 1989–2001, Sep 1971.
- [6] B. Kasztenny et al., "Distance relays and capacitive voltage transformers balancing speed and transient overreach," in *53<sup>rd</sup> Annu. Conf. for Protective Relay Engineering, Ontario, Canada, Apr. 2000*.
- [7] A. G. Phadke and J. S. Thorp. John Wiley & Sons, Ltd, Jul 2009.
- [8] S. M. Brahma, P. L. De Leon, and R. G. Kavasseri, "Investigating the option of removing the antialiasing filter from digital relays," *IEEE Trans. Power Del.*, vol. 24, pp. 1864–1868, Oct 2009.
- [9] J. Izykowski, B. Kasztenny, E. Rosolowski, M. Saha, and B. Hillstrom, "Dynamic compensation of capacitive voltage transformers," *IEEE Trans. Power Del.*, vol. 13, no. 1, pp. 116–122, Jan. 1998.
- [10] G. Benmouyal, "Removal of dc-offset in current waveforms using digital mimic filtering," *IEEE Trans. Power Del.*, vol. 10, no. 2, pp. 621–630, Apr. 1995.