

Optimal Choice and Location of Multi Type Facts Devices in Deregulated Electricity Market Using Evolutionary Programming Method

K. Balamurugan, R. Muralisachithanandam, V. Dharmalingam, R. Srikanth

Abstract—This paper deals with the optimal choice and allocation of multi FACTS devices in Deregulated power system using Evolutionary Programming method. The objective is to achieve the power system economic generation allocation and dispatch in deregulated electricity market. Using the proposed method, the locations of the FACTS devices, their types and ratings are optimized simultaneously. Different kinds of FACTS devices are simulated in this study such as UPFC, TCSC, TCPST, and SVC. Simulation results validate the capability of this new approach in minimizing the overall system cost function, which includes the investment costs of the FACTS devices and the bid offers of the market participants. The proposed algorithm is an effective and practical method for the choice and allocation of FACTS devices in deregulated electricity market environment. The standard data of IEEE 14 Bus systems has been taken into account and simulated with aid of MAT-lab software and results were obtained.

Keywords—FACTS devices, Optimal allocation, Deregulated electricity market, Evolutionary programming, Mat Lab.

I. INTRODUCTION

HISTORICALLY, the electricity industry was a monopoly industry with a vertical structure. In a vertically integrated environment, enterprises were responsible for the generation, transmission and distribution of electrical power in a given geographical area. Such companies could be state owned as well as private. But the last three decades, and especially during the 1990s, the electricity supply service has been undergoing a drastic reform all over the world. The old monopolist power markets are replaced with deregulated electricity markets open to the competition. Different forces have driven the power market towards the deregulation [1]. Even though the idea of deregulation is good, but not all of the electric system is suitable for such a change. Distribution and transmission are natural monopolies that invalidate them as participants in an open competitive market. This leaves generation as the only sector suitable for a competitive market.

Mr. K. Balamurugan is with the Department of Electrical and Electronics Engineering, SASTRA University, Thanjavur, Tamilnadu, India (e-mail: kbm@eee.sastra.edu).

Dr. R. Muralisachithanandam is with the D Department of Electrical and Electronics Engineering, SASTRA University, Thanjavur, Tamilnadu, India (e-mail: zenmurali@gmail.com).

Dr. V. Dharmalingam is with the M.A.M school of Engineering, Tiruchirappalli, Tamilnadu, India (e-mail: dharmalingamv@yahoo.co.in).

Dr. R. Srikanth is with the Department of Mathematics, SASTRA University, Thanjavur, and Tamilnadu, India (e-mail: srikanth@maths.sastra.edu).

But this does not mean that distribution and transmission would be untouched. Competition can be established in generation, but only if the necessary changes are introduced in distribution and transmission to allow and encourage a competitive generation market.

II. FACTS

With ever increasing demand of electric power, the existing transmission networks even in the developed countries are found to be weak which results in poor quality of unreliable supply. Also, it is seen that in order to expand or enhance the power transfer capability of the existing transmission network huge sum of finances aid required and sometimes even difficulties are encountered in finding right-of-way for the new lines. Lot of research has gone into developing new technologies over the past few years to gain increased efficiency from the existing power system. This program is known as flexible A.C transmission system abbreviated as FACTS. The new technologies employ high speed thyristors for switching in or out transmission line components such as capacitors, reactors or phase shifting transformer for some desirable performance of the systems.

The main objective of FACTS devices is to replace the existing slow acting mechanical controls required to react to the changing system conditions by rather fast acting electronic controls. Alternating current transmission systems incorporating power-electronic based and other static controllers to enhance controllability and increase power transfer capability. The FACTS technology is not a single high-power Controller, but rather a collection of Controllers, which can be applied individually or in coordination with others to control one or more of the interrelated system parameters mentioned above.

A. Functional Diagram of the FACTS Devices

1. Thyristors Controlled Series Compensator (TCSC)

By modifying the reactance of the transmission line, the TCSC acts as the capacitive or inductive compensation respectively. In this study, the reactance of the transmission line is adjusted by TCSC directly. The rating of TCSC is depending on the reactance of the transmission line where the TCSC is located [2], [3].

$$X_{ij} = X_{Line} + X_{TCSC} \quad (1)$$

$$X_{TCSC} = r_{TCSC} X_{Line} \quad (2)$$

where X_{Line} is the reactance of the transmission line and r_{TCSC} is the coefficient which represents the degree of compensation by TCSC. To avoid overcompensation, the working range of the TCSC is chosen between $-0.7X_{Line}$ and $0.2X_{Line}$.

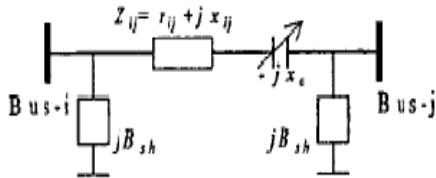

Fig. 1 Model of TCSC

The model of a transmission line with a TCSC connected between bus-i and bus-j is shown in Fig. 1. During the steady state the TCSC can be considered as a static reactance $-jX_c$. The real power injections at bus-i (P_{ic}) and bus-j (P_{jc}) can be expressed as follows.

$$P_{ic} = V_i^2 \Delta G_{ij} - V_i V_j [\Delta G_{ij} \cos \delta_{ij} + \Delta B_{ij} \sin \delta_{ij}] \quad (3)$$

$$P_{jc} = V_j^2 \Delta G_{ij} - V_i V_j [\Delta G_{ij} \cos \delta_{ij} - \Delta B_{ij} \sin \delta_{ij}] \quad (4)$$

Similarly, the reactive power injections at bus-i (Q_{ic}) and bus-j (Q_{jc}) can be expressed as

$$Q_{ic} = -V_i^2 \Delta B_{ij} - V_i V_j [\Delta G_{ij} \sin \delta_{ij} - \Delta B_{ij} \cos \delta_{ij}] \quad (5)$$

$$Q_{jc} = -V_j^2 \Delta B_{ij} + V_i V_j [\Delta G_{ij} \sin \delta_{ij} + \Delta B_{ij} \cos \delta_{ij}] \quad (6)$$

$$\Delta G_{ij} = \frac{x_c r_{ij} (x_c - 2x_{ij})}{(r_{ij}^2 + x_{ij}^2)(r_{ij}^2 + (x_{ij} - x_c)^2)} \quad (7)$$

$$\Delta B_{ij} = \frac{-x_c (r_{ij}^2 - x_{ij}^2 + x_c x_{ij})}{(r_{ij}^2 + x_{ij}^2)(r_{ij}^2 + (x_{ij} - x_c)^2)} \quad (8)$$

2. Thyristor Controlled Phase Shifting Transformer (TCPST)

The voltage angle between the sending and receiving end of the transmission line can be regulated by TCPST. It is modeled as a series compensation voltage $U_{FACTS} = U_{TCPST}$, which is perpendicular to the bus voltage. The working range of the TCPST is between -5 degrees to $+5$ degrees. The injected currents at bus i and bus j can be expressed as follows.

$$\Delta I_{is} = \frac{\Delta U_{TCPST}}{Z_{ij}} \quad (9)$$

$$\Delta I_{js} = -\frac{\Delta U_{TCPST}}{Z_{ij}} \quad (10)$$

The equivalent circuit of TCPST is shown in Fig. 2. The injected active power at bus-i (P_{is}) and bus-j (P_{js}) and reactive

powers (Q_{is} and Q_{js}) of a line having a phase shifter are [2], [3].

$$P_{is} = -V_i^2 K^2 G_{ij} - V_i V_j S [G_{ij} \sin \delta_{ij} - B_{ij} \cos \delta_{ij}] \quad (11)$$

$$P_{js} = -V_i V_j K [G_{ij} \sin \delta_{ij} + B_{ij} \cos \delta_{ij}] \quad (12)$$

$$Q_{is} = -V_i^2 K^2 B_{ij} + V_i V_j S [G_{ij} \cos \delta_{ij} + B_{ij} \sin \delta_{ij}] \quad (13)$$

$$Q_{js} = -V_i V_j K [G_{ij} \cos \delta_{ij} - B_{ij} \sin \delta_{ij}] \quad (14)$$

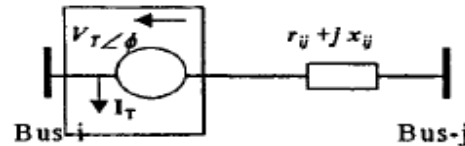

Fig. 2 Equivalent circuit for TCPST

3. Unified Power Flow Controller (UPFC)

Basically, the UPFC has two voltage source inverters (VSI) sharing a common dc storage capacitor. It is connected to the system through two coupling transformers. In this study, the series compensation $U_{FACTS} = U_{UPFC}$ is employed.

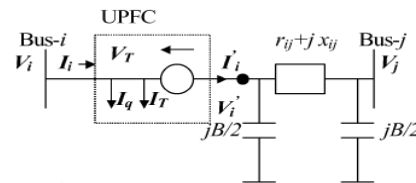

Fig. 3 Equivalent circuit of UPFC

The schematic representation of the UPFC is shown in Fig. 3. It consists of two voltage source converters and a dc circuit represented by the capacitor. Converter 1 is primarily used to provide the real power demand of converter 2 at the common dc link terminal from the ac power system. Converter 1 can also generate or absorb reactive power at its ac terminal, which is independent of the active power transfer to (or from) the dc terminal. Converter 2 is used to generate a voltage source at the fundamental frequency with variable amplitude ($0 \leq V_t \leq V_{tmax}$) and phase angle ($0 \leq \theta_t \leq 2\pi$), which is added to the ac transmission line by the series-connected boosting transformer. The inverter output voltage injected in series with line can be used for direct voltage control, series compensation, phase shifter, and their combinations. UPFC has three controllable parameters, namely, the magnitude and the angle of inserted voltage (V_t, θ_t) and the magnitude of the current (I_Q). The injected active power at bus-i (P_{is}) and bus-j (P_{js}) and reactive powers (Q_{is} and Q_{js}) of a line having a UPFC are [4].

$$P_{is} = V_i^2 g_{ij} - 2V_i V_T g_{ij} \cos(\theta_T - \delta_i) + V_j V_T [g_{ij} \cos(\theta_T - \delta_i) + b_{ij} \sin(\theta_T - \delta_i)] \quad (15)$$

$$P_{js} = V_j V_T [g_{ij} \cos(\theta_T - \delta_i) - b_{ij} \sin(\theta_T - \delta_i)] \quad (16)$$

$$Q_{is} = V_i I_q + V_i V_T [g_{ij} \sin(\theta_T - \delta_i) + (b_{ij} + \frac{B}{2}) \cos(\theta_T - \delta_i)] \quad (17)$$

$$Q_{js} = -V_j V_T [g_{ij} \sin(\theta_T - \delta_i) + b_{ij} \cos(\theta_T - \delta_i)] \quad (18)$$

4. Static Var Compensator (SVC)

The SVC can be operated as both inductive and capacitive compensation. It is modeled as an ideal reactive power injection at bus i.

$$\Delta Q_{is} = Q_{SVC} \quad (19)$$

The primary purpose of SVC is usually control of voltages at weak points in a network. This may be installed at midpoint of the transmission line. The reactive power output of an SVC can be expressed as follows [5].

$$Q_{SVC} = \frac{V_i(V_i - V_r)}{X_{s1}} \quad (20)$$

where X_{s1} is the equivalent slope reactance in p.u. and V_r are reference voltage magnitude.

III. MATHEMATICAL FORMULATION

A. Electricity Pool Market

The main characteristic of electricity pool market is that the power is traded through the market and not bilaterally between producers and consumers. The market is operated either by a separate *Pool Operator* or directly by the *Independent System Operator* (ISO). The task of market operator is to lead the pool market to a short-run economic optimum. In order to achieve this aim, the market operator collects the electric power bids from suppliers as well as from consumers. These bids are related to a certain time interval. When the bids are submitted, the market operator runs the OPF program taking into consideration the network constraints. The objective of this OPF program is to minimize the total costs, which is equivalent to maximizing the social welfare. In the monopoly power markets the utility was performing an OPF knowing the real cost data of its generators. Furthermore, the load was also given and had to be fully covered. Consequently, the market operator runs the OPF based on the bids collected from the market participants. The formula for the generation cost is as follows [6], [7].

$$C_2(P_G) = \frac{1}{2} \alpha_1 P^2 + \alpha_2 P + \alpha_3 \quad (21)$$

B. FACTS Devices Cost Function

The cost functions for SVC, TCSC and UPFC are developed as follows.

$$C_{1UPFC} = 0.0003S^2 - 0.269S + 188.22 \frac{\text{US\$}}{\text{kVar}} \quad (22)$$

$$C_{1TCSC} = 0.0015S^2 - 0.7130S + 153.75 \frac{\text{US\$}}{\text{kVar}} \quad (23)$$

$$C_{1SVC} = 0.0003S^2 - 0.3051S + 127.38 \frac{\text{US\$}}{\text{kVar}} \quad (24)$$

where 'S' is the operating range of the FACTS devices in MVar. The cost of a TCPST is more related to the operating voltage and the current rating of the circuit concerned [8]. Thus, once the TCPST is installed, the cost is fixed and the cost function can be expressed as follows.

$$C_{1TCPST} = d \cdot P_{\max} + IC \quad \text{US\$} \quad (25)$$

where 'd' is a positive constant representing the capital cost and 'IC' is the installation costs of the TCPST. P_{\max} is the thermal limit of the transmission line.

C. Optimal Choice and Location of FACTS

This project is proposed to determine the suitable location and rating of FACTS devices in deregulated electricity market. The overall system cost function which includes the bid offers of market participants and the investment cost of FACTS devices is employed. The formulation of the optimal location of FACTS devices can be expressed as follows [9], [10].

$$C_{\text{TOTAL}} = C_1(f) + C_2(P_G) \quad (26)$$

$$E(f, g) = 0 \quad (27)$$

$$B_1(f) < b_1, B_2(g) < b_2 \quad (28)$$

where $C_1(f)$ is the average investment costs of FACTS devices, $C_2(P_G)$ is the total generation costs, C_{TOTAL} is the overall cost of objective function, $E(f, g)$ is the equality constraints with respect to active and reactive power flow, $B_1(f)$ is the inequality constrains for FACTS devices, $B_2(g)$ is the inequality constrains for conventional power flow, 'f' is the variables of FACTS devices, 'P_G' is the generation power of the generators, 'g' is the operating state of the power system.

Normally, the FACTS devices will be in-service for many years. However, only a part of its lifetime is employed to regulate the power flow. In this paper, five years is applied to evaluate the cost function. Therefore the average value of the investment costs is calculated using the following equation:

$$C_1(f) = \frac{C^*(f)}{8760 \times 5} \frac{\text{US\$}}{\text{hour}} \quad (29)$$

where $C^*(f)$ is the total investment costs of FACTS devices.

D. Power Loss Formula

The exact loss formula of a system having N number of buses is [4], [6].

$$P_{\text{lt}}^C = \sum_{j=1}^N \sum_{k=1}^N [\alpha_{jk}(P_j P_k + Q_j Q_k) + \beta_{jk}(Q_j P_k - Q_k)] \quad (30)$$

$$\alpha_{jk} = \frac{R_{jk}}{V_j V_k} \cos(\delta_j - \delta_k) \quad (31)$$

$$\beta_{jk} = \frac{R_{jk}}{v_j v_k} \sin(\delta_j - \delta_k) \quad (32)$$

IV. EVOLUTIONARY PROGRAMMING

Evolutionary Programming (EP) is a powerful and general optimization method. The EP technique is based on the mechanics of natural selections. The main stages of the EP technique include initialization, mutation and selection. EP seeks the optimal solution of an optimization problem by evolving a population of candidate solutions over a number of generations or iterations. A new population is formed from an existing population through the use of a mutation operator. The degree of optimality of each of the new candidate solutions or individuals is measured by its fitness which can be defined as a function of the cost or objective function of the problem. Through the use of a selection scheme, the individuals in each population compete with each other. The winning individuals will form a resultant population which is regarded as the next generation. Through this the population evolves towards the global optimal point. The main components are presented as below [11], [12].

A. Initialization

The initial population is initialized randomly using sets of uniform random number distribution ranging over the feasible limits of each control variable in equation.

$$x_i = x_i^{\min} + u(x_i^{\max} - x_i^{\min}) \quad (33)$$

where x_i is the i^{th} element of the individual in a population $\min x_i$ and $\max x_i$ are the lower and upper limits of the i^{th} element of the individual. u is a uniform random number in the interval $[0, 1]$.

B. Fitness Function

The fitness of the k^{th} individual can be calculated by

$$f_k = K_f * F' \quad (34)$$

where f_k is the fitness of the k^{th} individual. K_f is an arbitrary constant, and F' is the objective function.

C. Mutation

A new population is generated by using the Gaussian mutation operator. Each element of the k^{th} new trial solution vector, V_k' , is computed by.

$$x'_{k,i} = x_{k,i} + N(0, \sigma_{k,i}^2) \quad (35)$$

$$\sigma_{k,i} = (x_i^{\max} - x_i^{\min}) \left[\frac{f_{\max} - f_k}{f_{\max}} + a^g \right] \quad (36)$$

where $x'_{k,i}$ is the value of the i^{th} element of the k^{th} offspring individual. $x_{k,i}$ is the value of the i^{th} element of the k^{th} parent individual. $N(0, \sigma_{k,i}^2)$ is a Gaussian random number with a mean of zero and standard deviation of k, i . x_i^{\min} and x_i^{\max} are the lower and upper limits of the i^{th} element of the k^{th} parent

individual. f_k is the fitness value of the k^{th} individual. f_{\max} is the maximum fitness of the parent population. The ' a ' is a positive number constant slightly less than one and ' g ' is the iteration counter.

D. Selection

The selection technique utilized is a tournament scheme, which can be expressed as;

$$w_t = \begin{cases} 1 & \text{if } f_k > f_r \\ 0 & \text{otherwise} \end{cases} \quad S_k = \sum_{t=1}^{N_t} w_t \quad (37)$$

where f_k is the fitness of the k^{th} individual in the combined population. f_r is the fitness of the r^{th} opponent randomly selected from the combined population based on $r = [2 * P * u + 1]$ is the greatest integer less than or equal to x . the ' u ' is a uniform random number in the interval $[0, 1]$ and P is the population size.

E. Termination Criterion

If the maximum generation number is reached, the iteration process is terminated. Otherwise, the mutation and selection process will be reiterated until the criterion is satisfied.

V. CASE STUDY

To check the effectiveness of the above said method, IEEE 14 bus system is shown in Fig. 4 is used for simulation. The system consist of 5 generators connected at the bus 1,2,3,6 & 8, these bus are called as the generator bus & are owned by the generating companies. Generator costs coefficients and Line data for IEEE 14 Bus system are given in Tables I and II. Loads are assumed to maintain constant power demand.

TABLE I
 GENERATOR COEFFICIENTS

Coefficients	G ₁	G ₂	G ₃	G ₄	G ₅
α_1	0.06	0.05	1	0.02	0.03
α_2	60	50	300	15	45
α_3	100	100	100	100	100

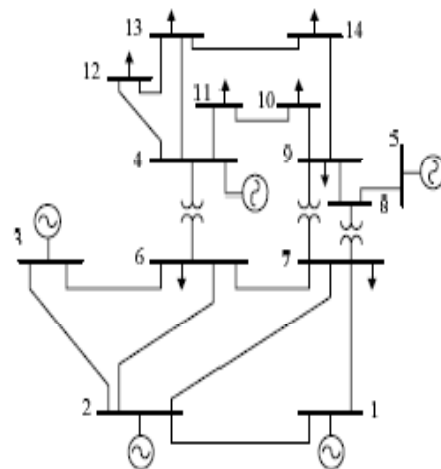

Fig. 4 Single line diagram for IEEE 14 Bus system

TABLE II
 LINE DATA FOR IEEE 14 BUS SYSTEMS

From bus	To bus	Resistance (p.u)	Reactance (p.u)
1	2	0.01938	0.05917
1	5	0.05403	0.22304
2	3	0.04699	0.19797
2	4	0.05811	0.17632
2	5	0.05695	0.17388
3	4	0.06701	0.17103
4	5	0.01335	0.04211
4	7	0.00	0.20912
4	9	0.00	0.55618
5	6	0.00	0.25202
6	11	0.09498	0.1989
6	12	0.12291	0.25581
6	13	0.06615	0.13027
7	8	0.00	0.17615
7	9	0.00	0.11001
9	10	0.03181	0.08450
9	14	0.12711	0.27038
10	11	0.08205	0.19207
12	13	0.22092	0.19988
13	14	0.17093	0.34802

A. Case 1 (Without FACTS)

In this case, the simulation was done without connecting the FACTS devices. The performance of the system is given in Table III.

TABLE III
 OUTPUT WITHOUT FACTS

Description	Without FACTS Device
Generation (MW)	G1 51.3991
	G2 88.9383
	G3 50.0011
	G4 149.7882
	G5 84.6439
Power Flow	68.1668
Power Loss (MW)	24.7436
Cost (US\$/MW-hr)	30792

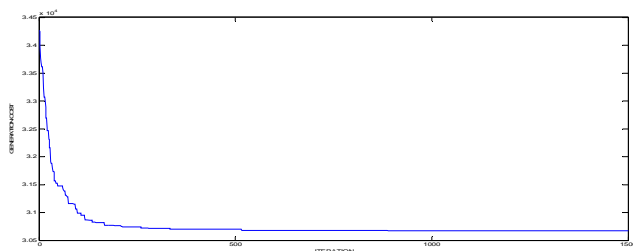

Fig. 5 Iteration Vs Cost Curve

B. Case 2 (With TCSC)

In this case the TCSC is placed in line 1-5 in reference to case 1 and program is simulated. Optimal power flow, injected active power to the bus and losses of the system with TCSC is found. The obtained result from MATLAB coding is given in Table IV.

TABLE IV
 OUTPUT WITH TCSC

Description	Without FACTS Device	With TCSC
Generation (MW)	G1 51.3991	50.5615
	G2 88.9383	80.3642
	G3 50.0011	50.0315
	G4 149.7882	149.0860
	G5 84.6439	93.0472
Power Flow	68.1668	84.0337
Power Loss (MW)	24.7436	20.3967
Cost (US\$/MW-hr)	30792	30783

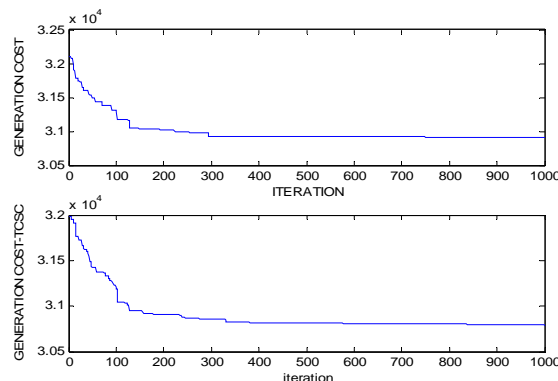

Fig. 6 Iteration Vs Cost Curve

C. Case 3 (With TCPST)

In this case the TCPST is placed in line 1-5 in reference to case 1 and program is simulated. Optimal power flow, injected active power to the bus and losses of the system with TCPST is found. The obtained result from MATLAB coding is given in Table V.

TABLE V
 OUTPUT WITH TCPST

Description	Without FACTS Device	With TCPST
Generation (MW)	G1 51.3991	50.6912
	G2 88.9383	50.3327
	G3 50.0011	50.0073
	G4 149.7882	149.8595
	G5 84.6439	120.0045
Power Flow	68.1668	97.6683
Power Loss (MW)	24.7436	20.8733
Cost (US\$/MW-hr)	30792	30468

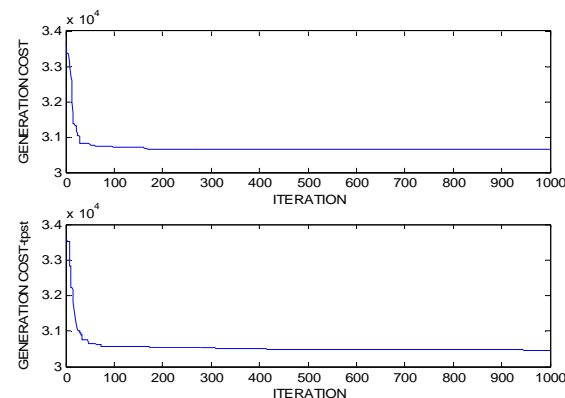

Fig. 7 Iteration Vs Cost Curve

D. Case 4 (With SVC)

In this case the SVC is placed in line 1-5 in reference to case 1 and program is simulated. Optimal power flow, injected active power to the bus and losses of the system with SVC is found. The obtained result from MATLAB coding is given Table VI.

TABLE VI
OUTPUT WITH SVC

Description	Without FACTS Device	With SVC
Generation (MW)	G1	51.3991
	G2	88.9383
	G3	50.0011
	G4	149.7882
	G5	84.6439
Power Flow	68.1668	84.0337
Power Loss (MW)	24.7436	20.3967
Cost (US\$/MW-hr)	30792	30518

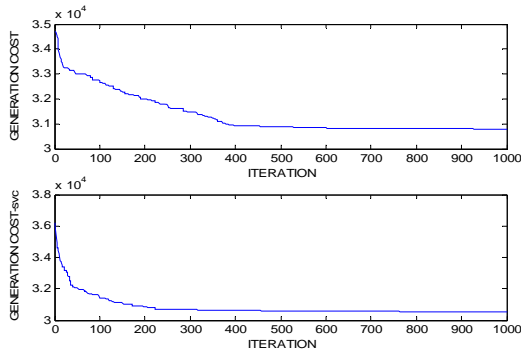

Fig. 8 Iteration Vs Cost Curve

E. Case 5 (With UPFC)

In this case the UPFC is placed in line 1-5 in reference to case 1 and program is simulated. Optimal power flow, injected active power to the bus and losses of the system with UPFC is found. The obtained result from MATLAB coding is given in Table VII

TABLE VII
OUTPUT WITH UPFC

Description	Without FACTS Device	With UPFC
Generation (MW)	G1	51.3991
	G2	88.9383
	G3	50.0011
	G4	149.7882
	G5	84.6439
Power Flow	68.1668	83.6892
Power Loss (MW)	24.7436	23.0645
Cost (US\$/MW-hr)	30792	30661

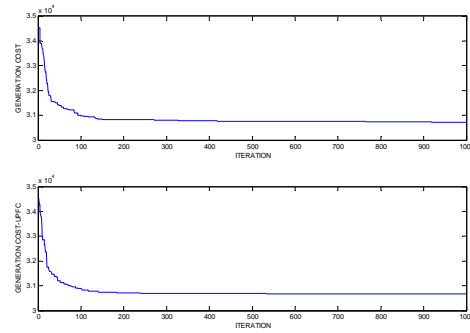

Fig. 9 Iteration Vs Cost Curve

F. Case 6 (With Multi FACTS)

In this case the TCSC in line 1-5, UPFC in line 2-4, TCPST in line 1-2, and SVC in line 2-3, and the IEEE 14 bus system data's are fed and program is simulated. Optimal power flow of the system with Multi FACTS devices are found out in Tables VIII and IX.

TABLE VIII
OUTPUT WITH MULTI FACTS DEVICES

Description	Without FACTS Device	With Multi FACTS
Generation (MW)	G1	51.1940
	G2	88.9383
	G3	50.0011
	G4	149.9921
	G5	115.1823
Power Loss (MW)	24.7436	17.9348
Cost (US\$/MW-hr)	30792	30354

TABLE IX
POWER FLOW

Line	FACTS device	Power flow (MVA)	Power flow for without FACTS (MVA)
1-5	TCSC	81.2631	68.1668
2-4	UPFC	82.9027	78.7815
1-2	TCPST	92.2078	83.2612
2-3	SVC	93.7037	64.6572

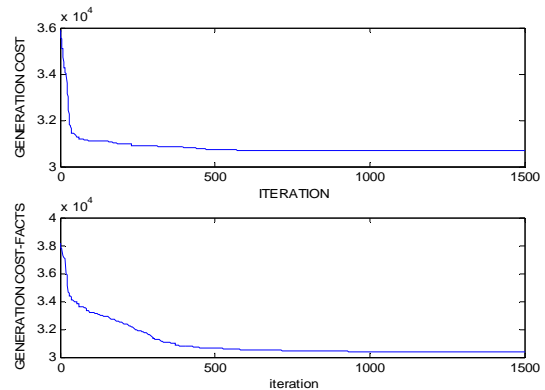

Fig. 10 Iteration Vs Cost Curve

VI. CONCLUSION

In this paper, an evolutionary programming based approach is proposed to determine optimal choice and location of

FACTS devices in the deregulated electricity market. Four types of FACTS devices such as TCSC, UPFC, TCPST and SVC were simulated. The overall system cost function, which includes the bid offers of the market participants and the investment costs of FACTS devices, is employed to evaluate the power system performance. Simulation results validate the efficiency of this new approach in minimizing the overall system cost function. It was found after simulation that the active power flow of the transmission line increased up to its thermal limits by connecting the FACTS devices in the line. The proposed algorithm is an effective and practical method for the location of FACTS devices in deregulated electricity market.

REFERENCES

- [1] L.J. Cai, I. Erlich and G. Stamtis, "Optimal choice and allocation of FACTS devices in deregulated electricity markets using genetic algorithms", *IEEE Power Engineering Society Power System Conference and Exposition*, vol. 1, pp 201-207, October 2004.
- [2] J. Baskaran, Dr. V. Palanisamy, "Genetic Algorithm applied to Optimal Location of FACTS devices in a power system network considering economic saving cost", *Academic open internet journal*, vol 15, 2005.
- [3] S. Gerbex, R. Cherkaoui, and A.J. Germond, "Optimal location of multi type FACTS devices in a power system by means of genetic algorithms", *IEEE Trans. Power system*, vol. 16, pp. 537-544, August 2001.
- [4] Mrs. S. Latha, Mrs. Raja Mary Slochanal & Mr. K. Balamurugan, "Optimum size and Location of UPFC Using the Method of Evolutionary Programming", *IE-Journal (EL)*, Vol-83, Dec-2002, Page No. 242 to 245.
- [5] T. S. Chung, and Y. Z. Li, "A hybrid GA approach for OPF with consideration of FACTS devices", *IEEE Power Engineering Review*, pp.47-57, February 2001
- [6] E. Handschin and C. Lehmkoetter, "Optimal Power Flow for Deregulated System with FACTS Devices", *Proc. 13th PSCC, Trondheim, Norway*, June-28-July-2, pp.1270-1276, 1999.
- [7] S.C. Srivastava and R.K. Verma, "Impact of FACTS devices on transmission pricing in a deregulated electricity market", *International Conference on Electric Utility Deregulation and Restructuring and Power Technologies*, pp 642- 648, 4-7 April 2000.
- [8] Lijun Cai and Istvan Erlich, "Optimal Choice and Allocation of FACTS Devices using Genetic Algorithms", *ISAP, Intelligent System Application to Power System, Lemnos, Greece*, August 31 – September 3, 2003.
- [9] G.C. Stamtis, "Power Transmission Cost Calculation in Deregulated Electricity Market", *Logos Verlag Berlin, ISBN 3-8325-0452-4*, Berlin, 2004.
- [10] E. J. de Oliveira, J. W. M. Lima, J. L. R. Pereira, "Flexible AC transmission devices: Allocation and transmission pricing", *Electrical Power and Energy System*, 21, pp. 111-118, 1999.
- [11] Mrs. G. Suganya, Mr. K. Balamurugan, Dr. V. Dharmalingam, "Multi-objective Evolutionary Programming Technique for Economic / Emission Load Dispatch", *IEEE-International Conference on Advances in Engineering, Science and Management, ICAESM-2012*, Article number-6216128, Pages 269-275, 30, 31 March 2012.
- [12] W. L. Fang, and H. W. Ngan, "Optimising location of unified power flow controllers using the method of augmented Lagrange multipliers", *IEE Proc.-Gener. Transm. Distrib.*, vol. 146, pp. 428-434, September 1999.