

Experimental Investigation of Adjacent Hall Structures Parameters

Ivelina N. Cholakova, Tihomir B. Takov, Radostin Ts. Tsankov, Nicolas Simonne, and Slavka S. Tzanova

Abstract—Adjacent Hall microsensors, comprising a silicon substrate and four contacts, providing simultaneously two supply inputs and two differential outputs, are characterized. The voltage related sensitivity is in the order of $0.11T^{-1}$, and a cancellation method for offset compensation is used, achieving residual offset in the micro scale which is also compared to a single Hall plate.

Keywords—Adjacent Hall sensors, offset compensation, voltage related sensitivity, $0.18\mu\text{m}$ CMOS technology.

I. INTRODUCTION

A hall element is used for contactless measurement, for example as linear and angular positions, electrical current and power, etc. The Hall element, fabricated as specialized integrated circuits by means of CMOS technology gives a weak output signal (of the order of few millivolts). This signal is corrupted of offset and noise [1]. The reasons for these drawbacks are geometrical errors in mask alignment, crystal damage, mechanical strain and stress, non-uniform temperature distribution and heat dissipation in the substrate, thermoelectric voltage across Hall leads, non-homogeneities, etc. Different methods for offset compensation are known, as improvement of the manufacturing technologies, device symmetry, calibration, mutual compensation, trimming, spinning current offset reduction, etc [2]. The magnetic sensitivity or the transduction efficiency is the most important figure of merit of the magnetosensitive devices and all other types of sensors. This parameter is the ratio of the variation in the output signal to the variation in the external magnetic field at a constant temperature, pressure, radiation, etc. It determines the conversion efficiency of the input quantity (the magnetic field B) into electric output signal. The options for enhancing sensitivity S are: 1) optimization of geometrical sizes of the Hall structures so that the geometrical factor G has maximum limit value, $G \approx 1$; 2) using semiconducting materials as $n\text{-GaAs}$, $n\text{-InSb}$, $n\text{-Si}$, etc. with low value of the

electron concentration in the Hall plate substrate n (accordingly, with high carrier mobility μ) or 3) small thickness t of the sensor [3]. Therefore, the offset and the voltage related sensitivity are key characteristics for a Hall effect transducer. They describe its behavior to a degree that will allow one to design it into a larger system.

II. SENSORS LAYOUT AND OPERATION PRINCIPLE

The investigated sensors are symmetrical with dimensions $20 \times 20 \mu\text{m}$ and placed side by side (Fig. 1) and $40 \times 40 \mu\text{m}$ diagonal (Fig. 2).

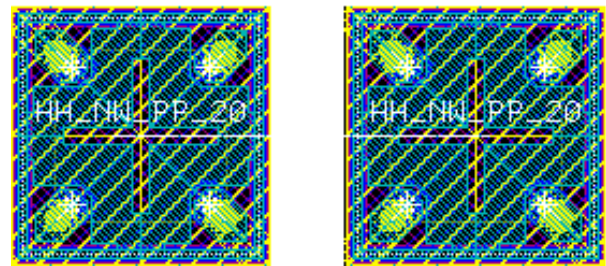

Fig. 1 Side by side Hall plates

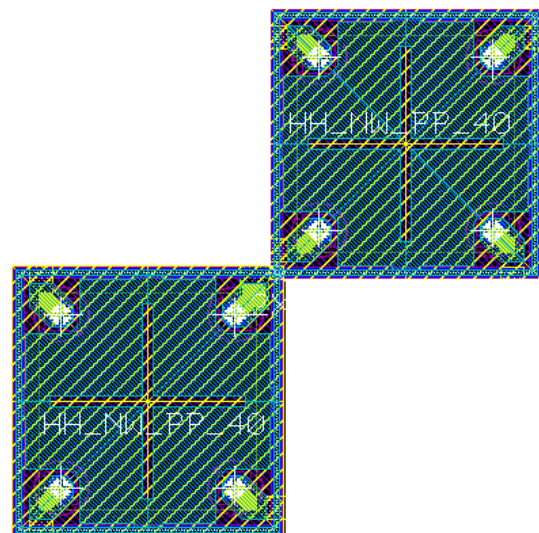

Fig. 2 Diagonal Hall plates

The investigated sensors are with higher degree of symmetry, they are invariant under 90° rotation and the input and output terminals are interchangeable. The Hall devices have equivalent contacts and therefore some compensation methods can be used to suppress the offset.

I. N. Cholakova is with the Technical University of Sofia, Faculty of Electronic Engineering and Technology, Bulgaria (phone: 0035929653085; e-mail: inch@ecad.tu-sofia.bg).

T. B. Takov is with the Technical University of Sofia, Faculty of Electronic Engineering and Technology, Bulgaria (e-mail: takov@ecad.tu-sofia.bg).

R. Ts. Tsankov is with the Melexis, Bulgaria (e-mail: rts@melexis.com).

N. Simonne is with the Melexis, Bulgaria (e-mail: nsm@melexis.com).

S. S. Tzanova is with the Technical University of Sofia, Faculty of Electronic Engineering and Technology, Bulgaria (e-mail: slavka@ecad.tu-sofia.bg).

The Hall microsenors were manufactured in a standard planar technology on p-Si wafers, with substrate resistivity 0,01 Ωcm and crystallographic direction (100). The heavy doped n+ regions are with depth of 35nm and STI (shallow trench isolation) depth is 400nm. The microdevices are confined in N-well, which serves as an active sensor zone with depth of 1.5 μm . The sensors are composed of 3.3V N-well and n-implantation for the contacts. Fig. 3 illustrates the measurement principle.

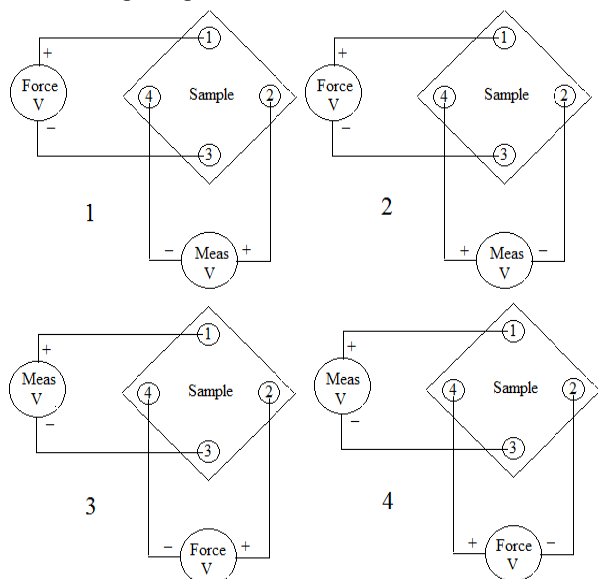

Fig. 3 Four-phase spinning measurement method

The measurements involve forcing a voltage (from 0.5V to 3.0V with step 0.5V) and measuring a voltage (Hall voltage). The basic idea of the four-phase spinning approach lies in reconnection of the relevant contact pairs, whereas the bias contacts become output contacts, and the supply contacts are used as sense terminals. Due to the fact that the Hall structure is symmetric with rotation, this technique leaves the output Hall voltage V_H unchanged in value and sign. The Hall sensor can be presented as a Wheatstone bridge and the inevitable ohmic offset can be represented as a small difference ΔR in value of some of the four otherwise identical leg resistors, for example $(R_3 + \Delta R) \neq R_1, R_1 = R_2 = R_4$. So, The Hall sensor is not symmetric with respect to the location of this “leg resistor” in the Wheatstone bridge. During the terminals’ rotation, this results in polarity reversion of the offset voltage. The net effect is “to see” the Hall signal as rotating in the same direction as the bias voltage, while the ohmic offset rotates in the opposite direction. If those two periodic measurements of the output voltage $V_H + V_{OFF}$ and $V_H - V_{OFF}$ are averaged, the true value of the output Hall voltage will be obtained [4]. The output voltage for semiconductors is typically about mV.

III. EXPERIMENTAL RESULTS

A test chip was designed with Hall sensors on 0.18 μm CMOS technology. The purpose of the chip is to test different Hall structures and to find the optimum one for future projects in this technology. A four-phase spinning method is used for

offset compensation, which involves a combination of reversing source voltage polarity and also reversing the input and output terminals. For this purpose the test equipment shown on Fig. 4 was prepared.

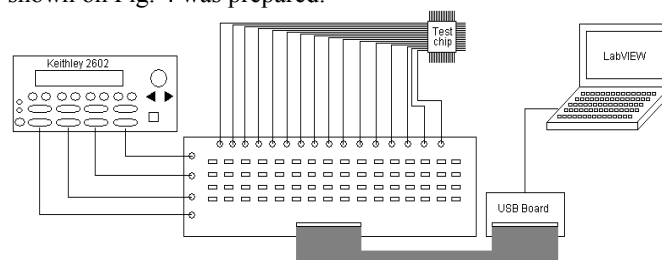

Fig. 4 Test equipment

The equipment gives the opportunity four Hall plates to be tested at once. It is composed of one switch matrix board with 64 relays which switch the Hall plates’ diagonals for offset compensation. Also for chip measurements a Keithley 2602 was used, which is duo channel source meter with 10 000 readings/s and 5500 source-measure points/s to memory. The first channel is used to supply the sensors and the second one is used to measure the output signal. The plates are tested with six supply voltages (0.5V, 1.0V, 1.5V, 2.0V, 2.5V, 3.0V). A LabVIEW program was created in order more automated test process to be achieved. Its functions are to drive the Keithley and the switch matrix board, so consecutively to supply and measure all diagonals of the tested four Hall structures.

The results for the residual offset, measured using the 4-phase spinning technique are shown in Table I.

TABLE I
 RESIDUAL OFFSET IN μV

V_{DD} , V	0.5	1.0	1.5	2.0	2.5	3.0
20 μm cell	-0.72	0.37	0.07	2.17	1.24	-1.04
20 μm side by side cells	-1.77	2.52	0.59	2.14	0.003	-1.72
40 μm cell	-1.81	-2.51	-3.46	-1.44	-1.88	-3.06
40 μm diagonal cells	-1.60	-0.90	-3.10	-3.70	-4.00	-0.70

In order the mutual interaction to be assessed a single cell and the adjacent cells were investigated. Fig. 5 and Fig. 6 illustrate a comparison between 20 μm single cell and double 20 μm cells placed side by side, and respectively 40 μm single cell and 40 μm double cells placed diagonally.

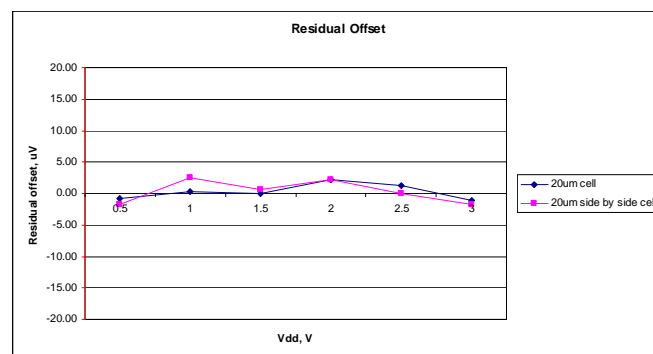

Fig. 5 Comparison of single and double 20 μm cells

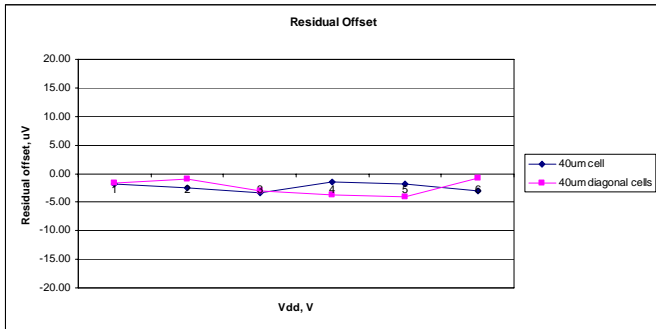

Fig. 6 Comparison of single and double 40µm cells

As it can be seen from the table the residual offset variation is in the order of 2µV at supply voltage 2.5V. This variation can be due to some equipment inaccuracy, which is not out of our specification. This proves that the cells placed side by side and diagonal do not influence each other in a negative way and the sensors' characteristics cannot be affected.

Next measurements concern the investigation of the Hall voltage as a function of the applied voltage supply and the applied magnetic field. In order the magnetic measurements to be performed, a circle test board was designed and implemented, where the necessary leads of the chip are connected to the switch matrix board (Fig. 7).

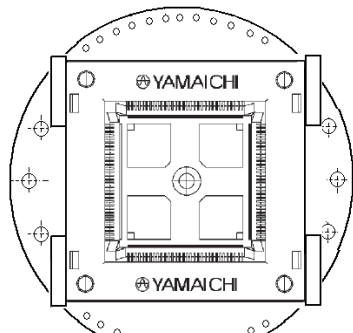

Fig. 7 Circle test board

The higher measured value of the Hall voltage is nearly 2.7mV at Vdd = 3V. Fig. 8 illustrates the output signal as a function of the increasing supply voltage.

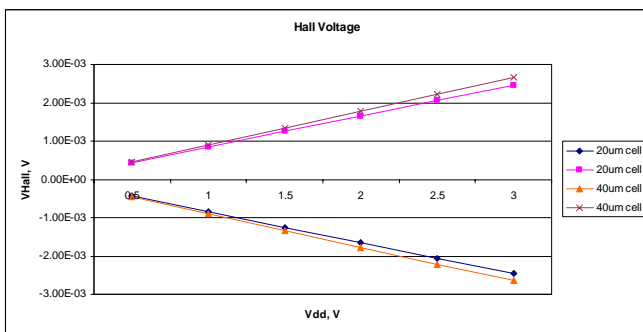

Fig. 8 Hall voltage as a function of the supply voltage

The magnetic field is applied perpendicular to the Hall plate's surface. Next, the Hall voltage nonlinearity is investigated. Measurements are made at constant supply at magnetic fields -8mT, 0T and 8mT (Fig. 9 for 20µm side by side cells and Fig. 10 for 40µm diagonal cells).

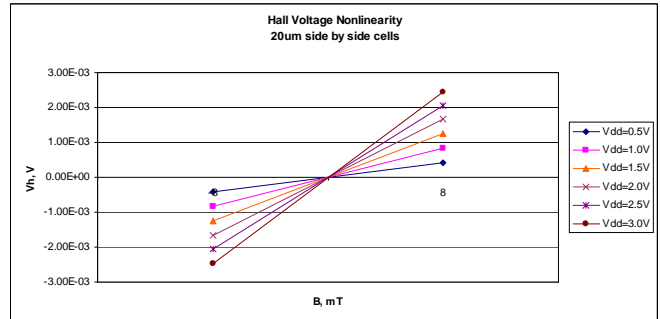

Fig. 9 Hall voltage as a function of the applied magnetic field

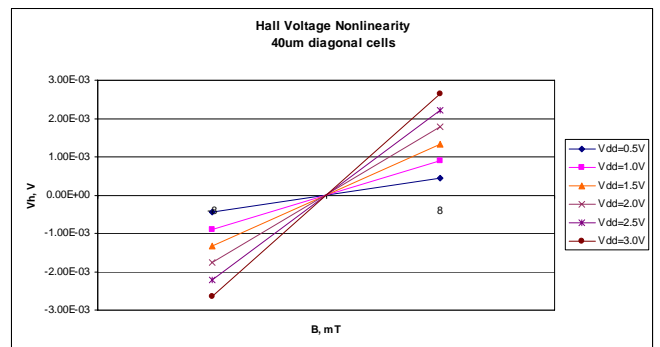

Fig. 10 Hall voltage as a function of the applied magnetic field

In some applications of Hall effect sensors as magnetic sensors, it is particularly important that the proportionality relation $V_H \sim I_{DD}B$ or $V_H \sim V_{DD}B$ holds to a high degree of accuracy. Here V_H denotes the measured Hall voltage at bias current I_{DD} or bias voltage V_{DD} and at magnetic field B . The results flatly illustrate that the output voltage of the investigated microsensors is linear in both directions of the magnetic field.

Also voltage related sensitivity is measured and investigated (Table II).

TABLE II
 VOLTAGE RELATED SENSITIVITY IN T⁻¹

V _{DD} , V	0.5	1.0	1.5	2.0	2.5	3.0
B, mT	8.0	8.0	8.0	8.0	8.0	8.0
20µm cell	0.104	0.104	0.104	0.103	0.103	0.102
40µm cell	0.111	0.111	0.111	0.110	0.110	0.110

Then, the sensitivity is calculated using (1):

$$S_V = \frac{V_H}{V_{DD} B}, T^{-1}. \quad (1)$$

S_V is the voltage related sensitivity, V_H is the Hall voltage, V_{DD} is the supply voltage and B is the applied magnetic field. Fig. 11 illustrates the results.

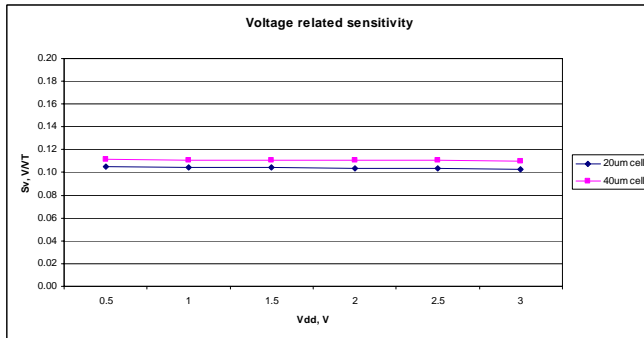

Fig. 11 Voltage related sensitivity

The achieved sensitivity is 0.10 T⁻¹ for the 20µm cell and 0.11 T⁻¹ for 40µm cell. The difference in the sensitivity of the both cells is due to the fact that they are with different size (20µm and 40µm). From Fig. 11 the stability of the sensors' voltage related sensitivity as a function of the increasing supply voltage is clearly visible. As a comparison, a typical value for voltage related sensitivity in the literature is 0.05 to 0.08 T⁻¹. We obtained much higher sensitivity which is a key characteristic for such type magnetic devices.

IV. CONCLUSION

This paper has reported the design, operation and characterization of horizontal adjacent silicon Hall microsensors. The devices are symmetrical and contain four contacts. The Hall structures for magnetic field, giving a linear Hall voltage and high sensitive signal are presented and tested. The Hall elements are ready for a wide range of practical applications, as metrology, automotive industry, robotics, remote sensing, etc. The main conclusion is that the class of 0.18µm CMOS integrated circuit Hall sensors, with proved advantages, is promising and can successfully compete with other horizontal microdevices.

ACKNOWLEDGMENT

This work is funded with support from the SCOPES project "Skills development for young researchers and educational personal in nano and microelectronics curricula: implementation of methods for bilateral knowledge transfer between universities and SMEs", no. IZ74Z0_137353 and Contract no. 122PD0060-03.

REFERENCES

[1] Z. B. Randjelovic, M. Kayal, R. Popovic and H. Blanchard "Highly Sensitive Hall Magnetic Sensor Microsystem in CMOS Technology," IEEE Journal of Solid-State Circuits, vol. 37, No 2, 2002, pp. 151-159.

[2] S. Lozanova, Ch. Roumenin "A novel parallel-field double – Hall microsensor with self-reduced offset and temperature drift", Science Direct, Procedia Engineering 5, 2012, pp. 617-620.
 [3] C. S. Roumenin "Solid State Magnetic Sensor", Handbook of Sensors and Actuators, Vol. 2, Elsevier, 1994.
 [4] C. Roumenin, S. Noykov, S. Lozanova "Three Contact Parallel-Field Hall Microsensor With Dynamically Reduced Offset And 1/f Noise", Comptes rendus de l'Academie bulgare des Sciences, Vol. 63, No. 4, 2012, pp. 609-615.