

A Comparative Analysis of Modulation Control Strategies for Cascade H-Bridge 11-Level Inverter

Joshi Manohar. V., Sujatha. P., and Anjaneyulu K. S. R

Abstract—The range of the output power is a very important and evident limitation of two-level inverters. In order to overcome this disadvantage, multilevel inverters are introduced. Recently, Cascade H-Bridge inverters have emerged as one of the popular converter topologies used in numerous industrial applications. The modulation switching strategies such as phase shifted carrier based Pulse Width Modulation (PWM) technique and Stair case modulation with Selective Harmonic Elimination (SHE) PWM technique are generally used. NR method is used to solve highly non linear transcendental equations which are formed by SHEPWM method. Generally NR method has a drawback of requiring good initial guess but in this paper a new approach is implemented for NR method with any random initial guess. A three phase CHB 11-level inverter is chosen for analysis. MATLAB/SIMULINK programming environment and harmonic profiles are compared. Finally this paper presents a method at fundamental switching frequency with least % THD_v.

Keywords—Cascade H-bridge 11- level Inverter, NR method, Phase shifted carrier based pulse width modulation(PSCPWM), Selective Harmonic Elimination Pulse Width Modulation (SHEPWM), Total Harmonic Distortion (%THD_v).

I. INTRODUCTION

NOW-A-DAYS industrial applications needs higher power rating which reached to mega watt range. For a medium voltage grid, it is troublesome to connect only one power semiconductor switch directly [1]. As a result, multilevel power converter structure has been introduced as an alternative in high power and medium voltage applications.

A multilevel converter not only achieves high power ratings, but also enables the use of renewable energy sources such as photovoltaic, wind, and fuel cells can be easily interfaced to a multilevel converter system for medium voltage high power drives, distributed energy sources and hybrid electric vehicles [2], [3]. The range of output power is limited in two level inverters, this disadvantage is overcome by multilevel inverter and they have features such as high reliability due to its modular topology, less distorted input current and less switching losses [4].

V. Joshi Manohar is Research Scholar at the Electrical Engineering Department, JNTU Anantapur, India (phone: +91-9912376009; e-mail: vjoshimanohar@gmail.com).

P. Sujatha is Professor and HOD at the Electrical Engineering Department, JNTU College of Engineering, Anantapur, India (e-mail: psujatha1993@gmail.com).

K. S. R. Anjaneyulu is Professor at the Electrical Engineering Department, JNTU College of Engineering, Anantapur, India (e-mail: ksralu@yahoo.co.uk).

Three multilevel converter topologies have commercially come into existence: Neutral Point Clamped (NPC), cascade H-bridge (CHB) and Flying Capacitors (FCs) [5]. Depending upon switching frequency the modulation strategies are classified into low switching frequency (fundamental switching frequency and high switching frequency. High switching frequency methods employ switching frequency in order of several kHz.

The major advantage of traditional PWM methods employing much higher frequencies concerns harmonics but some times higher frequency causes undesirable harmonics where filtering is much easier and less expensive. Also, there is no power dissipation because generated harmonics might be above the band width of actual systems. But high switching frequency leads to high switching losses there by less converter efficiency, especially when used in high power applications [6]. Fundamental switching frequency results in less switching losses and less thermal losses, which results high converter efficiency. This method is best suited for MV drives. However, this method produces lower order of harmonics.

This paper is organized as follows: Section II presents brief review on Cascade H-bridge 11-level inverter. Section III presents phase shifted carrier based PWM technique. Section IV presents Selective Harmonic Elimination PWM technique and solving non linear transcendental trigonometric equations by using Newton-Raphson method with any random initial guess. Both the methods are simulated in MATLAB/SIMULINK and comparative harmonic analysis is carried out in Section V.

II. CASCADE MULTILEVEL INVERTER

Among the topologies of multilevel inverter mentioned in Section I, Cascade Multilevel Inverter (CMLI) is one of the most important topology because of following features such as: no specially designed transformer is needed as compared to multi pulse inverter, modular structure with simple switching strategy, occupies less space and ability to synthesize better harmonic spectrum [7].

The CMLI usually consists of a number of H-bridge inverter units with separate dc source for each unit and is connected in cascade or series as shown in Fig. 1. Each H-bridge can produce three different voltage levels: $+V_{dc}$, 0, and $-V_{dc}$. The AC output voltage of each H-bridge is connected in series such that the synthesized output voltage waveform is the sum

of all of the individual H-bridge output voltages. By connecting the sufficient number of H-bridges in cascade and using proper modulation scheme, a nearly sinusoidal output voltage waveform can be synthesized.

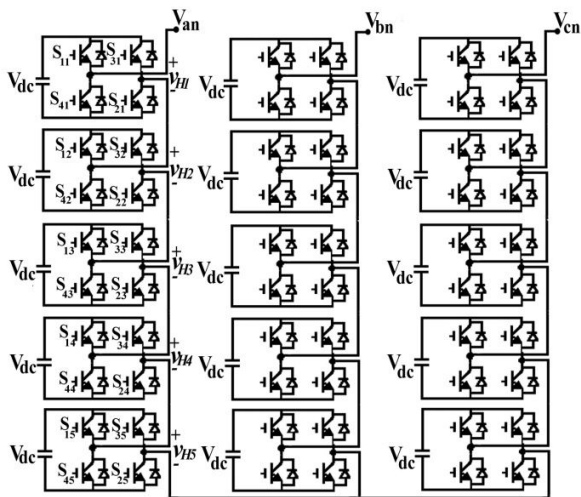

Fig. 1 Three phase cascade H- bridge 11- level inverter

The general rule for the number of levels in the output phase - to - neutral voltage in cascaded single - phase H - bridge multilevel inverter is $2s+1$, where 's' is the number of H-bridges used per phase. Fig. 3 shows an 11-level output phase voltage waveform using five H-bridges per phase. The magnitude of the ac output phase voltage is sum of output voltages of all H bridges in phase. For

$$V_{an} = V_{H1} + V_{H2} + V_{H3} + V_{H4} + V_{H5} \quad (1)$$

III. MODULATION CONTROL TECHNIQUES

The modulation control techniques for multi level inverters can be classified according to switching frequency [1]. Modulation techniques which have many commutations for the power semiconductors in one period of the fundamental output voltage have high switching frequency. Very popular methods in industrial application are carrier based PWM with triangular carriers, they are: phase shifted carrier based and level shifted carrier based PWM schemes.

Modulation control techniques that work with low switching frequency generally perform one or two commutation of the power semi conductors during one cycle of the output voltage, generating stair case waveform. For this low switching frequency, popular control technique is selective harmonic elimination PWM method.

A. Phase-Shifted Carrier Based Pwm Technique

Generally, multilevel inverter with m voltage levels requires $(m-1)$ triangular carriers. All the carriers have same frequency and same peak-to- peak amplitude with phase shift. The phase shift (ϕ_{cr}) between adjacent carrier waves is given by

$$\phi_{cr} = 360^\circ / (m-1) \quad (2)$$

The modulating signal is usually a three-phase sinusoidal wave with adjustable amplitude and frequency. By comparing the modulated wave with the carrier waves gate signals are generated. For the case of simplicity seven level CHB inverter is considered as shown in Fig. 2 (a). In this case six triangular signals are required with 60° phase displacement between them. In Fig. 2 (b), phase A modulating wave (V_{ma}) is considered and carriers $V_{cr1}, V_{cr2}, V_{cr3}$ are used to generate gatings for switches S_{11}, S_{12}, S_{13} . Other three carriers $V_{cr1-}, V_{cr2-}, V_{cr3-}$ which are 180° out of phase with $V_{cr1}, V_{cr2}, V_{cr3}$. These carriers produce gatings for switches S_{31}, S_{32}, S_{33} of the H - bridge cells. The gate signals for other switches are not represented here because these switches operate in complementary manner with corresponding to their upper switches. Detailed explanation is presented in [8], [9].

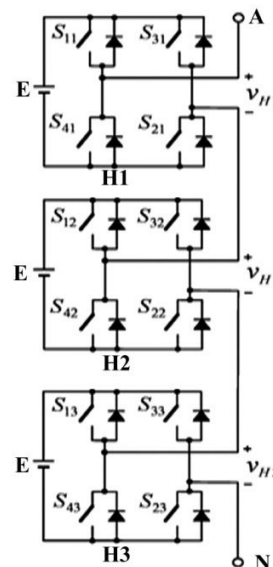

Fig. 2 (a) Per Phase diagram of CHB 7-level inverter

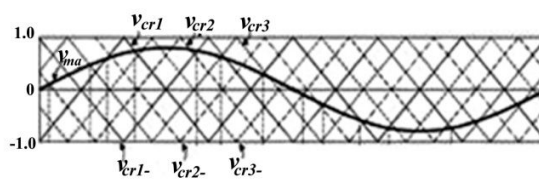

Fig. 2 (b) Carrier waves and modulating wave for Phase A in CHB 7 - Level inverter

For cascade H-bridge 11-level inverter, it needs ten triangular carrier signals with phase displacement of 36° . The carrier waves $V_{cr1}, V_{cr2}, V_{cr3}, V_{cr4}$ and V_{cr5} are used to generate gating signals for the upper switches $S_{11}, S_{12}, S_{13}, S_{14}$ and S_{15} in the left leg of power cells as shown in Fig. 1.

The carrier waves $V_{cr1-}, V_{cr2-}, V_{cr3-}, V_{cr4-}$ and V_{cr5-} are 180° out of phase with $V_{cr1}, V_{cr2}, V_{cr3}, V_{cr4}$ and V_{cr5} and produce gating signals $S_{31}, S_{32}, S_{33}, S_{34}$ and S_{35} . Developed simulink model is simulated at different modulation indices and %THDv is observed at each modulation index. The phase

voltage waveform of cascade H- bridge inverter has 11 voltage steps: +5E, +4E, +3E, +2E, +E, 0, -E, -2E, -3E, -4E and -5E.

B. Selective Harmonic Elimination Pwm Technique

Selective harmonic elimination (SHE) is a well known technique at fundamental frequency to control multilevel inverter with low switching losses and better harmonic spectrum [10]. The non linear transcendental equations which are formed by this method are solved by using NR method.

In general, the Fourier series expansion of the staircase output voltage waveform as shown in Fig. 3 is given by

$$v_{an}(\omega t) = \sum_{k=1,3,5,\dots}^{\infty} \frac{4V_{dc}}{k\pi} (\cos(k\alpha_1) + \cos(k\alpha_2) + \dots + \cos(k\alpha_s)) \sin(k\omega t) \quad (3)$$

where 's' is the number of H-bridges connected in cascade per phase. In this, five number of H-bridges are connected per phase. Where V_{dc} is the voltage of H- bridge. The angles are limited to between 0^0 and 90^0 ($0 \leq \alpha \leq 90^0$). Because of an odd quarter-wave symmetry, all even order harmonics zero. It is not necessary to eliminate triplen harmonics because they will be eliminated in the line to line output voltage. Subsequently V_1 becomes:

$$\frac{4V_{dc}}{\pi} (\cos(\alpha_1) + \cos(\alpha_2) + \dots + \cos(\alpha_s)) = V_1 \quad (4)$$

In this paper, an 11-level inverter is chosen as a case study. Thus, with five angles as degrees of freedom, it is possible to eliminate four lower order harmonics i.e. 5th, 7th, 11th and 13th.

For an 11-level inverter, the following equation should be solved:

$$\begin{aligned} [\cos(\alpha_1) + \cos(\alpha_2) + \dots + \cos(\alpha_5)]/5 &= m_1 \\ \cos(5\alpha_1) + \cos(5\alpha_2) + \dots + \cos(5\alpha_5) &= 0 \\ \cos(7\alpha_1) + \cos(7\alpha_2) + \dots + \cos(7\alpha_5) &= 0 \\ \cos(11\alpha_1) + \cos(11\alpha_2) + \dots + \cos(11\alpha_5) &= 0 \\ \cos(13\alpha_1) + \cos(13\alpha_2) + \dots + \cos(13\alpha_5) &= 0 \end{aligned} \quad (5)$$

where M_1 is modulation index and defined as

$$M_1 \triangleq \pi V_1 / 4sV_{dc} \quad (0 \leq M_1 \leq 1) \quad (6)$$

In general, the set of (5) can be written in a compact form as

$$F(\alpha) = B(M_1) \quad (7)$$

where, the vectors $F(\alpha)$ and $B(M_1)$ are functions of switching angles and modulation index respectively.

The set of (5) are five non linear transcendental trigonometric equations, known as selective harmonic elimination (SHE) equations, can be solved by a number of numerical methods [10], one of the fastest iterative methods is Newton Raphson method [11], [12]. This method begins with any random initial guess and generally converges at a zero of a given system of non linear equations.

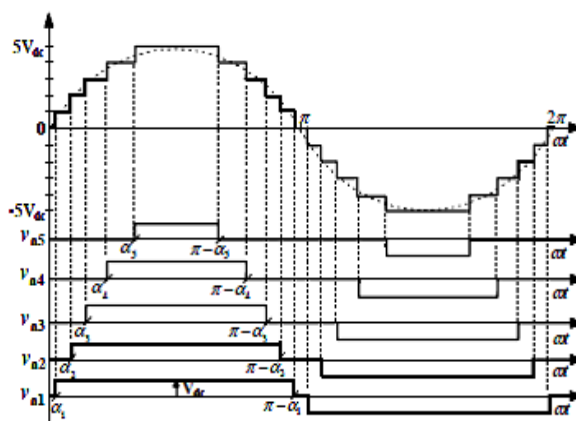

Fig. 3 Output phase voltage waveform of CHB 11-level inverter

The algorithm for The Newton-Raphson method is as follows:

1. Assume any random initial guess for switching angles (say α_0) such that
2. $0 \leq \alpha_1 < \alpha_2 \dots \dots < \alpha_5 \leq \frac{\pi}{2}$
3. Set $M_1 = 0$.
4. Calculate $F(\alpha_0)$, $B(M_1)$ and jacobian matrix $J(\alpha_0)$.
5. Compute correction $\delta\alpha$ during the iteration using relation. $\Delta\alpha = J^{-1}(\alpha_0)(B(M_1) - F(\alpha_0))$.
6. Update the switching angles i.e. $\alpha(k+1) = \alpha(k) + \Delta\alpha(k)$
7. Perform the $\alpha(k+1) = \cos^{-1}(\text{abs}(\cos(\alpha(k+1))))$ transformation to bring switching angles in feasible range i.e. between zero and $\pi/2$.
8. Repeat the steps (3) to (6) for sufficient number of iterations to attain error goal.
9. Substitute $\alpha_0 = \alpha(k+1)$
10. Repeat steps (2) to (8) for whole range of M_1 .
11. Increment M_1 by a fixed step.
12. Repeat steps (2) to (10) for complete range of M_1 .

The above algorithm is implemented in MATLAB programming environment and the complete analysis is presented in Section IV.

IV. SIMULATION AND ANALYSIS

The developed code and simulink model is simulated by using MATLAB/SIMULINK and comparative analysis is presented for both modulation strategies.

A. Phase Shift Carrier Based PWM Technique

Phase shift carrier based PWM technique is applied on three phase cascade H-bridge 11-level inverter. The developed simulink model is run at various modulation indices from 0 to 1 and at each step %THD_v is observed, these values are tabulated in Table I, the simulated output voltage at modulation index 1.0 and FFT analysis are presented in Figs. 4 and 5 respectively.

TABLE I
%THD_v VS MODULATION INDICES

S.No	M _i	%THD _v
1	0.1	138.86
2	0.2	68.70
3	0.3	63.53
4	0.4	56.61
5	0.5	40.66
6	0.6	30.59
7	0.7	26.92
8	0.8	24.20
9	0.9	19.75
10	1	13.85

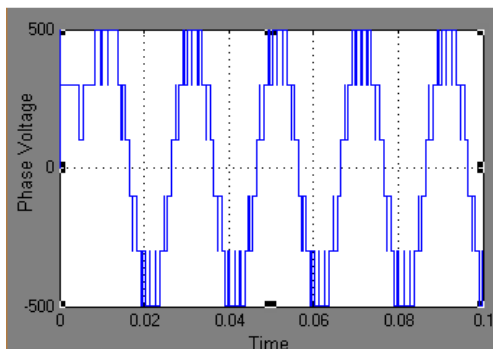

Fig. 4 Output phase voltage waveform for M_i = 1.0

From above results in Table I, it is observed that %THD_v decreases as modulation index increases and minimum %THD_v observed at modulation index 1, which is found to be 13.83%. From FFT analysis in Fig. 5, it is observed that harmonics of 5th, 7th, 11th and 13th orders are still present in output voltage. In order to bring this value to comply IEEE 519-1992 guidelines additional filters are needed, which are quite expensive.

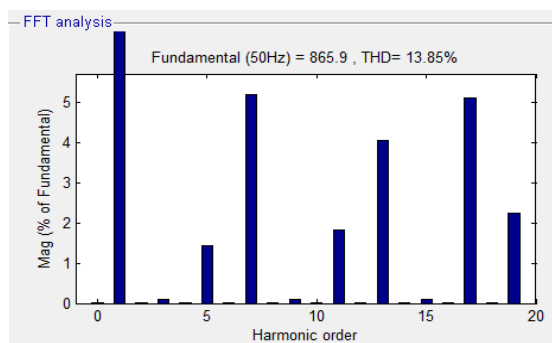

Fig. 5 FFT analysis representing harmonic order of voltage harmonics at M_i = 1

B. Selective Harmonic Elimination PWM Technique

The non linear transcendental equations which are formed by SHE method are solved by Newton Raphson algorithm. The new approach in developed algorithm is, it can work with any random initial guess. By incrementing M_i from 0 to 1 in steps of 0.001, all solution sets are computed. Graph between switching angles versus modulation indices are shown in Fig. 6.

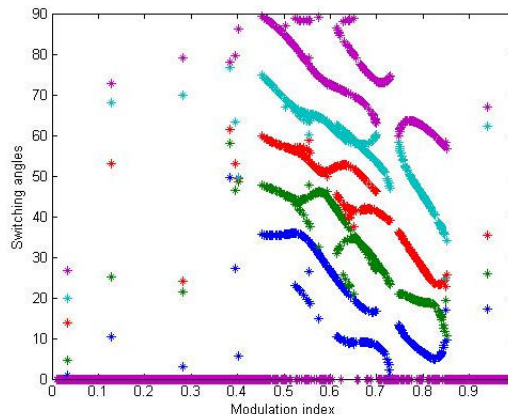

Fig. 6 Switching angles Vs modulation Indices

It can be seen from Fig. 6 that solutions do not exist at lower and upper ends of the modulation indices and also for M_i = [0.300 0.434], and [0.732 0.742] as error is not zero at these values of M_i. Multiple solution sets exist for M_i = [0.510 0.569], [0.615 0.700]. Some solutions are existing in very narrow range of M_i i.e. at [0.365], [0.387], [0.900], [0.933] and [0.982]. The developed NR algorithm is simulated at different modulation indices in feasible region and at each modulation index %THD_v and switching angles are tabulated in Table II. From Table II, it is observed that least %THD_v i.e 5.33% is produced at modulation index of M_i = 0.755.

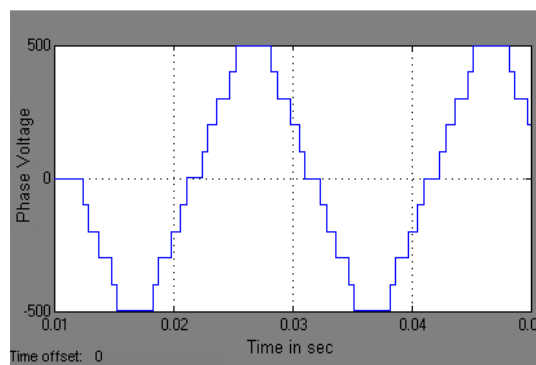

Fig. 7 Output Phase voltage waveform of SHEPWM at M_i = 0.755

TABLE II
%THD_v & SWITCHING ANGLES IN DEGREES

S.No	M _i	α ₁	α ₂	α ₃	α ₄	α ₅	%THD _v
1.	0.460	35.46	47.39	59.32	73.95	88.73	8.81
2.	0.473	35.33	46.87	58.47	72.40	87.68	8.62
3	0.485	35.33	46.32	57.82	70.96	86.56	8.98
4	0.495	35.44	45.78	57.39	69.77	85.49	8.88
5	0.500	35.52	45.49	57.20	69.20	84.92	8.77
6	0.555	33.75	44.94	53.54	65.22	77.14	7.60
7	0.600	26.64	43.93	51.53	62.39	72.50	7.24
8	0.655	18.98	34.82	51.33	57.94	69.32	6.32
9	0.750	12.79	21.01	35.81	56.59	61.31	5.63
10	0.755	11.66	20.93	34.83	54.41	62.67	5.33
11	0.800	6.569	18.94	27.18	45.13	62.24	5.55

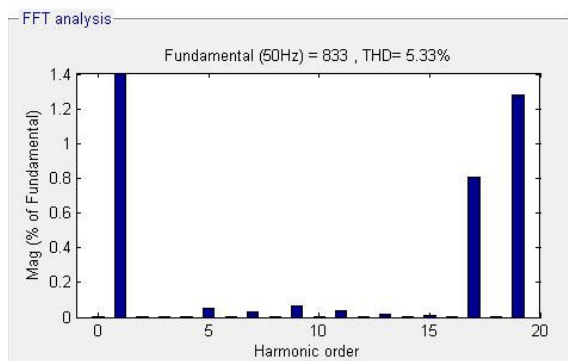

Fig. 8 FFT Analysis representing order of voltage harmonics at $M_1 = 0.755$

This value of %THD also satisfies IEEE 519-1992 harmonic guidelines. The output phase voltage waveform and FFT analysis at $M_1 = 0.755$ are shown in Figs. 7 and 8 respectively. FFT analysis shows all the lower order of the voltage harmonics such as 5th, 7th, 11th and 13th are minimised.

V. CONCLUSIONS

In this paper comparative analysis is carried out for Phase shifted carrier based pulse width modulation and Selective harmonic PWM strategies, which are applied to three phase cascade H-bridge 11-level inverter. A new approach is proposed in solving non linear transcendental SHE equations by NR method with any random initial guess. By observing the results in section IV, it is observed that least %THD_v is obtained in SHEPWM control strategy. Its value is found to be 5.33% at modulation index of $M_1 = 0.755$ and it also satisfies IEEE 519-1992 harmonic guidelines. It is also observed from FFT analysis in Fig. 8, all the lower order of harmonics i.e 5th, 7th, 11th, 13th are minimised and the switching angles at that instant are presented in Table II. Hence this control strategy is well suited for applications where there is need to eliminate lower order harmonics such as Medium voltage high power drives. Though, Newton-Raphson method is fast iterative method but it needs good initial guess. In order to overcome that draw back, a new approach is presented here to solve non linear transcendental equations by NR method with any random initial guess. However, this method is having a limitation of using for whole range of modulation index. It can be seen in Fig. 6, there are regions where there is no solution for SHE equations in NR method. Further, Intelligent Algorithms such as Genetic Algorithm (GA) and Particle Swarm Optimisation (PSO) may be used to minimize harmonics in that region.

REFERENCES

[1] Jose Rodriguez, J S Lai, and F. Z. Peng, "Multilevel Inverters: A Survey of Topologies, Controls, and Applications", IEEE Trans. Ind.Electron., vol. 49, no. 4, pp. 724-738, August 2002.
[2] K.Gopa Kumar, A.Das, R.Ramchand,C.Patel, "A hybrid multilevel topology for an open-end winding induction motor drive using two-level inverters in series with a capacitor fed H-bridge cell," IEEE Trans. Ind.Electron., Vol. 57, No. 11,pp. 3707-3714, Nov.2010.

[3] Fang Zheng Peng, Jih-Sheng Lai, et al, "A Multilevel Voltage-Source Inverter with Separate DC Sources for Static Var Generation", IEEE Trans. Ind. Appl., vol. 32, no. 5, pp. 1130-1138, Sep/Oct. 1996.
[4] M.Malinowski, K. Gopakumar, J.Rodriquez, and M. A. Perez,"A survey on cascaded multilevel inverters," IEEE Trans. Ind.Electron., Vol. 57, No. 7,pp. 2197-2206, Jul. 2010.
[5] J.S.Lai, and F.Z.Peng "Multilevel converters – A new breed of converters," IEEE Trans. Ind.Appl., vol.32, no.3, pp.509-517. May/Jun.1996.
[6] Samir Kouro, S. La Rocca, B. Cortes, P. Alepuz, S. Bin Wu Rodriguez, J. "Predictive control based selective harmonic elimination with low switching frequency for multilevel converters" Energy Conversion Congress and Exposition, 2009. ECCE 2009. IEEE, pp- 3130 – 3136.
[7] P.W. Hammond, "A new approach to enhance power quality for medium voltage AC drives," IEEE Trans. Ind.Appl., vol.33, no 1, pp202-208, Jan/Feb.1997.
[8] Bin Wu, "High -Power Converters and AC Drives". Piscataway,NJ: IEEE Press, 2006
[9] Leopoldo Garcia Franquelo, Javier Napoles,"A Flexible Selective Harmonic Mitigation Technique to Meet Grid Codes in Three-Level PWM Converters," IEEE Trans. Ind. Electron., vol. 54, no. 6, pp 3022-3029, Dec 2007.
[10] A.Tahri and A.Draou "A Comparative Modelling Study of PWM Control Techniques for Multilevel Cascaded Inverter" Leonardo Journal of Sciences, Issue 6, pp 42-58, Jan-Jun 2005.
[11] H. S. Patel and R. G. Hof, "Generalized harmonic elimination and voltage control in thyristor inverters: Part I—Harmonic elimination," IEEE Trans.Ind. Appl., vol. IA-9, no. 3, pp. 310-317, May/Jun. 1973.
[12] H. S. Patel and R. G. Hof, "Generalized harmonic elimination and voltage control in thyristor inverters: Part II—Voltage control technique," IEEE Trans. Ind. Appl., vol. IA-10, no. 5, pp. 666-673, Sep./Oct. 1974.



V.Joshi Manohar received B.Tech degree in Electrical & Electronics Engineering from Nagarjuna University, Guntur, AP, India in 2000 and M.Tech degree in Power Electronics from Visveswaraiah Technological University, Belgaum, KA, India in 2004. Presently he is pursuing Ph.D degree from J.N.T.U. College of Engineering, Anantapur AP, India. Currently he is with the Dept of Electrical and Electronics Engineering, Guntur Engineering College, Guntur, India. His area of research includes Industrial Drives and Optimisation Techniques. He is Life Member of ISTE.



P.Sujatha is presently working as Professor & HOD of Electrical and Electronics Engineering department, J.N.T.U.College of Engineering, Anantapur, Andhra Pradesh, India. She completed her B.Tech, M.Tech and Ph.D. degrees in Electrical Engineering from J.N.T.U. College of Engineering, Anantapur, Andhra Pradesh, India in 1993, 2003 and 2012 respectively. She has nearly 15 years of teaching experience and her area of interest includes Reliability Engineering with emphasis to Power Systems and Real time Energy Management.



K.S.R. Anjaneyulu has completed his B.Tech, M.Tech and Ph.D. degrees in Electrical Engineering from Jawaharlal Nehru Technological University, Hyderabad, AP, India in 1982, 1985 and 1999 respectively. He has joined in department of Electrical Engineering, Jawaharlal Nehru Technological University, Anantapur, AP, India as a lecturer in 1985. Currently he is Professor in Electrical Engineering in JNTU College of Engg, Anantapur, India. His research interest includes Power Systems and Intelligent Techniques. He is Fellow of Institution of Engineers (I), Life Member of ISTE and Indian Society of Power Engineers (ISPE).