

# Novel Dual Stage Membrane Bioreactor for the Continuous Remediation of Electroplating Wastewater

B. A. Q. Santos, S. K. O. Ntwampe, and G. Muchatibaya

**Abstract**—In this study, the designed dual stage membrane bioreactor (MBR) system was conceptualized for the treatment of cyanide and heavy metals in electroplating wastewater. The design consisted of a primary treatment stage to reduce the impact of fluctuations and the secondary treatment stage to remove the residual cyanide and heavy metal contaminants in the wastewater under alkaline pH conditions. The primary treatment stage contained hydrolyzed *Citrus sinensis* (*C. sinensis*) pomace and the secondary treatment stage contained active *Aspergillus awamori* (*A. awamori*) biomass, supplemented solely with *C. sinensis* pomace extract from the hydrolysis process. An average of 76.37%, 95.37%, 93.26 and 94.76% and 99.55%, 99.91%, 99.92% and 99.92% degradation efficiency for total cyanide (T-CN), including the sorption of nickel (Ni), zinc (Zn) and copper (Cu) were observed after the first and second treatment stages, respectively. Furthermore, cyanide conversion by-products degradation was 99.81% and 99.75 for both formate (CHOO<sup>-</sup>) and ammonium (NH<sub>4</sub><sup>+</sup>) after the second treatment stage. After the first, second and third regeneration cycles of the *C. sinensis* pomace in the first treatment stage, Ni, Zn and Cu removal achieved was 99.13%, 99.12% and 99.04% (first regeneration cycle), 98.94%, 98.92% and 98.41% (second regeneration cycle) and 98.46%, 98.44% and 97.91% (third regeneration cycle), respectively. There was relatively insignificant standard deviation detected in all the measured parameters in the system which indicated reproducibility of the remediation efficiency in this continuous system.

**Keywords**—*Aspergillus awamori*, *Citrus sinensis* pomace, electroplating wastewater remediation, membrane bioreactor.

## I. INTRODUCTION

ELECTROPLATING is a process whereby a thin layer of a metal is coated onto an object by the electrolytic decomposition of a metal salt, such as weak acid dissociable cyanide (WAD-CN) in a solution. Cyanide based operations produce wastewater containing significant concentrations of free cyanide (F-CN) and heavy metal contaminants [1].

Although, there is an overwhelming popularity to use conventional chemical and/or physical methods for the

treatment of cyanide and heavy metal bearing wastewater compared to biological treatment methods. However, due to the high capital investment/operational costs involved, many industries do not or partially treat their wastewater [2], [3]. This is due to the fact that the regulation of industrial wastewater discharge standards is not being properly monitored.

Similarly, solid waste generation is problematic with the majority of landfill sites reaching their maximum capacity. An emerging process for the removal of heavy metals in wastewater is the application of biomaterials, such as agricultural residue and microbial biomass [3]. A variety of heavy metal contaminants have been successfully removed from wastewater utilizing biomaterials [4], [5]. Similarly, the use of some microorganisms which possess catalytic mechanisms to convert cyanides in wastewater has also been studied [6], [7]. However, the use of agricultural residue, particularly those that contain free hydroxyl functional groups, as pseudo-biocatalysts for cyanide conversion has not been reported in literature. One of the biggest contributors of agricultural residues is from citrus fruit processing which has an approximate process quantity of 31.2 x 10<sup>6</sup> tones every year globally which generates approximately 15.6 x 10<sup>6</sup> tones of citrus residue, of which 75% is *C. sinensis* or “sweet orange” pomace making it the largest contributor [8], [9]. The hydrolysis of *C. sinensis* pomace can yield significant quantities of neutral sugars, such as glucose and fructose with lower yields of arabinose, galactose, xylose and trace quantities of other neutral sugars, and uronic acids, with galacturonic acid being the predominate uronic acid liberated with trace quantities of other uronic acids [10].

Although, the use of agricultural residues has shown a huge potential as a feed stock for the cultivation of microorganisms and/or production of enzymes that can be used to catalyze various processes, there is limited studies showing this for the degradation of cyanides and removal of heavy metals [8], [11], [12]. Filamentous aerobic fungi of the *Aspergillus* sp. section *Nigri* are commonly known for their ability to breakdown and utilize complex sugars, such as lignocellulose present in agricultural residues, to simpler components of the sugars to support its metabolic activities [12]. Furthermore, they also possess the ability to degrade and metabolize of cyanides and remove heavy metals [4], [7].

Since the early 1970's, progress has been made to develop economically viable continuous biological treatment processes

B. A. Q. Santos and G. Muchatibaya are with the Faculty of Applied Science, Department of Agriculture and Food Science, Cape Peninsula University of Technology, Cape Town, South Africa (e-mail: 208035060@mycput.ac.za, muchatibayag@cput.ac.za).

S. K. O. Ntwampe is with the Faculty of Applied Science, Department of Agriculture and Food Science, Cape Peninsula University of Technology, Cape Town, South Africa (phone: +27-21-460-9097/3430; fax: +27 (0)21-460 3282; e-mail: ntwampes@cput.ac.za).

This research was sponsored by a CPUT University Research Foundation (URF RK16).

[13]. In certain instances, multiple stages are used to control transfer rates and thus improve the biodegradability of the contaminants. The selection of a treatment system including its components can provide either improved conversion rates of certain components while being restrictive to others, i.e. to prevent certain components from rendering the catalyst(s) inactive as a result of the accumulative effects of contaminants in the system and/or to prevent catalyst(s) from leaving the bioreactor [14]. These are some of the design parameters which must be monitored when developing an environmentally friendly process for the combined remediation of cyanides and heavy metals. Therefore, the integration of a system utilizing agricultural residues and microorganisms for the combined remediation of cyanides and heavy metal from wastewater under alkaline conditions, which typify most industrial wastewater containing these contaminants, has not been demonstrated thus is desirable to develop such a remediation system [4], [6], [7].

## II. EXPERIMENTAL PROCEDURE

### A. Collection and Sampling of Electroplating Wastewater

The electroplating facility where the wastewater samples were collected is located in the Western Cape, South Africa, and its operations involve the plating of workpieces with Ni, Zn and/or Cu for decorative and protective purposes. The wastewater samples were collected from its municipal discharge point every 2 days during the experiments.

### B. Isolation and Culturing of Wild *Aspergillus* sp. Strain

An *Aspergillus* sp., which displayed characteristically black conidiophores of the *Aspergillus* section *Nigri*, was isolated from swabs taken at various points along a discharge drain at the electroplating facility using a selective Pectin Agar (PA) and subcultured on 2% (v/v) antibiotic (10,000 units/L Penicillin and 10mg Streptomycin/ml), Potato Dextrose Agar (PDA) as described by reference [15].

The isolate was tolerant to F-CN up to 430mg F-CN/L. However, a significant decline in microbial growth was observed after 200mg F-CN/L indicating that the isolate was suitable for the treatment of the cyanide containing wastewater. The identification of the isolate as *A. awamori* was definitively determined using a multi-gene phylogenetic analysis, using ITS,  $\beta$ -tubulin and calmodulin gene regions [15], [16]. However, an anomaly in the morphology of the conidia of the isolate was observed during the morphological analysis, indicating a possible morphological mutation in the isolate. The isolate was then subsequently grown on PDA and a spore solution was prepared. A series of dilutions was performed using the spore solution and sterile distilled water to quantify the spore concentration. The spore concentration and absorbance of the each of the spore dilutions was determined in duplicate using a direct count system in a Marienfeld Neubauer cell-counter and using a Nikon Eclipse E2000, phase contrast 1 and magnification 100 X.

Furthermore, a Jenway 6715 UV/Visible spectrophotometer was used at 750nm using sterile distilled water as a blank to develop an absorbance-spore concentration graph as described by reference [17]. A calibration graph for the spore concentration was determined by plotting absorbance versus the spore concentration.

### C. Modification Preparation of *Citrus sinensis* Pomace

The raw *C. sinensis* pomace was washed twice in distilled water to remove any free debris and was dried for 72 hours at 80°C and then ground into a fine powder ( $\geq 100\mu\text{m}$ ) using a grinder (Bosch MKM 7000). 60g of the ground residue, 800 ml distilled water and 5ml H<sub>2</sub>SO<sub>4</sub> (98%) were added and mixed in a 2L Schott bottle and a 1L solution was made using distilled water. The solution was autoclaved at 116°C for 13 minutes and cooled to room temperature [18]. The pH was adjusted to 4.5 with 1M NaOH and stirred for 5 minutes and then filtered through a No 1 Whatman filter paper using a Brüchner funnel under vacuum/pressure. The filter cake was washed with distilled water and dried at 80°C for 24 hours and then was ground to a fine powder ( $\geq 100\mu\text{m}$ ) using a grinder (Bosch MKM 7000) and stored at room temperature. The residue extract was then transferred into a 2L Schott bottle and a 2L solution was made using sterile distilled water and stored at 4°C to use as a media for the *A. awamori* isolate.

### D. Preparation of *Aspergillus awamori* Inoculum

A 100ml inoculum solution was made up adding 10ml agricultural residue extract and 1ml spore solution ( $10 \times 10^6$  spores) to a 100ml Schott bottle and a 100ml solution was made using sterile distilled water. A volume of 1ml of the inoculum solution was added to a 1.5ml Eppendorf tube and incubated at 35°C at 150rpm for 24 hours to activate the spores.

### E. Experimental Setup Construction

Five dual stage immersed MBRs were constructed according to the schematic diagrams shown in Fig. 1, and sterilized using an autoclave at 121°C for 15 minutes.

The constructed MBR systems were operated at a temperature of 40°C in which the immersed MBRs and collection bottles were shaken at 150rpm. Watson Marlow 520S and Watson Marlow 101 U/R peristaltic pumps were used to pump the electroplating wastewater and *C. sinensis* extract medium to the experimental setup using silicone tubing (6mm x 5mm), respectively. The use of 60ml BT syringes with Luer-Lock tip was to reduce cyanide volatilization in the system and for sampling purposes. The immersed MBRs and collection bottles and were constructed according to the schematic diagrams shown in Figs. 2 and 3, respectively.

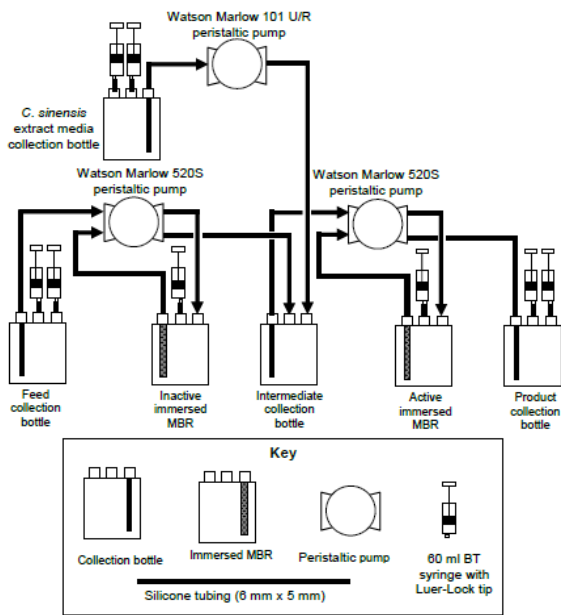

Fig. 1 Schematic representation of the dual stage MBR system designed

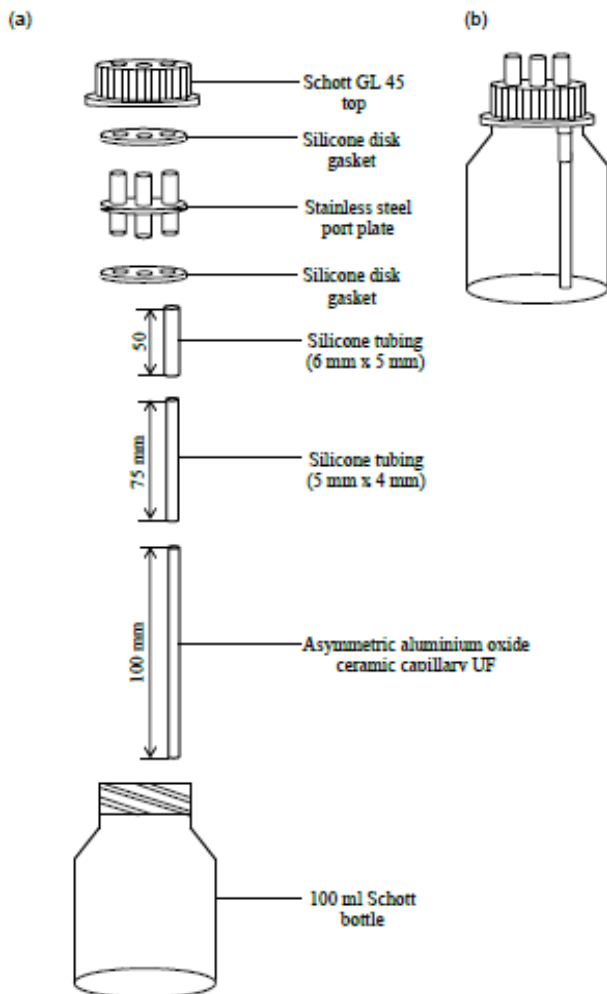

Fig. 2 (a) assembly and (b) the assembled MBRs

Asymmetric aluminum oxide ceramic capillary ultrafiltration (UF) membranes used in the construction of the MBRs were produced and supplied by Hyflux CEPAration BV (Netherlands) and have the specifications as shown in Table I [19]. The membranes were sealed with silicone rubber after sterilization to form a closed mode of membrane module operation.

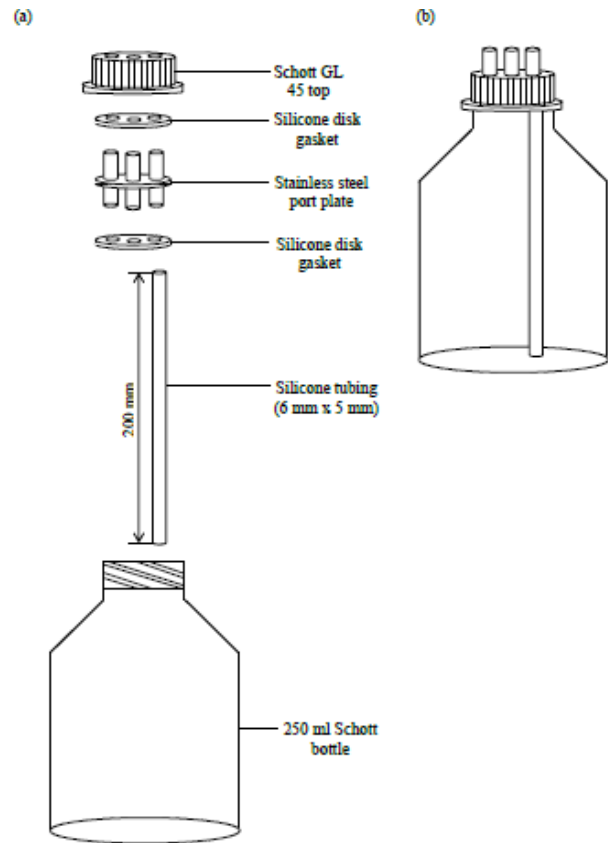

Fig. 3 (a) Assembly and (b) assembled collection bottles

TABLE I  
 ASYMMETRIC ALUMINUM OXIDE CAPILLARY OF MEMBRANE SPECIFICATIONS

Outer diameter (m)	0.0028
Inner diameter (m)	0.0018
Wall thickness (m)	0.0005
Burst pressure (Pa)	$5.0 \times 10^6$
Maximum temperature ( $^{\circ}\text{C}$ )	1000
Permeability (m/Pa.s)	$6.95 \times 10^{-10}$

#### F. Start-Up and Continuous Operation

The electroplating facility where the wastewater samples were collected is located in the Western Cape, South Africa, and its operations involve the plating of workpieces with Ni, Zn and/or Cu for decorative and protective purposes. The wastewater samples were collected from its municipal discharge point every 2 days during the experiments. An inoculum solution and 50ml *C. sinensis* pomace extract medium were added to the Active MBR and the solution was incubated at a temperature of  $40^{\circ}\text{C}$  and 150rpm for 48 hours. The 50ml inoculum solution was made by adding 0.5ml *C.*

*sinensis* pomace extract and 49.5ml sterile distilled water into a 100ml Schott bottle. After incubation, 100ml of the electroplating wastewater and 50ml of diluted electroplating wastewater were added to the MBRs, respectively. The diluted electroplating wastewater solution was made by adding 1ml electroplating wastewater and 49ml sterile distilled water to a 100ml Schott bottle. A mass of 11g hydrolyzed *C. sinensis* pomace, which was equivalent to 10g when dry, was added to the first stage of the MBR. The feed bottle was filled with the undiluted electroplating wastewater and the wastewater was pumped through the inactive part of the MBR at a rate of 10 ml/hour using a Watson Marlow 520S peristaltic pump for 24 hours. After 24 hours, the active MBR was started by pumping the intermediate wastewater to the Active MBR at 10 ml/hr using another Watson Marlow 520S peristaltic pump and supplying *C. sinensis* pomace extract from the hydrolysis of the pomace was added to the intermediate collection bottle at a rate of 0.001ml/hour using a Watson Marlow 101 U/R peristaltic pump. Samples from the feed, intermediate and product collection bottles were then withdrawn simultaneously at predetermined times for analysis every 24 hours. After sampling, the feed collection bottle was filled with collected electroplating wastewater and the product collection bottle was emptied. The electroplating wastewater collected from the electroplating facility was arranged and administered as feed to simulate fluctuating cyanide concentration and metallic species in order to assess the impact of fluctuations on the process.

After every 4 days of continuous operation, the hydrolyzed *C. sinensis* pomace was regenerated. The regeneration was performed by stopping the operation of the inactive part of the MBR, filtering and washing the *C. sinensis* pomace with 20 ml sterile distilled water in a Brüchner funnel with a No 1 Whatman filter paper under vacuum. The filter cake and 100 ml 0.1M HCl were then added to a 100ml Schott flask and incubated at 40°C and 150rpm for 2 hours to regenerate the pomace [20]. After 2 hours, the filter cake was rewashed with 20ml sterile distilled in a Brüchner funnel under vacuum. The filter cake was then added to the inactive MBR stage to restart another remediation cycle.

#### G. Analytical Methods

All samples were centrifuged at 13 000rpm using a Haraeus Megafuge 1.0 and filtered through a 0.22µm filter before analysis. The suspension in the deconstructed MBRs was first filtered through a pre-weighed filtered No 1 Whatman filter paper using a Brüchner funnel under vacuum/pressure and dried at 80°C for 24 hours to ascertain the dry mass of the biomaterial. The pH, temperature, TDS and conductivity were measured using an Oakton PCSTestr 35 Waterproof Multiparameter Tester calibrated using the respective standards every 24 hours. The Ni, Zn and Cu concentrations in the filtrate were analyzed using a Thermo iCap 6300 Inductively Coupled Plasma Atomic Emission Spectroscopy (ICP-AES). The instrument was calibrated using the National Institute of Standards and Technology (NIST) traceable

calibration standards from Merck, and the accuracy of results were verified using a separate NIST traceable standard. The total reduced sugar (TRS), metabolisable sugars and uronic acids, CHOO- and citric acid were quantified according to methods developed by the following references [21]-[25] using a Jenway 6715 UV/visible spectrophotometer. Merck cyanide (CN<sup>-</sup>) (09701) and Merck ammonium (N-NH<sub>4</sub><sup>+</sup>) (00683) test kits and colour (method code of 032) were used to quantify the [T-CN], [F-CN] and [WAD-CN], [NH<sub>4</sub><sup>+</sup>] and colour of the treated effluent using a NOVA 60 spectroquant.

### III. RESULTS AND DISCUSSION

#### A. Electroplating Wastewater Analysis

The average composition of the electroplating wastewater based on 20 samples taken every 2 days and other physico-chemical parameters as shown in Table II. According to the wastewater discharge standards, the electroplating wastewater was not suitable to be discharged into the municipal wastewater system [26].

The main factors evaluated were the cyanide and heavy metal concentrations (Ni, Zn, Cu) which also showed significant fluctuations in the wastewater as a function of time. This was directly related to the type of metals coating that was being performed during the time of sampling. However, upon further analysis, 96.5% of the T-CN being discharged was F-CN, 149.11 (± 9.31) mg F-CN/L and 5.25 (± 0.64) mg WAD CN/L, which makes this parameter importance due to its extreme toxicity including volatility, followed by the heavy metals.

TABLE II  
COMPARISON BETWEEN ELECTROPLATING WASTEWATER COMPOSITION USED IN THIS STUDY TO WASTEWATER DISCHARGE STANDARDS

Parameters	Wastewater discharge standards [26]	Electroplating wastewater
General		
Temperature	≥ 0 °C and ≤ 40 °C	22.50 (± 12.50) °C
pH value (25 °C)	≥ 5.5 and ≤ 12	10.46 (± 0.88)
Colour	Not indicated	8.61 (± 1.15) Pt-Co
Electrical conductivity (25 °C)	≤ 500 mS/m	145.73 (± 9.48) mS/m
Chemical substances		
Total dissolved solids (TDS)	≤ 4000 mg/L	998.83 (± 63.85) mg/L
Total cyanides as CN	≤ 20 mg/L	149.11 (± 50.75)
Total sugars as glucose	≤ 1500 mg/L	Not detected
Total ammonia as N	Not indicated	Not detected
Heavy metals		
Copper as Cu	≤ 20 mg/L	45.19 (± 25.89) mg/L
Zinc as Zn	≤ 30 mg/L	9.05 (± 5.26) mg/L
Nickel as Ni	≤ 5 mg/L	8.12 (± 4.78) mg/L

#### B. Continuous Membrane Bioreactor Process Operation

The T-CN, F-CN, WAD-CN, Cu, Ni and Zn concentrations were continuously quantified in the dual stage MBR system for 12 days electroplating wastewater containing different concentrations of T-CN, F-CN, WAD-CN, Cu, Ni and Zn for

the feed, intermediate and product streams are shown in Fig. 4.

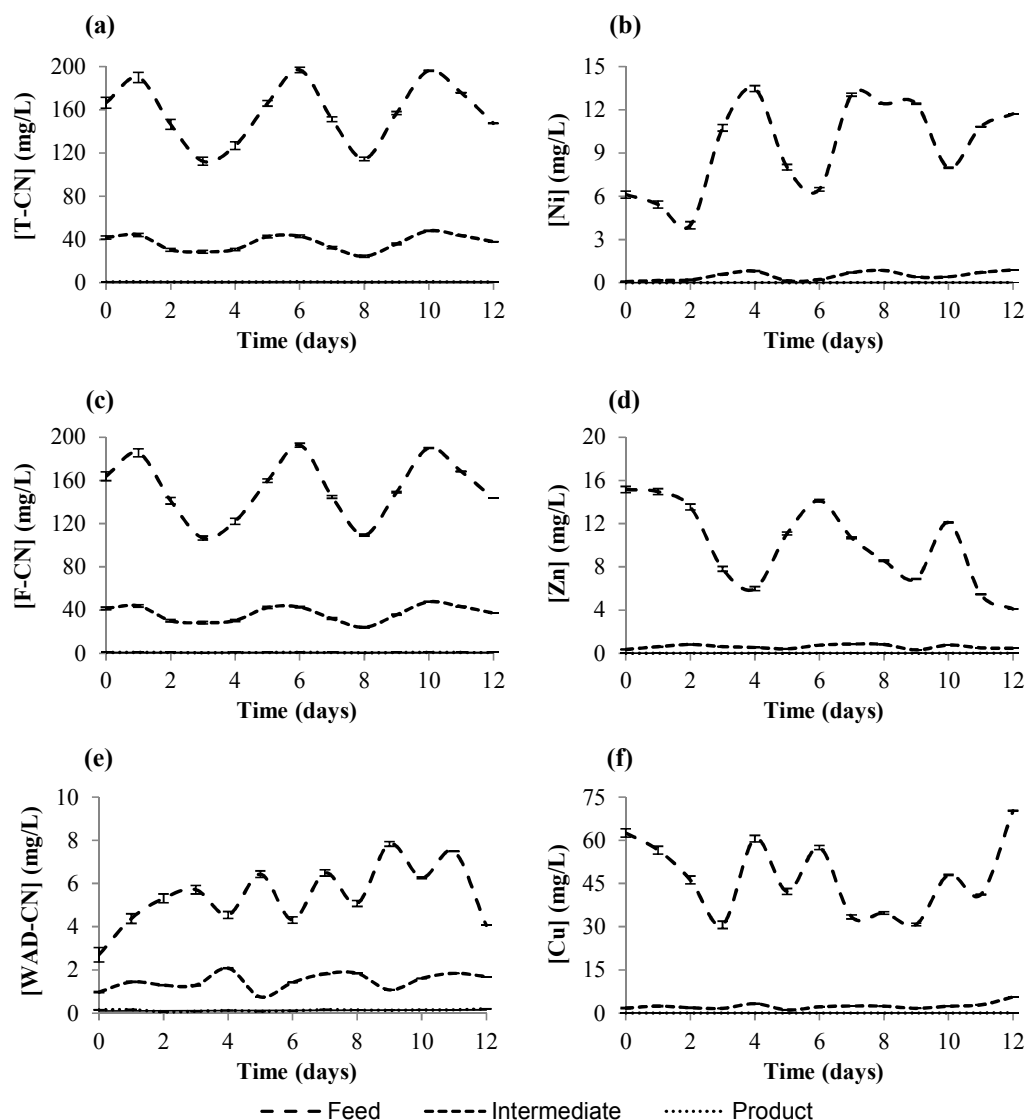

Fig. 4 (a) T-CN, (c) F-CN; (e) WAD-CN, (b) Ni, (d) Zn and (f) Cu concentrations in feed, intermediate and product streams

TABLE III  
AVERAGED TREATMENT EFFICIENCY FOR CYANIDES AND HEAVY METALS  
USING THE DUAL STAGE MBR PROCESS DESIGNED

Contaminate	Average treatment efficiency (%)	
	After first treatment stage	After second treatment stage
T-CN	76.37	99.55
F-CN	75.80	98.06
WAD-CN	65.16	90.67
Ni	93.26	99.92
Zn	94.76	99.92
Cu	95.37	99.91

However, there was a reduction of 85.48%, 45.11%, 47.86% and 49.93% in the fluctuations for T-CN, Ni, Zn and Cu after the first treatment stage which could have negatively affected the treatment efficiency of the second treatment stage. The averaged treatment efficiencies for these variables over

the 12 days of operation are as shown in Table III.

However, an average of 10.64% and 7.39% higher treatment efficiency was achieved for F-CN than WAD-CN for the first and second treatment stage, respectively. This was due to the combined inhibiting effects of the heavy metals which affected the biodegradation of WAD-CN significantly than F-CN. Although, the presence of heavy metals inhibited the catalytic conversion of F-CN, this phenomenon can be controlled by the acid regeneration of the *C. sinensis* pomace [27]. The generation of the hydrolyzed *C. sinensis* pomace was performed every 4 days, with an approximately loss of 0.25% of hydrolyzed *C. sinensis* pomace due to the acid regeneration process. The percentage recovered of Cu, Ni and Zn from the pomace, is shown in Table IV. The insignificant change in the recovery efficiency of the heavy metals from the hydrolyzed *C. sinensis* pomace and the evident pseudo-catalytic degradation

of the cyanide after the regeneration of the hydrolysed *C. sinensis* pomace highlighted the potential of its reusability for the remediation of cyanides and heavy metals, respectively, on a large scale.

TABLE IV  
Ni, Zn AND CU RECOVERY FROM THE REGENERATION OF HYDROLYZED *C. SINENSIS* POMACE

Regenerati on cycle	Recovery (%)		
	Cu	Ni	Zn
1	99.04	99.13	99.12
2	98.41	98.94	98.92
3	97.91	98.46	98.44

Similarly, during the second treatment stage metabolized cyanide conversion by-products was 99.81% and 99.75 for  $\text{CHOO}^-$  and  $\text{NH}_4^+$ , respectively, despite significant concentration fluctuations in these by-products in the intermediate stream, as shown in Fig. 5. The concentration of these contaminants and by-products in the product stream were at levels permissible for municipal discharge.

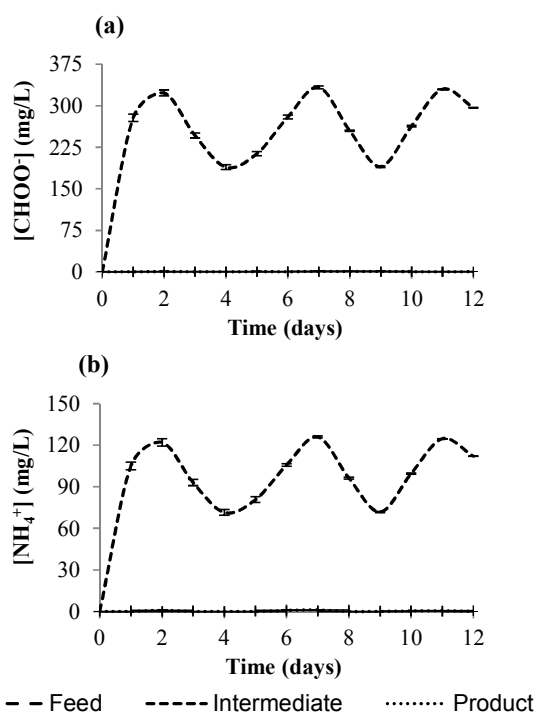

Fig. 5 (a)  $\text{CHOO}^-$  and (b)  $\text{NH}_4^+$  concentrations in intermediate and product streams

The TRS concentration, comprising of uronic acid and neutral sugars, in the intermediate stream to supplement the second treatment stage exhibited a declining trend for the first 4 days of continuous operation, after which the trend plateaued, as shown in Fig. 6.

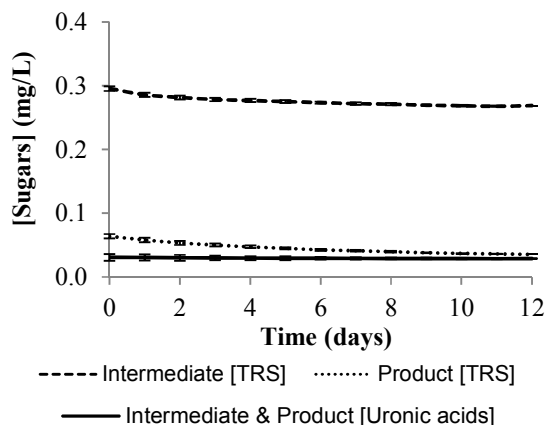

Fig. 6 Sugar concentrations in intermediate and product streams

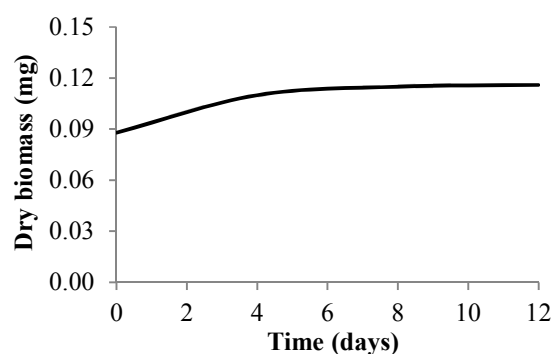

Fig. 7 Dry biomass development in second treatment stage of the MBRs

Minimal residual quantities of TRS were transferred into the wastewater from the hydrolyzed *C. sinensis* pomace in the first treatment stage into the second treatment stage. However, the uronic acid concentration remained relatively constant throughout the continuous operation with neutral sugars being the only metabolisable carbon source in the *C. sinensis* pomace supplied in the intermediate stream to maintain the *A. awamori* used in the second treatment stage. After 9 days of continuous operation, the TRS concentration in the product stream exhibited an asymptotic trend towards the uronic acid trend profile which was due to the near complete metabolism of the neutral sugars. Similarly, there was negligible quantifiable citric acid in the fermented broth detected which was attributed to the low carbon source supplementation of the cultures [12]. The residual quantities of TRS in the product stream do not pose any environmental hazards. The metabolism of the neutral sugars and biomass development exhibited an exponential decline as the fungus was adapting to the continuous operational mode of the system, as shown in Figs. 6 and 7. Similarly, the observed low supplement requirements of the fungus using the *C. sinensis* pomace extract has shown that the designed system can be used as an effective bioreactor system on a large scale. The pH, conductivity, TDS and color of the water were analyzed to assess the reusability of the water since these parameters do

affect the reusability of the treated water, as shown in Fig. 8. The color of the wastewater has shown to be problematic since it significantly increased after each treatment stage which was due to the transfer of pigments from the hydrolyzed *C. sinensis*

pomace to the wastewater. The alkaline pH of the waster also results in an increase in colorant transfer to the liquid phase due to the chemical modification of these pigments resulting in the production of a liquid with luminescent color.

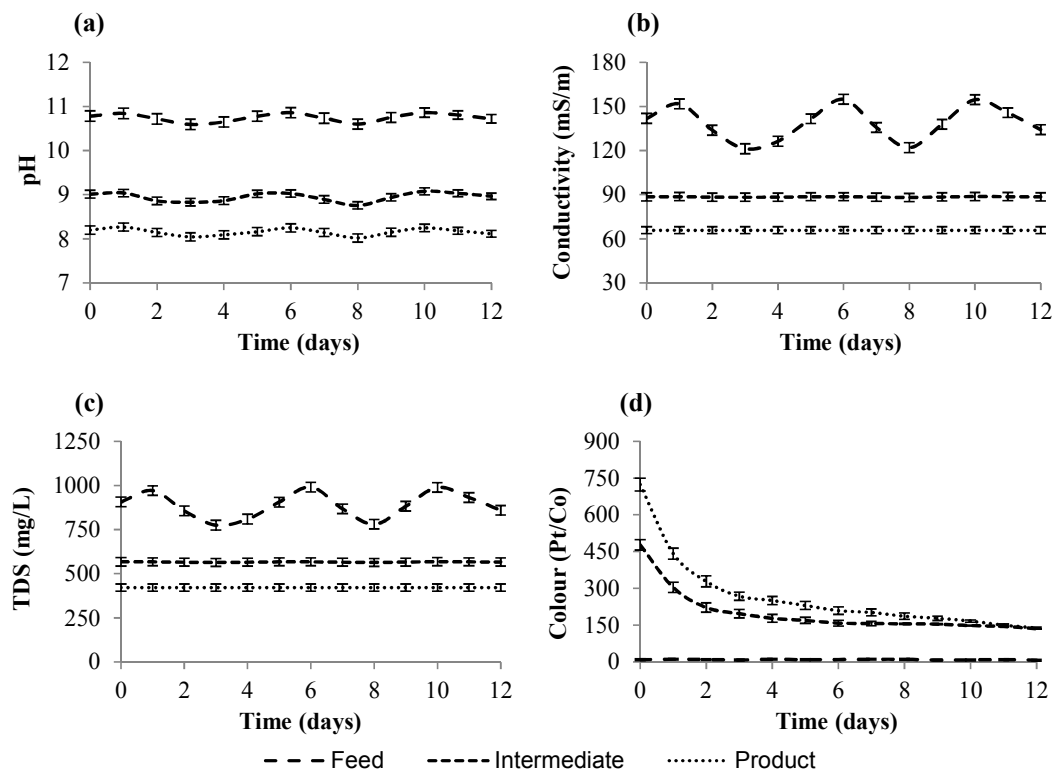

Fig. 8 (a) pH, (b) conductivity, (c) TDS and (d) color of intermediate and product streams

However, there was a decline in color when the MBR systems were operated for longer periods due to the dilution of the MBR contents by incoming wastewater into the system. Since pH, conductivity and TDS are interrelated, as they are influenced by the species present in the wastewater, their reduction in the water contaminants resulted in a reduction in these parameters.

#### IV. CONCLUSION

The designed two stage immersed MBR treatment highlighted the potential of using environmentally friendly and sustainable processes for the combined treatment of cyanides and heavy metals contaminated wastewater. Similarly, the potential of using agricultural residues as treatment biomaterials and nutrient source to supplement an active microbial bioreactor was demonstrated. This incorporates unique treatment abilities and metabolic characteristics not previously possible and is more cost effective compared to conventional treatment methods. Furthermore, the design showed to be robust and reduce fluctuations of cyanide and heavy metal contaminants using the first treatment stage to facilitate the metabolism and removal of contaminants in the electroplating wastewater on a constant basis. However, the design only managed to treat the wastewater for safe discharge

standards and the use of a tertiary treatment stage, such as reverse osmosis, to remove the remaining trace contaminants and colorants from the product water will ensure that the water will meet quality guidelines for potable water standards thus the reusable as process water. Furthermore, the removal of heavy metal inhibited the pseudo-catalytic conversion of the cyanide during the first treatment stage, which showed to be successfully controlled by the acid regeneration to reactivate the pseudo-catalytic potential of the hydrolyzed *C. sinensis* pomace. Overall, there was relatively insignificant standard deviation detected in all the measured parameters in the continuous operation which indicated the strong reproducibility in the treatment efficiency in this continuous system.

#### REFERENCES

- [1] G. C. Cushnie and CAI Resources, Inc. Pollution Prevention and Control Technologies for Plating Operations. 2nd ed. Ann Arbor: NCMS, Inc., 2009, ch. 5.4.
- [2] A. B. Nesbitt, Recovery of Metal Cyanides Using a Fluidized Bed of Resin. Cape Town: Cape Tech., 1996.
- [3] E. B. Nsimba, Cyanide and Cyanide Complexes in the Goldmine Polluted Land in the East and Central Rand Goldfields, South Africa. Johannesburg: WITS, 2009.
- [4] J. Wang and C. Chen, "Biosorbents for Heavy Metals Removed and their Future," *Biotechnol. Adv.*, vol. 27, no. 2, pp. 195-226, Dec. 2009.

- [5] D. Sud, G. Mahajan and M. P. Kaur, "Agricultural Waste Material as Potential Adsorbent for Sequestering Heavy Metal Ions from Aqueous Solutions - A Review," *Bioresour. Technol.*, vol. 99, no. 14, pp. 6017-6027, Feb. 2008.
- [6] N. Gupta, C. Balomajumder and V. K. Agarwal, "Enzymatic Mechanism and Biochemistry for Cyanide Degradation: A Review," *J. hazard. Mater.*, vol. 176, no. 1-3, pp. 1-13, Nov. 2010.
- [7] M. A. Rao, R. Scelza, R. Scotti and L. Gianfreda, "Role of Enzymes in the Remediation of Polluted Environments," *J. Soil Sci. Plant Nutr.*, vol. 10, no. 3, pp. 333-353, Jul. 2010.
- [8] X. Li, Y. Tang, X. Cao, D. Lu, L. Fang and W. Shao, "Preparation and Evaluation of Orange Peel Cellulose Adsorbents for Effective Removal of Cadmium, Zinc, Cobalt and Nickel," *Colloids and Surf. A*, vol. 317, no. 1-3, pp. 512-521, Mar. 2008.
- [9] A. Jarrell, "Researchers Propose an 'Appealing' Solution for Juicing's Leftovers," *Inside Science*, 06 Jul. 2012.
- [10] K. Grohmann, R. G. Cameron and B. S. Buslig, "Fractionation and Pretreatment of Orange Peel by Dilute Acid Hydrolysis," *Bioresour. Technol.*, vol. 54, no. 2, pp. 129-141, Jul. 1995.
- [11] D.A. Mitchell, N. Krieger and M. Berovic, *Solid-state Fermentation Bioreactors: Fundamentals of Design and Operation*. Berlin: Springer, 2006, ch. 1.
- [12] M. Papagianni, "Advances in Citric Acid Fermentation by *Aspergillus niger*: Biochemical Aspects, Membrane Transport and Modeling," *Biotechnol. Adv.*, vol. 25, no. 3, pp. 244-263, Jan. 2007.
- [13] B. Godongwana. *Momentum Transfer inside a Single Fibre Capillary Membrane Bioreactor*. Cape Town: CPUT, 2007.
- [14] H. S. Fogler. *Elements of Chemical Reaction Engineering*. 4th ed. New Jersey: Person Education International, 2006, pp. 207-215.
- [15] B. A. Q. Santos, S. K. O. Ntwampe and J. H. Doughari. "Continuous Biotechnological Treatment of Cyanide Contaminated Waters by using a Cyanide Resistant Species of *Aspergillus awamori*," in *Environmental Biotechnology – New Approaches and Prospective Applications*, M. Petre, Ed. Croatia: InTech, 2013, pp. 123-146.
- [16] J. Varga, J. C. Frisvad, S. Kocsubé, B. Brankovics, B. Tóth, G. Szigeti and R. A. Samson, "New and Revisited Species in *Aspergillus* Section *Nigri*," *Studies in Mycology*, vol. 69, no. 1, pp. 1-17, Jun. 2011.
- [17] A. M. Torrado, S. Cortés, J. M. Salgado, B. Max, N. Rodríguez, B. P. Bibbins, A. Converti and J. M. Domínguez, "Citric Acid Production from Orange Peel Waste by Solid-state Fermentation," *Braz. J. Microbiol.*, vol. 42, no. 1, pp. 394-409, 2011.
- [18] F. Talebnia, M. Pourbafrani, M. Lundin, M. and M. J. Taherzadeh, "Optimisation Study of Citrus Wastes Saccharification by Dilute-acid Hydrolysis," *BioResource*, vol. 3, no. 1, pp. 108-122, Mar. 2008.
- [19] D. de Jager, *Streptomyces coelicolor* Biofilm Growth Kinetics and Oxygen Mass Transfer within a Membrane Gradostat Bioreactor. Cape Town: CPUT, 2010.
- [20] A. M. Awwad and N. M. Salem, N.M. 2012. "Biosorption of Copper (II) and Lead (II) Ions from Aqueous Solutions by Modified Loquat (*Eriobotrya japonica*) Leaves (MLL)," *J. Chem. Eng. Mater. Sci.*, vol. 3, no. 1, pp. 7-17, Feb. 2012.
- [21] G. L. Miller, "Use of Dinitrosalicylic Acid Reagent for Determination of Reducing Sugars," *Anal. Chem.*, vol. 31, no. 3, pp. 426-428, Mar. 1959
- [22] T. M. C. C. Filisetti-Cozzi, and N. C. Carpita, "Measurement of Uronic Acids without Interference from Neutral Sugars," *Anal. Biochem.*, vol. 197, no. 1, pp. 157-162, Feb. 1991.
- [23] K. A. Taylor and J. G. Buchanan-Smith, "A Colorimetric Method for the Quantification of Uronic Acids and Specific Assay for Galacturonic Acid," *Anal. Biochem.*, vol. 201, no. 1, pp. 190-196, Nov. 1992
- [24] R. Sleat and R. A. Mah, "Quantitative Method for Colorimetric Determination of Formate in Fermentation Media," *Applied and Environmental Microbiology*, vol. 47, no. 4, pp. 884-885, Apr. 1984.
- [25] J. R. Marier and M. Boulet, "Direct Determination of Citric Acid in Milk with an Improved Pyridine-acetic Anhydride Method," *J. Dairy Sci.*, vol. 41, no. 12, pp. 1683-1692, Apr. Jun. 1958.
- [26] South Africa, "City of Cape Town: Wastewater and Industrial Effluent By-law," *Province of Western Cape Provincial Gazette*, 6378(18366): 1558-1577, 01 Sep. 2006.
- [27] B. A. Q. Santos, S. K. O. Ntwampe, J. H. Doughari and G. Muchatibaya. 2013. "Application of Citrus *sinensis* Solid Waste as a Pseudo-catalyst for Free Cyanide Conversion under Alkaline Conditions," *Bioresour.* vol. 8, no. 3, pp. 3461-3467, Jul. 2013.