

Preliminary Development of a Hydrogen Peroxide Thruster

Y. A. Chan, H. J. Liu, K. C. Tseng, and T. C. Kuo

Abstract—Green propellants used for satellite-level propulsion system become attractive in recent years because the non-toxicity and lower requirements of safety protection. One of the green propellants, high-concentration hydrogen peroxide H_2O_2 solution ($\geq 70\%$ w/w, weight concentration percentage), often known as high-test peroxide (HTP), is considered because it is ITAR-free, easy to manufacture and the operating temperature is lower than traditional monopropellant propulsion. To establish satellite propulsion technology, the National Space Organization (NSPO) in Taiwan has initialized a long-term cooperation project with the National Cheng Kung University to develop compatible tank and thruster. An experimental propulsion payload has been allocated for the future self-reliant satellite to perform orbit transfer and maintenance operations. In the present research, an 1-Newton thruster prototype is designed and the thrusting force is measured by a pendulum-type platform. The preliminary hot-firing test at ambient environment showed the generated thrust and the specific impulse are about 0.7 Newton and 102 seconds, respectively.

Keywords—Hydrogen peroxide, propulsion, RCS, satellite.

I. INTRODUCTION

SATELLITE-LEVEL propulsion system, usually mentioned as reaction control system (RCS hereafter), is used to provide operations of orbit correction, orbit transfer and orbit maintenance [1]. There are several types of propulsion systems used on launchers and space satellites [2]-[4]. Solid-based propulsion systems are usually used for a launch's booster to lift off. It provides higher thrust but is limited in flexibility. The gas propulsion system is extremely simple, reliable, and low cost solution; however, its efficiency is relative poor and it requires strong structure and large volume to sustain a high pressure environment. Electric propulsion systems provide thrusting force by accelerating ions of plasma, offering low levels of thrust. However, these systems with higher specific impulses are usually reserved for interplanetary travel.

Liquid propulsion systems usually generate force by homogenous or heterogeneous chemical reactions. It can be categorized into three main types: monopropellant, bipropellant, and cryogenic systems. Monopropellant systems use a single chemical; most famous one is hydrazine, decomposed by specific catalyst bed to produce desired thrust. Bipropellant systems use a liquid fuel and an oxidizer, such as hydrogen and

oxygen, injected into a chamber separately to generate thrust by chemical combustion. Cryogenic systems mean the fuel and/or oxidizer stored at extremely low temperature. The propellant cost is low and it can provide very high specific impulse (up to 450 s). But the storage preventing heat loss, leakage, and transferring in space are challenged. Such liquid propulsion systems have higher specific impulse but the configurations are relatively complicated. The most important of all, propellants used in liquid propulsions are usually toxic and carcinogenic, requiring specialized on-ground safety facilities for storage and processing.

In recent year, green (low-toxic) monopropellants become another option for traditional hydrazine-based fuel. The main advantages of these alternative propellants are: the significant cost saving associated with the facilities; lower cost for materials; easy to produce, handling, and storage; no ITAR policy; and good for environment. One of these green propellants is hydrogen peroxide.

Hydrogen peroxide is a common chemical used widely in many applications in the world. Most applications are in pulp- and paper-bleaching industries, food and chemical processing, and wastewater treatment. High-concentration hydrogen peroxide solution is a strong oxidizer and can be used as a monopropellant. The first research of hydrogen peroxide for propellant application is proposed by Walter in 1935 [5]. He used 80% hydrogen peroxide to start submarine turbine drive systems and assisted take-off units with liquid injection of permanganate catalyst. In the post-WWII years up to 1990s, the United Kingdom and the United States have developed hydrogen peroxide in aircraft rocket engine and civilian space exploration [6], [7]. A heavily utilized of hydrogen peroxide was onboard satellite thruster. It was one of most potential chemicals that could be used as a monopropellant. Jack et al. at the Langley Research Center in the United States investigated a series of catalyst beds for hydrogen peroxide thruster [8]. Unfortunately, the development of hydrogen peroxide does not turn out to be thriving for some reasons. Firstly, it was replaced by hydrazine when the catalyst Shell 405 was invented [9]. Secondly, Clark's comments to hydrogen peroxide associated with detonation hazards, stability in storage, difficulties with ignition and undesirable high freezing point [10]. These inappropriate criticisms might hesitate to use hydrogen peroxide as a monopropellant.

In the last decade, HTP has been reevaluated as a green propellant for applications of power and propulsion because it is ITAR-free and environment-friendly. Wernimont and Mullens at General Kinetics have developed several catalyst beds (silver

Y. A. Chan, H. J. Liu, and K.C. Tseng are propulsion engineers at the National Space Organization, Taiwan (e-mail: yachan@narlabs.org.tw, hank.liu@narlabs.narl.org.tw, kctseng@narlabs.narl.org.tw).

T. C. Kuo is propulsion manager at the National Space Organization, Taiwan (e-mail: tckuo@narlabs.narl.org.tw).

screen type) for 70 to 92% hydrogen peroxide [11]. Experimental test of three different thrust levels, which are 3 lbf, 6 lbf, and 25 lbf, have been conducted and results showed the thruster minimum life was over 300 seconds.

Darren et al. tried to apply Microelectromechanical systems (MEMS) techniques to develop micro-Newtons hydrogen peroxide monopropellant thrusters and several engineering challenges were encountered [12]. James at Aerojet proposed using monolithic silver coated catalyst beds for 90% hydrogen peroxide can improve system performance, weight, and cost [13]. The catalyst life of over 900 seconds has been demonstrated. Austrian Research Centers (ARC) in Austria initiated a contract with European Space Agency (ESA) to develop hydrogen peroxide systems for microsatellites uses [14]. Measurements on a thrust balance has shown that the thruster can generate thrust between 150 and 170mN with a specific impulse of 153 s. Alta S.p.A. (Italy) and DELTACAT Ltd. (United Kingdom) were also funding by ESA to perform a series research about the hydrogen peroxide monopropellant thruster [15]. The objective of the activity is the design and realization of two prototype thrusters (a 5N and a 25N). Authors found that Pt/Al₂O₃ is an effective catalyst combination with good stability and performance comparable to silver screen beds. However, it was found that the catalyst beds have rupture situation, low characteristic velocity and temperature efficiencies, high pressure drop and flow instabilities across the catalyst bed. Lee adopted a dual catalyst bed with two different sections, silver screens and stainless steel screens or monolithic catalyst [16]. The efficiency of characteristic velocity, pressure drop at catalyst and hydrogen peroxide concentration and mass flow rate were also shown in his research.

To satisfy the future mission, the goal of this research is to develop a hydrogen peroxide propulsion system with effective, reliable and repeatable thruster which can sustain long hot-firing operation. Linear blow-down operating performance in a wide pressure range is also required in the future.

II. CATALYST AND THRUSTER DESIGN

A. System Requirements and Specifications

The primary mission of the future NSPO-Built satellite, named NB satellite, is to launch and verify a NSPO-developed small satellite platform on a specific orbit. Several components and subsystems will be accommodated for the mission and performed the verifications. One of these is a RCS demonstration module (RCS-DM) integrated to the satellite bus for conducting orbit transfer operations. The system requirements for the RCS-DM are listed in the following:

- The total mass, including loaded propellant, shall not be over 7.0kg,
- Space envelope shall within 30cm × 30cm × 20cm,
- Thrusting force shall be 1N,
- Green propellant is necessary for cost and safety issue.

To satisfy these system requirements, the trade study was performed and 90% hydrogen peroxide monopropellant was selected for 1-N grade propulsion system. Fig. 1 shows the

RCS-DM configuration for the NB satellite. It consists one diaphragm tank for H₂O₂ propellant storage, one fill venting valve (FVV) and fill drain valve (FDV) for loading and venting/draining pressurant and propellant, respectively, one pressure transducer (PT) for pressure monitoring, one filter for preventing particle contamination, one latch valve (LV) for flow isolation, and two branches equipped with thruster assembly (including thruster valve, catalyst bed and nozzle) for providing 1N thrust. A thermal control system is also required to provide temperature monitoring, control, and catalyst bed preheating. Due to the mass and space limitation, the RCS-DM is designed as 1.0L capacity, which can load about 1.4kg hydrogen peroxide monopropellant, to give a ΔV of 6.8m/s orbit transfer for 300kg satellite. In this research, a 1N thruster with a ceramic material loaded with silver in the reaction chamber was fabricated and tested.

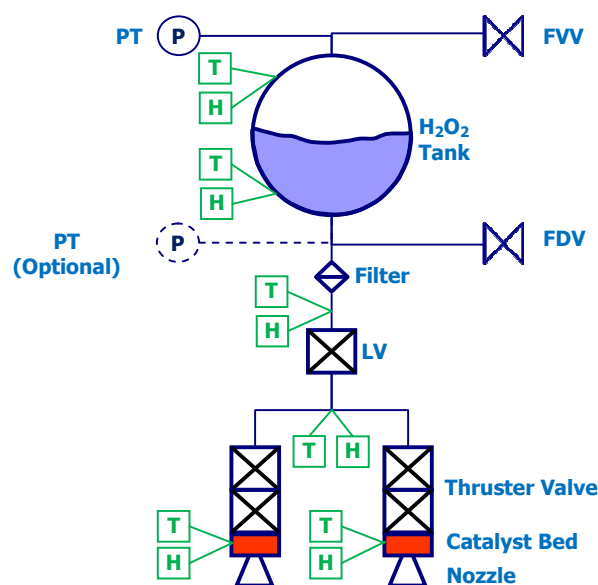

Fig. 1 The RCS-DM configuration for the NB satellite

B. Catalyst

In this paper, we choose silver as the main ingredients for H₂O₂ catalyst because of its higher reactivity than other catalyst material [17]. However, the primary challenge for the silver-based catalyst is the ability to resist the heat released from the decomposition processes, which will lead to the decay of catalyst we call sintering effect. This effect not only extremely reduces the reactive area of catalyst, but also induces serious fluid dynamics instability during the thruster operation [15].

In 2011, the combustion lab in the National Cheng Kung University proposed a newly type of catalysis named composite silver catalyst [18], which has designed to provide the highly active feature with H₂O₂ propellant as well as overcome the defect of silver/stainless steel meshes. Fig. 2 illustrates the diagram of composite silver catalyst bed. The concept of the composite silver catalyst bed is to increase the thermo-resistance of the catalyst indirectly by inserting ceramic material between silver pellets. These ceramic materials could

perform as heat reservoir to absorb abundant heat released from H_2O_2 decomposition processes, which could provide additional space for H_2O_2 propellant to induce thermal self-decomposition by its own decomposition-heat releaser. On the other hand, these ceramic materials could also provide the function as a catcher to prevent or reduce the loss rate of silver that could extend the life duration of the catalyst bed. By appropriate disposition, this catalyst bed could provide the extraordinary life duration and pressure build-up performance.

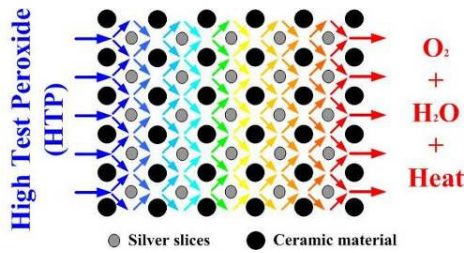

Fig. 2 Design concept of composite silver catalyst bed

C. Thruster

To obtain the design parameters, numerous assumptions, such as ideal gases, isentropic flow, fully decomposition of H_2O_2 propellant, and chemical equilibrium, are made. The designed thrust at sea level and chamber absolute pressure are 0.85 N and 150 psi, respectively. 90% HTP is chosen in developing phase for the thruster for long-term life duration. Equations (1)~(5) are used to obtain ideal values of the thruster. Table I lists the parameters settings of the thruster.

$$C^* = \sqrt{\frac{1}{\gamma} \left(\frac{\gamma+1}{2} \right)^{\frac{\gamma+1}{\gamma-1}} RT_c} \quad (1)$$

$$\dot{m} = A_t P_c \sqrt{\left(\frac{2}{\gamma+1} \right)^{\frac{\gamma+1}{\gamma-1}} \frac{\gamma}{RT_c}} \quad (2)$$

$$C_F = \sqrt{\left(\frac{2\gamma^2}{\gamma-1} \right) \left(\frac{2}{\gamma+1} \right)^{\frac{\gamma+1}{\gamma-1}} \left[1 - \left(\frac{P_e}{P_c} \right)^{\frac{\gamma+1}{\gamma}} \right] + \frac{P_e - P_a}{P_c} \frac{A_e}{A_t}} \quad (3)$$

$$F = \dot{m} \times C^* \times C_F \quad (4)$$

$$I_{sp} = \frac{F}{\dot{m}g} \quad (5)$$

Fig. 3 shows thruster parts, which are injector, injection plate, chamber, distribution plate, thermal couple (TC) and pressure transducer (PT) section, and nozzle. All these parts were manufactured from SS 304L except o-rings, which were made of brass. Between each parts, the flanges design with brass o-ring was used to keep thruster from leaking.

Design Parameters		
H_2O_2	Hydrogen peroxide propellant	90 %
F	Thrust	0.85 N
P_c	Chamber pressure	150 Psi
P_a	Ambient pressure	14.6 Psi
α	Divergent angle	15 Degree
γ	Specific heat ratio	1.2632
A_e / A_t	Exit to throat area ratio	2.1642
C_F	Thrust coefficient	1.2592
C^*	Characteristic velocity	958.39 m/s
D_t	Throat diameter	0.91 mm
g	Gravity constant	9.81 m/s ²
I_{sp}	Specific impulse	123.01 s
L	Divergent length	0.8 mm
\square	Mass flow rate	0.7018 g/s
P_e	Exit pressure	21.2 Psi
R	Specific gas constant	0.3763 kJ/K . kg
T_c	Chamber temperature	791.9 °C
u_e	Exit velocity	1216.2 m/s

Catalyst bed was packed inside the chamber and fixed between injection plate and distribution plate. Injection plate and distribution plate were designed for distributing liquid H_2O_2 and decomposed water vapor and oxygen uniformly, respectively. Considering the precision of the thruster, injection plate was manufactured by electro discharge machining and inspected under microscope.

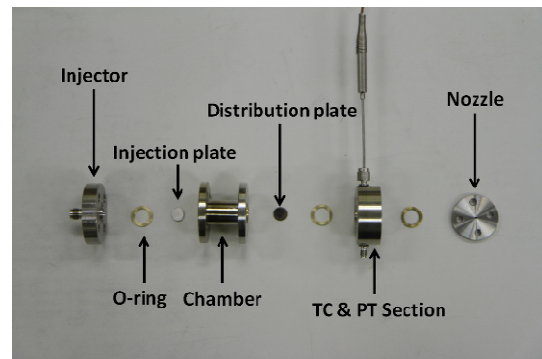

Fig. 3 Main parts of the H_2O_2 thruster

III. EXPERIMENTAL SETUP

A. Thrust Measurement System

Fig. 4 presents the simplification of thrust measurement system. The whole system could be separated to three sub-systems, pressuring and purging system, H_2O_2 filling system, and thrust test platform. There are several solenoid valves and manual valves used to control and regulate the system, which are not shown in this figure due to complexity. Three PTs are installed to monitor pressures at tank, thruster inlet, and catalyst bed downstream. Also, there is one load cell and one thermal couple to measure the thrust force and chamber temperature during test, respectively.

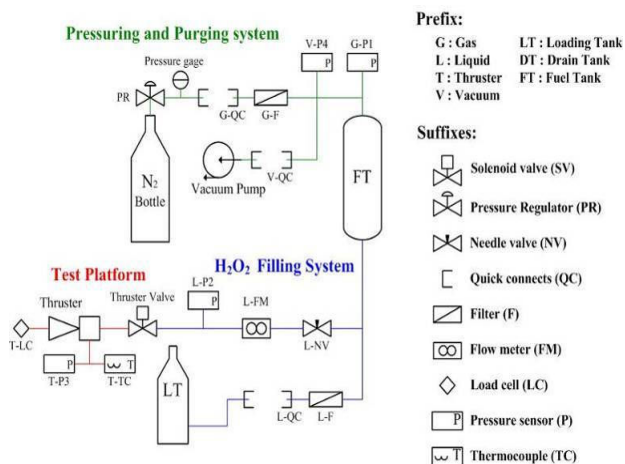
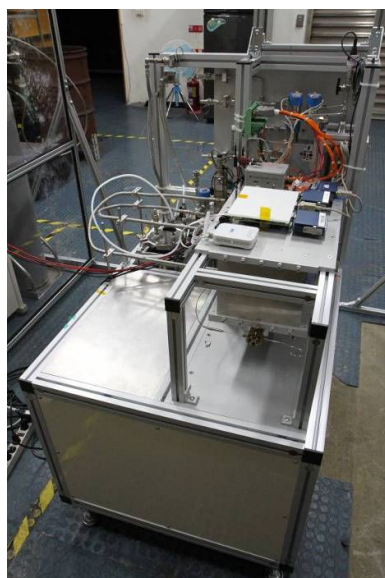
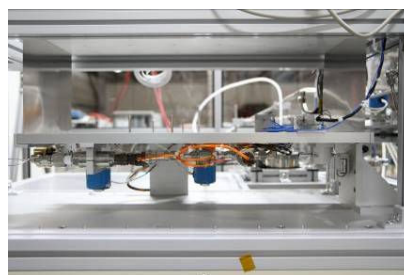

Fig. 4 Simplified piping diagram for the H₂O₂ propulsion system

Fig. 5 shows the photos of the system, thrust test platform, and the arrangement of the thruster, solenoid valves, PTs, and TC, etc. The main structure of the system are manufactured by clear anodized aluminum, pipe system is assembled from stainless steel 316 with cleaning and passivation processes. The test platform is designed in pendulum-type to provide enough flexibility for measuring thrusting force. The propellant filling system between the test platform and fuel tank were connected by flexible pipe in perpendicular direction in order to minimize the force influence. For the precision thrust force measurement, the moving direction of the magnetic plug in solenoid valve is vertical to the load cell sensing direction that could eliminate the force fluctuation when the valve is opened.



(a)



(b)



(c)

Fig. 5 (a) Thruster measurement system, (b) thruster test platform, (c) thruster assembly

B. Real-Time Data Acquisition and Control System

The electrical components used in the proposed thruster test platform consists pressure transducers, mass flow meter, load cell, thermocouples, and solenoid valve. In order to acquire the pressure, propellant (H₂O₂) mass flow rate, temperature and thrust force of the system in a sampling rate of 100 Hz as well as control the thruster solenoid valve in pulse mode in the future, a real-time data acquisition and control system (DACS) was built based on a graphical programming environment, LabVIEW, and an embedded real-time controller, sbRIO-9631, as shown in Fig. 6. Because sbRIO-9631 only equipped with the I/O modules of Analog Input/Output and Digital Input/Output, the thermocouple module (NI 9211) and relay module (NI 9485) are integrated into the system. Table II is the specifications of the established DACS, whose maximum sampling rate is 100 Hz and the minimum pulse width for controlling the open time of the solenoid valve is 30ms.



Fig. 6 DACS block diagram and hardware

TABLE II
 SPECIFICATIONS OF THE DACS

DACS	Specifications
Embedded Real-Time Controller (sbRIO-9631)	<ul style="list-style-type: none"> ● 266 MHz processor, 128 MB nonvolatile storage, 64 MB DRAM for deterministic control and analysis ● Embedded Device with AI, AO, DIO, 1M gate reconfigurable I/O (RIO) FPGA ● 110 3.3 V (TTL/5 V tolerant) DIO lines, 32 16-bit analog inputs, four 16-bit analog outputs ● 10/100BASE-T Ethernet port and RS232 serial port, 19 to 30 Vdc supply input ● -20 to 55 °C operating temperature range ● 4 thermocouple or ±80 mV analog inputs
Thermocouple Module (NI 9211)	<ul style="list-style-type: none"> ● 24-bit resolution; 50/60 Hz noise rejection ● -40 to 70 °C operating range ● Works over temperature ranges defined by NIST (J, K, T, E, N, B, R, S thermocouple types) ● 8 solid-state relay (SSR) outputs
Relay Module (NI 9485)	<ul style="list-style-type: none"> ● 60 VDC, 30 Vrms switching voltage ● Switching current of 1.2 A/channel for up to 4 channels; 750 mA/channel for all channels

IV. PRELIMINARY TEST RESULTS AND DISCUSSIONS

Before conducting the hot-firing test of the H₂O₂ RCS thruster, pre-test measurements have to be performed to ensure the test integrity. First of all is the thruster dimension measurement. Fig. 7 shows the microscopic view of the nozzle throat from the convergent side. As you can see the contour of the throat is a little zigzag that the impact to thrust measurement should be evaluated or improved in the future; however, the measured throat diameter is about 0.912mm in average and the variation is within 1.5%.

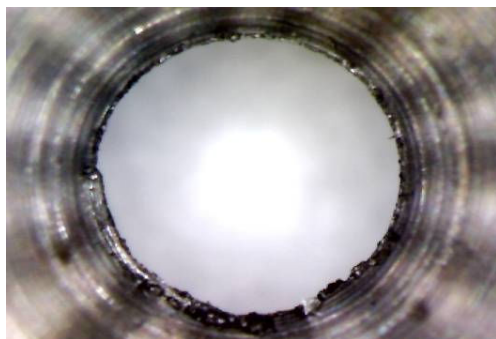

Fig. 7 The nozzle throat of the H₂O₂ thruster before hot-firing test

Leakage check should be conducted by a Helium gas detector or snoopers when the thruster is assembled. After installation of thruster assembly, the thruster test platform is balanced by a horizontal level. Then the thrust calibration procedure by using standard weights is conducted to obtain the system calibration curve. In the following hot-firing test, 90% hydrogen peroxide propellant is used and checked by measuring its density and conductivity.

A. Test Case 1

Figs. 8 (a) and (b) show one of thruster test results of inappropriate packing of the composite silver catalyst bed. In this test, thruster is preheated then fired about 250 s. Total firing time of this thruster is about 1,750 s; however, the chamber

pressure is extremely unstable and the chamber temperature is built up to 530°C only, which is far from the theoretical adiabatic temperature of 90% H₂O₂ propellant. To evaluate the catalyst bed, the characteristic exhaust velocity efficiency η_{C^*} , which is defined as the ratio of experimental value to the theoretical value, is obtained and shown in Fig. 8 (b). As you can see it has significant fluctuation because the reaction is unstable and the mean value is around 70% only. After test, the thruster was disassembled and we can see the catalyst bed has serious sintering effect which is shown in Fig. 9.

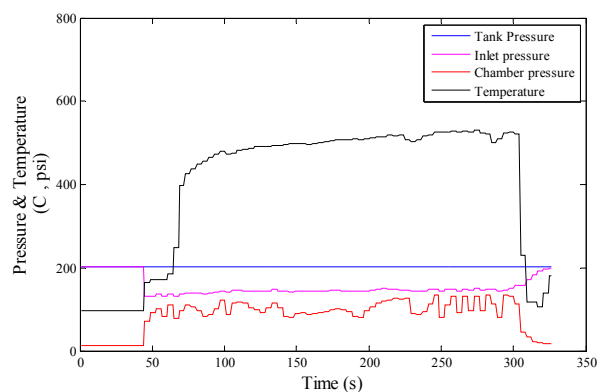

(a)

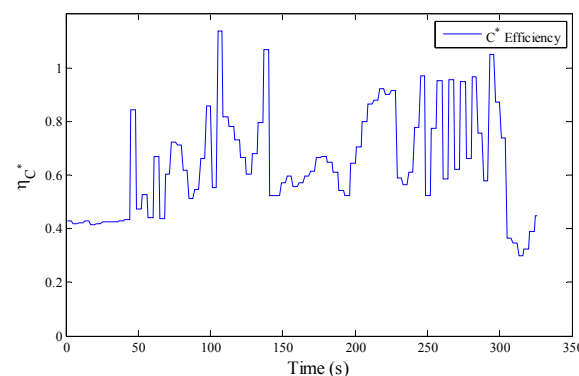

(b)

Fig. 8 Catalyst bed performance for an inappropriate catalyst bed (a) pressures and temperature profiles, (b) efficiency of characteristic exhaust velocity



Fig. 9 Sintering of composite catalyst bed after test

B. Test Case 2

After revising parameters of catalyst bed, the catalyst bed has been modified and tested over 4,000 s using 90% H₂O₂ propellant. Fig. 10 demonstrates one of tests of this catalyst bed which has been tested over 3,427 s. The test scenario includes 10 pulses and 1 continuous firing - each pulse is set as 100 ms ON and 3000 ms OFF to preheat the catalyst bed, and the continuous firing is performed until propellant running out, which is about 638 s in this figure.

During the pulse mode operations shown in Fig. 10 (a), the chamber pressure cannot be built up before the first 5 pulses, but the chamber temperature is increased along with the increase of pulse numbers. When the temperature is raised to 150°C, which provide enough energy to ignite the instantaneous decomposition processes in catalyst bed, the pressure is built up to peak within 100ms after solenoid valve is opened. Then the rest pulses have the same performance as the 5th pulse.

At the beginning of the continuous operation presented in Fig. 10 (b), the chamber pressure is increased momentarily to the design value but accompanying with slight fluctuation within ± 5 psi which is not obviously showed in previous tests. This unstable phenomenon also is shown in the chamber temperature profile. As the temperature reached 620°C, this fluctuation disappears and the chamber pressure is outstanding stable (within ± 1 psi) as well as the temperature. According to this result, the effect of temperature could contribute to the stability of the thruster performance. The chamber pressure fluctuation might be induced by the instantaneous decomposition of liquid H₂O₂ at catalyst bed downstream, which is caused by catalyst decay. The incomplete decomposition of H₂O₂ propellant could be improved by higher temperature that will lead to the two-phase reaction section moves back to the catalyst bed. Therefore, the chamber pressure becomes stable when the temperature reached specific value.

The flow rate, thrust force, C* efficiency, and Isp during operation are shown in Figs. 10 (c) and (d). These values could demonstrate the unstable effect of P_c obviously. In the beginning of the test, the thruster force has great oscillation, which is because the unstable phenomenon of P_c coupling with two-phase flow passing the catalyst bed and nozzle. When the two-phase flow across the nozzle throat, the available throat area decreases which blocks the reaction products from leaving the chamber and raises P_c momentarily. This spontaneous P_c build-up induces unstable propellant supply, which shows in the measurement of mass flow rate. The unstable flow supply also amplifies the P_c and thrust force oscillation, and causes greatly unstable phenomenon in the beginning of the test. Nevertheless, corresponds to the P_c, the force oscillation disappears when T_c raise to specific value. This also supports the speculation mentioned previously that the unstable phenomenon comes from the two-phase section of incompletely decomposed H₂O₂ propellant at downstream of catalyst bed.

When the timescale excess 150 s, the oscillation of thrust force becomes slight fluctuation. That is because the T_c is high enough to gasifying the two-phase section to whole gas-phase,

but not to decomposed H₂O₂ gases yet. This H₂O₂ gases still induce spontaneous decomposition processes at downstream of catalyst bed and cause these fluctuation. Once the T_c raise to specific value, these phenomena turn into smooth reaction and responds good performance.

In brief, the pressure fluctuation is ± 5 psi ($\pm 3\%$ in operation pressure) in the beginning of test and ± 1 psi ($\pm 0.6\%$ in operation pressure) at smooth period. The thrust force oscillation in the beginning of test and smooth period are ± 0.49 N ($\pm 57\%$ in design thrust) and ± 0.05 N ($\pm 6\%$ in design thrust), respectively. The C* efficiency is about 90% in the beginning of the test and approaches to 100% after 350 s hot-firing. The measured thrust force and I_{sp} are 0.7N and 102 s, respectively, which are lower than the ideal values. Several assumptions are listed in the following; (1) the thruster test platform is not integrity for such thrust-level measurement; (2) the contour of the nozzle throat is not perfect; (3) the surface roughness at the nozzle divergent section is not smooth. Because the throat diameter has significant impact to thruster performance, it is important to investigate whether it has been changed due to high temperature or potential corrosion. In Fig. 11 (a), we found the throat diameter is changed by catalyst bed deposition after cooling; however, it can be removed by gas purging and hand-drilling. The deposition layer should be blown away during hot-firing test. This situation will be discussed in the future.

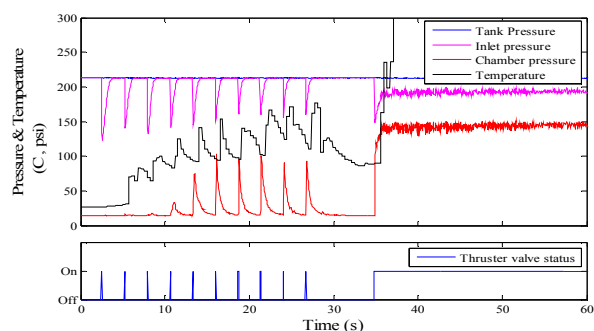

(a)

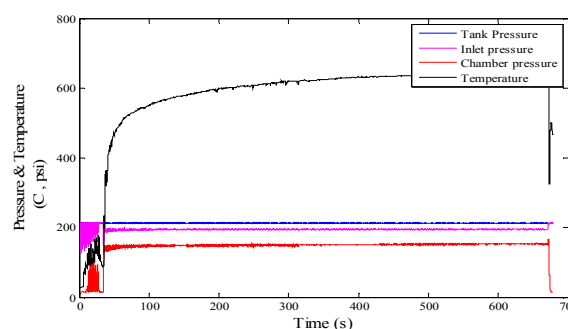

(b)

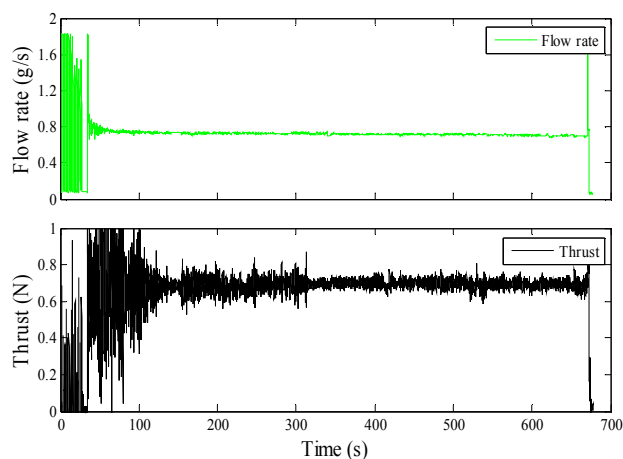

(c)

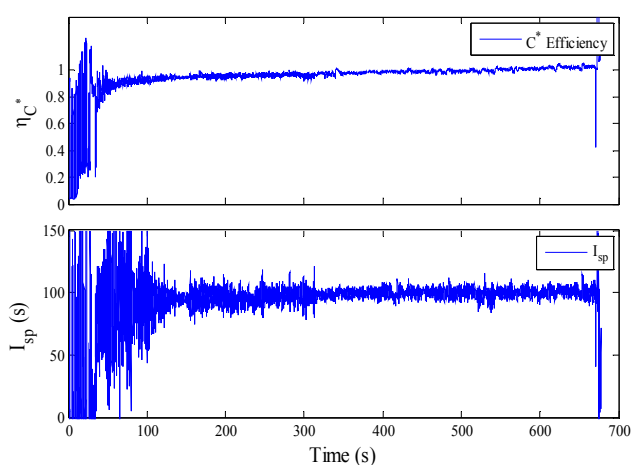

(d)

Fig. 10 Thruster performance for an appropriate catalyst bed (a) pressures and temperature profiles of pulse-mode operation; (b) pressures and temperature profiles of long-term operation; (c) mass flow rate and thrusting force; (d) efficiency of characteristic exhaust velocity and specific impulse



(a)

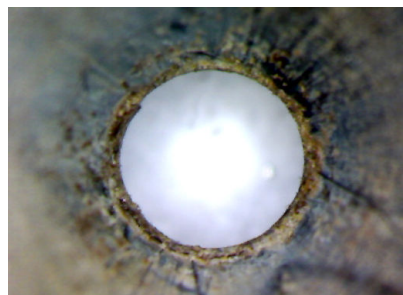

(b)

Fig. 11 The nozzle throat of the H_2O_2 thruster (a) after hot-firing test; (b) after mechanical rework

V. CONCLUSIONS

A 1N thruster prototype using combination of silver and ceramic material as catalyst bed for the hydrogen peroxide monopropellant has been tested by self-development thrust measurement system. Results show the stability is good by monitoring the chamber pressure and temperature. The thrust level is 0.7N in ambient and the specific impulse is about 102 seconds. Repeatability, blow-down test and environmental test are scheduled to perform in September 2013.

ACKNOWLEDGMENT

Authors would like to thank professor Chao and his research group at the National Cheng Kung University for their technical support and valuable discussions.

REFERENCES

- [1] W. J. Larson and J. R. Wertz, *Space Mission Analysis and Design*, Second Edition, Microcosm, Inc., 1992.
- [2] G. P. Sutton, *Rocket Propulsion Elements*, John Wiley & Sons, Inc., 1992.
- [3] R. W. Humble, G. N. Henry, and W. J. Larson, *Space Propulsion Analysis and Design*, The McGraw-Hill Companies, Inc., Primis Custom Publishing, 1995.
- [4] M. Tajmar, *Advanced Space Propulsion Systems*, Springer, 2003.
- [5] W. C. Schumb, C. N. Satterfield, and R. L. Wentworth, *Hydrogen Peroxide*, Reinhold Publishing Company, New York, 1955.
- [6] D. Andrews, "The Industrial History of the Ansty Rocket Department, 1946 to 1971," July 26, 1998
- [7] L. E. James and W. H. Stillwell, "The Hydrogen-Peroxide Rocket Reaction-Control System for the X-1B Research Airplane," NASA Technical Note TN D-158, Flight Research Center, Edwards, CA, Dec. 1959.
- [8] J. F. Runckel, C. M. Willis, L. B. Salters Jr., "Investigation of Catalyst Beds for 98-Percent-Concentration Hydrogen Peroxide," NASA TN D-1808, Langley Research Center, Hampton, Virginia, 1963.
- [9] W. E. Armstrong, C. Z. Morgan, L. B. Ryland, and H. H. Voge, "Development of Catalysts for Monopropellant Hydrazine Decomposition," Shell Development Company Report No. S-13947, Contract NAS 7-97, 1964.
- [10] J. Clark, *Ignition - An Informal History of Liquid Rocket Propellants*, Rutgers University Press, New Brunswick, 1972.
- [11] E. Wernimont and P. Mullens, "Recent Developments in Hydrogen Peroxide Monopropellant Devices," AIAA-99-2741, General Kinetics, LLC, Aliso Viejo, CA
- [12] D. L. Hitt, C. M. Zakrzewski, and M. A. Thomas, "MEMS-based satellite micropropulsion via catalyzed hydrogen peroxide decomposition, *Smart Mater. Struct.*, vol. 10, pp. 1163-1175, 2001.
- [13] J. Ponzio, "Small Envelope, High Flux 90% Hydrogen Peroxide Catalyst Bed," 39th AIAA/ASME/SAE/ASE Joint Propulsion Conference and

- Exhibit, Huntsville, Alabama, 20-23 July 2003,
- [14] C. Scharlemann, M. Schiebl, R. Amsüss, and M. Tajmar, "Development of Miniaturized Green Propellant Based Mono- and Bipropellant Thrusters," 43rd AIAA/ASME/SAE/ASEE Joint Propulsion Conference & Exhibit, AIAA 2007-5580, Cincinnati, OH, 8 - 11 July 2007.
 - [15] A. Pasini, L. Torre, L. Romeo, A. Cervone, L. d'Agostino, A. J. Musker, and G. Saccoccia, "Experimental Characterization of a 5 N Hydrogen Peroxide Monopropellant Thruster Prototype," 43rd AIAA/ASME/SAE/ASEE Joint Propulsion Conference & Exhibit, AIAA-2007-5465, Cincinnati, OH, 8 - 11 July 2007
 - [16] S. L. Lee and C. W. Lee, "Performance characteristics of silver catalyst bed for hydrogen peroxide," *Aerospace Science and Technology*, vol. 13, no. 1, pp. 12-17, 2009.
 - [17] L. Pirault-Roy, C. Kappenstein, M. Guèrin, R. Eloirdi, and N. Pillet, "Hydrogen Peroxide Decomposition on Various Supported Catalysts Effect of Stabilizers," *Journal of Propulsion and Power*, vol. 18, no. 6, 2002, pp. 1235-1241.
 - [18] Y. A. Chan, H. W. Hsu, and Y. C. Chao, "Development of a HTP Mono-propellant Thruster by Using Composite Silver Catalyst," *44th AIAA/ASME/SAE/ASEE Joint Propulsion Conference and Exhibit*, San Deigo, CA, 31 July - 3 August, 2011.