

# Eco-Roof Systems in Subtropical Climates for Sustainable Development and Mitigation of Climate Change

M. O'Driscoll, M. Anwar, and M. G. Rasul

**Abstract**—The benefits of eco-roofs is quite well known, however there remains very little research conducted for the implementation of eco-roofs in subtropical climates such as Australia. There are many challenges facing Australia as it moves into the future, climate change is proving to be one of the leading challenges. In order to move forward with the mitigation of climate change, the impacts of rapid urbanization need to be offset. Eco-roofs are one way to achieve this; this study presents the energy savings and environmental benefits of the implementation of eco-roofs in subtropical climates. An experimental set-up was installed at Rockhampton campus of Central Queensland University, where two shipping containers were converted into small offices, one with an eco-roof and one without. These were used for temperature, humidity and energy consumption data collection. In addition, a computational model was developed using Design Builder software (state-of-the-art building energy simulation software) for simulating energy consumption of shipping containers and environmental parameters, this was done to allow comparison between simulated and real world data. This study found that eco-roofs are very effective in subtropical climates and provide energy saving of about 13% which agrees well with simulated results.

**Keywords**—Climate Change, Eco/Green roof, Energy savings, Subtropical climate.

## I. INTRODUCTION

CLIMATE change is one of the biggest issues facing Australia and the international community. The consumption of energy in the building sector contributes substantially to Australia's greenhouse gas emissions. Chowdhury [1] states that in a subtropical climate, year round cooling is required in buildings to maintain a comfortable indoor environment. Energy use is a well-known component in the production of greenhouse gases. The reduction of energy consumption, in turn, reducing the production of greenhouse gases can be achieved through effective operation of the built environment.

With the large growth in population in recent decades, rapid urbanization has occurred. This has required city buildings to be highly concentrated. A high concentration of buildings triggers environmental issues, in particular; the urban heat

island (UHI) effect. "The term "heat island" describes built up areas that are hotter than nearby rural areas. The annual mean air temperature of a city with 1 million people or more can be 1.8–5.4°F (1–3°C) warmer than its surroundings. In the evening, the difference can be as high as 22°F (12°C). Heat islands can affect communities by increasing summertime peak energy demand, air conditioning costs, air pollution and greenhouse gas emissions, heat-related illness and mortality, and water quality" [2].

Placing vegetation on buildings reduces the surface temperature, reduces ambient temperature through the consumption of solar heat for transpiration and photosynthesis. Wong [3] states that vegetation placed on buildings provides visual enhancement, air and noise control and contributes thermal benefits to the building and surrounding area. The shaded surface emits less long wave radiation due to the lower surface temperature. All of the above contribute significantly to a reduction in energy consumption for cooling and also assists in the mitigation of the UHI effect. In order to mitigate the building sector's negative impact on the environment, harmony needs to be reached between the built and natural environments. This can be assisted by the addition of rooftop greenery systems.

This study examines the benefits and impact of rooftop greenery system on energy consumption in subtropical climate in Australia. The main benefits of undertaking this study is a benefit to the community in terms of energy saving, improved air quality and reduction of greenhouse gas emissions. It will also provide a simple and effective way to assist in the mitigation of climate change.

## II. GREEN ROOF TECHNOLOGY

Green roofs come under many different names, some of which are; eco-roofs, living roofs, planted roofs and vegetated roofs. They use plants to improve roofs performance, appearance or both. They fall into two main categories, which are; intensive and extensive [4]. While these different categories don't have a technical definition, intensive green roofs is much like standard roof top gardens. They allow the growth of many different plants, are readily accessible and are used as amenities for people in the building. Extensive green roofs however, are simpler, lighter and are generally planted with drought resistant, low growing plants [4]. Fig. 1 shows both intensive and extensive green roofs.

M. Driscoll is with the Central Queensland University, Rockhampton, Queensland 4702, Australia (e-mail: martinodriscoll@cqmail.com).

M. Anwar is with the Central Queensland University, Rockhampton, Queensland 4702, Australia (corresponding author, e-mail: m.anwar@cqu.edu.au).

M.G. Rasul is with the Central Queensland University, Rockhampton, Queensland 4702, Australia (e-mail: m.rasul@cqu.edu.au).

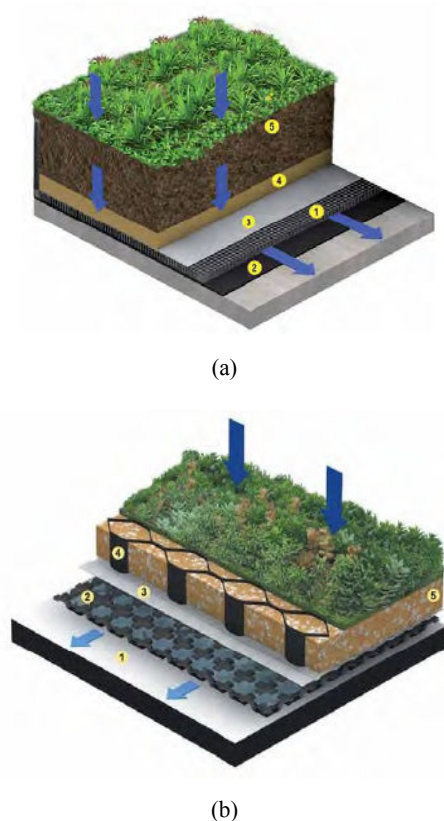

Fig. 1 Types of Green Roof system in a) Intensive Green Roof System includes (1) The drainage system (2) Water proofing membrane (3) Filter fabric (4) Sand and (5) Lightweight Growing medium and b) Extensive Green Roof System includes (1) Waterproofing membrane (2) Drainage System (3) Filter fabric (4) Cellular Confinement Cells (5) Lightweight Growing medium [5]

Living in a tropical climate means that a building will require cooling for the majority of the year to ensure a comfortable living environment. This constant cooling requires a large amount of energy, energy use and production has been accepted as being a large contributor to worldwide greenhouse emissions. Australia's electrical energy consumption has been rising for the past decade and is expected to continue to rise in the near future, in the year 2000, Australia consumed 173.34 billion kilowatt hours (bkWh) and in 2010 the consumption had risen to 220bkWh (The Energy Supply Association of Australia (ESAA)). From a report produced by the Built Environment Research Unit in Queensland in 2000, it can be seen that the cooling of buildings, both commercial and residential accounted for 32% of Queensland's annual electricity consumption. Greenhouse gases are harmful to the environment and are one of the major contributors to global warming. Effectively balancing the development of land and environmental impact is important in the current environmental climate. The use of green roofs is beginning to be seen as an effective means to create harmony between buildings and the surrounding environment and mitigating the negative effect on climate change that development can bring.

Rooftop greenery systems have a positive effect on building aesthetics and the thermal efficiency of the roof. A field study was conducted by Wong [3]. This study measured the impact of intensive green roofs on the surface temperature of the roof surface. It was found that, as expected, the temperature due to the shade created was lower than the bare roof. Rooftop greenery systems can also assist in an extension of the roofing membrane; this is due to the filtering of UV light and also the damping of hail during storms. The filtering of the UV light and shading of the roof lowers the surface temperature. This reduction in surface temperature can reduce the energy required for cooling, which in turn, leads to a reduction in greenhouse gas emissions. Green roofs also delay runoff into the sewage system; this has been reported by Eumorfopoulou and Aravantinos [6]. This delay in runoff can help reduce the amount and frequency of combined sewage overflow (CSO), CSOs are a significant environmental issue for large cities [7]. Lui and Baskaran [7] also state that the rooftop greenery kept the roof membrane cooler and thus helping the building cool, by direct shading, evaporative cooling from the plants, the medium in which they are growing, the added thermal insulation from the growing medium and plants and the thermal mass effects due to the growing medium.

The plants used in rooftop greenery systems can absorb large amounts of solar energy through their biological functions. This leads to a reduction in solar energy that causes temperature change in the roof membrane when compared to a bare roof. On top of the large amount of shelter the plants can provide, the growing medium provides added protection from solar radiation. This causes a significant difference when compared to a bare roof that receives 100% of the solar radiation. The strategic placement of plants on the buildings surface can significantly reduce the surface temperature, which in turn, will reduce energy requirements for air-conditioning [8]. The heat transfer rate of a rooftop greenery system is different to that of a bare roof. This is because the external climatic factors such as; temperature, relative humidity, solar radiation and winds are reduced as they pass through the plants and growing membrane on the roof. The internal climate of the building is affected by the remaining solar energy that passes through the rooftop greenery and is not used by the plants for their biological functions such as; photosynthesis, respiration, evaporation and transpiration.

European countries like Germany, Switzerland, Netherlands, Italy, Austria, Norway, Sweden, Hungary, Greece and UK have very strong association for promoting green roofs. The City of Linz in Austria has been paying developers to install green roofs since 1983 and in Switzerland it has been a federal law to install green roofs since the late 1990s. Germany is the pioneer in modern green roof and they nurtured the technology since 1960s. Nowadays more than 10% of all German roofs have been greened [9]. Green roofs in United States are also getting more popular. Pictures of green roof from Germany and USA are shown in Figs. 2 and 3. Singapore also has taken initiative for implementing green roofs (Fig. 4).



Fig. 2 Green roof at office/ school complex in Germany [10]



Fig. 3 Green roof on California Academy of Sciences [11]



Fig. 4 Green roof on school of Art, Design and Media at Nanyang Technological University in Singapore

Green roofs can be recognized as being one of the more quickly developing fields in the built environment to reduce the negative effects of climate change. Research and further study into rooftop greenery systems and their design & implementation on both new developments and retrofits is required.

The use of rooftop greenery systems can assist in addressing the challenges presented by climate change. The plants and other greenery are the key to the benefits provided by the rooftop greenery systems. The use of native plants flowering plants is important because they can withstand the Australian climate while also providing big payoffs in the reduction of fossil fuel created energy use. As rooftop greenery systems are a natural means of providing cooling based on evaporative and radiative principles, they need to be analysed further for their use in subtropical climates. Rooftop greenery technologies have not been widely recognized or understood in Australia yet. While there is a lot of potential in green roof technology, they have not been fully evaluated for use in the Australian climate. This study would allow for a

greater understanding of rooftop greenery systems and thus help facilitate their wider acceptance for use in Australia. This study investigates the potential of the green roofs as a natural means of providing cooling in a subtropical climate. While also undertaking mathematical and software modelling to display the thermal behaviour of a green roof.

### III. METHODOLOGY

#### A. Experimental Measurement

In order to provide the best analysis possible, areal rooftop greenery system was used for data collection and comparison. Two shipping containers have been modified to resemble small office areas. Each has a 900mm x 900mm glass sliding window, a 1700mm x 1950mm glass sliding door, a packaged air conditioning unit with data logger connected for recording energy consumption, temperature and humidity sensors. One of the shipping containers was also fitted with a rooftop greenery system, which consists of the following; corrugated steel sheet metal has been fixed to the top of the container at 3° to ensure water runoff. A 230mm galvanized aluminum skirting was used to contain the green roof materials. Fig. 5 shows a photograph and schematic diagram [12] of the experimental green roof setup.



(a)

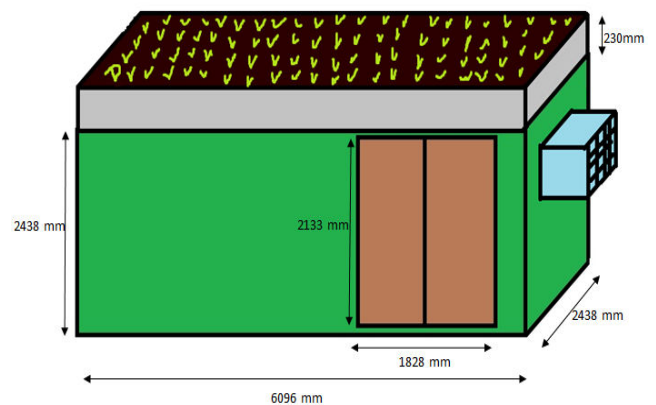

(b)

Fig. 5 (a) photograph and (b) schematic diagram of experimental green roof [12]

Both containers are set in an open and flat ground which has minimum shading effect. The site of the facility is an open and flat ground, therefore has minimal shading effect. Water, electricity and internet supplies are available in this location.



Nearest bureau of meteorology (BOM) is about 13km away from this sustainable precinct.

The waterproofing membrane used was GRT HP 700. GRT HP 700 is UV stable, polyurethane waterproofing membrane system. To ensure efficient drainage, ElmichVersicell® lightweight drainage modules were used. This high strength, interlocking modules capture high amounts of water and also protects the waterproofing membrane.

ElmichVersidrain® 25P was also used; this drainage sheet is used due to its cost effectiveness for water management. It also has the ability to store large amounts of water and discharge this water via a capillary action. In order to keep the growing media out of the drainage layer, a needle punched geotextile fabric has been used.

The growing media used was; Enviroganics® Bioganic Earth substrate, it is a lightweight and organic based product. It is a mix of different long lasting material that doesn't slump and will remain effective for two years. It contains materials such as; composted saw dust, peat moss, washed sand, coco peat, fertilizer and water retaining crystals. Each of these has the ability to store large amounts of water. The dry weight of the substrate is 300kg/m<sup>3</sup> and the wet weight is 450kg/m<sup>3</sup>.

Due to the particular nature of a subtropical climate, the plants selected needed to be able to tolerate the harsh sun, high temperature, dryness and humidity. As there is limited research available on rooftop greenery systems in subtropical climates, a variety of native and hardy plants were selected. These are; *Helichrysum italicum*, Rhoec, Callistemon Captain Cook, Scaevola, *Eremophila maculata* and Dianella little jess. A time controlled watering system was also installed to ensure the plants are watered daily.

The data was collected using data loggers and compared using Microsoft Excel, this enabled an effective comparison to be made between the energy required for cooling, the temperatures within the containers when the air conditioning is not running and the humidity. The ability to compare the temperature when not cooling will provided very clear evidence of the effect of a rooftop greenery system on the internal temperature of a building.

### B. Computer Simulation

Software modelling has become an important phase of any design project as it allows the designer to view the effects of certain aspects and changes to the system without any of the risks associated with real world modelling. Software modelling also enabled the quick alleviation of any errors present because testing could be done almost instantly. The software modelling was undertaken alongside the real world experimental measurement. The results are compared and used for verification. The software used is called; 'Design Builder' it "is a state-of-the-art software tool for checking building energy, carbon, lighting and comfort performance. The basic steps that were used to create the model are outlined below;

1. Begin by running software and setting location
2. Select new building
3. Draw required outline of building
4. Set building/ construction materials

5. Set required rooftop greenery for outer layer
6. Set heating/ cooling design data
7. Run simulation
8. Verify results
9. Make any required modifications and repeat

### 1. Assumptions & Approaches Used

#### Shipping Containers

In order to model the shipping container in DesignBuilder, some assumptions needed to be made, these were;

- DesignBuilder has many inbuilt building materials and data, some of these were not exact matches to what was used for construction of the shipping container offices, but it was assumed their properties were close enough to be suitable for the simulation.
- DesignBuilder has inbuilt weather data for different areas around the world, it was assumed that the data for Rockhampton valid at the time of simulation.
- All dimensions for the shipping container offices were site measured.

### 2. Input Data

#### Green Roof Shipping Container:

- Roof  
The roof consisted of 200mm of eco roof material, followed by the tin sheeting, sealant, 2mm steel shipping container roof, 15mm air gap and the 1.6mm inner steel layer.
- Walls  
The walls consist of 6 layers; the outermost layer is 2mm thick steel, followed by a 50mm air gap, 1.6mm thick steel, 5mm air gap, 6mm MW glass wool and 13mm thick lightweight plywood.
- Openings  
1700x1950mm glass sliding door  
900x900 glass window
- Lighting  
One suspended fluorescent light.
- HVAC  
Packaged direct expansion and cooling only

#### Non-Green Roof Shipping Container:

All input data same as 'green roof shipping container' except for the roof, which is as follows;

- 2mm steel shipping container roof, 15mm air gap and the 1.6mm inner steel layer.

A model of the shipping containers were produced, one with the eco roof and one without. The simulation was run over a year long period to allow a good spread of data. Fig. 6 shows the DesignBuilder model of shipping container.

### C. Energy Balance

The calculation of thermal behaviour for rooftop greenery is quite limited [13]. For the radiative exchange within the plant canopy, there is a model of the heat transfer processes. The plant canopy affects the convective heat transfer, evapotranspiration from the soil and plants, as well as the heat of conduction and storage in the soil layer. The rooftop

greenery system energy balance is predominately affected by the radiative force from the sun. The energy balance is caused by the combined effect of the convective and evaporative heat flux from the soil and plants with the conduction of heat energy into the soil. The model included the following;

- Moisture balance which is simplified to allow for precipitation, irrigation and moisture transfer between the different soil layers (surface layer and root zone).
- Plant canopy and soil energy balance.
- The temperature of the surface of the soil and the foliage to enable the extraction of the heat flux information for the energy balance.

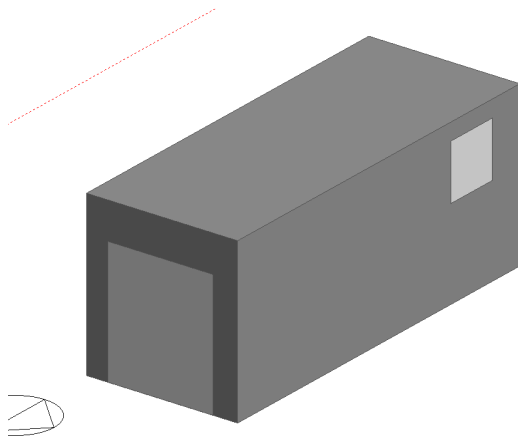

Fig. 6 Shipping container model created in DesignBuilder

The different parameters for the evaporative and convective heat flux are detailed in the analysis of the energy balance. The final result is a set of simultaneous equations for soil surface and foliage temperature. Frankenstein and Koenig [14] give the energy equation as follows;

$$F_f = \sigma_f [I_s^\downarrow (1 - \alpha_f) + \epsilon_f I_{\nu}^\downarrow - \epsilon_f \sigma T_f^4] + \frac{\sigma_f \epsilon_g \epsilon_f \sigma}{\epsilon_f} (T_g^4 - T_f^4) + H_f + L_f$$

The overall energy balance at the soil surface is given by Frankenstein and Koenig [14].

$$F_g = (1 - \sigma_f) [I_s^\downarrow (1 - \alpha_g) + \epsilon_g I_{\nu}^\downarrow - \epsilon_g T_g^4] - \frac{\sigma_f \epsilon_g \epsilon_f \sigma}{\epsilon_f} (T_g^4 - T_f^4) + H_g + L_g + K \times \frac{\partial T_g}{\partial z}$$

where;  $F_f$  is net heat flux to foliage layer ( $W/m^2$ ),  $F_g$  is net heat flux to ground surface ( $W/m^2$ ),  $I_s^\downarrow$  is total incoming short wave radiation ( $W/m^2$ ),  $I_{\nu}^\downarrow$  is total incoming long wave radiation ( $W/m^2$ ),  $L_f$  is foliage latent heat flux ( $W/m^2$ ),  $L_g$  is ground latent heat flux ( $W/m^2$ ),  $T_f$  is leaf temperature (K),  $T_g$  is ground surface temperature (K),  $\alpha_f$  is short wave reflectivity of the canopy,  $\alpha_g$  is short wave reflectivity of ground surface,  $\epsilon_f$  is emissivity of canopy,  $\epsilon_g$  is emissivity of the ground surface,  $\epsilon_l$  is the sum of  $\epsilon_g + \epsilon_f \epsilon_g$ ,  $\sigma$  is the Stefan-Boltzmann constant ( $5.679 \times 10^{-8} W/m^2 K^4$ ),  $\sigma_f$  is the fractional vegetation coverage,  $f$  is foliage surface,  $g$  is ground surface and  $S$  is short wave.

The controlled variables were air temperature, solar radiation, relative humidity of the air, cooling capacity and the water content of the soil. The technique outlined above was used to determine the savings in energy consumption and required cooling with roof types.

#### IV. RESULTS AND DISCUSSION

##### A. Real World Experimental Measurement

The energy used by the air conditioner units in the shipping containers between the 26<sup>th</sup> March and 1<sup>st</sup> April is displayed in Fig. 7. It is clear from Fig. 7 that, during the hottest part of the day, when the energy used for cooling is at its maximum, the energy required for the shipping container with the green roof is lower.

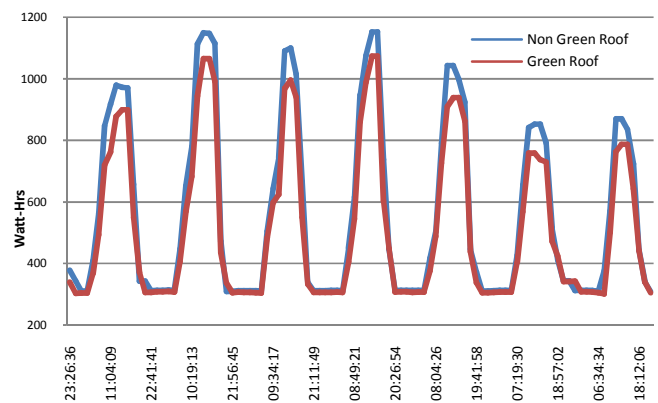

Fig. 7 Shipping container energy consumption

Fig. 8 displays the energy used by the air conditioning units in the shipping containers for a 24hours period on 4<sup>th</sup> March 2013. Depending on the outdoor air temperature, the air conditioning energy consumption varies. During the night and early morning, the non-green roof internal temperature is lower than that of green roof due to high thermal conductivity nature of metal structure; however, during day time the energy consumption with green roof is consistently lower than without green roof. Both air conditions are set at 24°C.

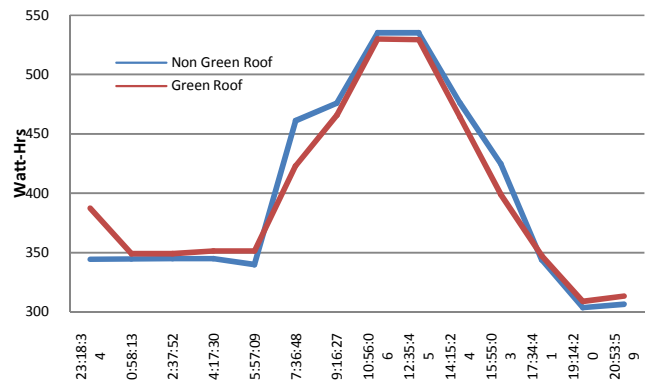

Fig. 8 Air conditioning energy consumption profile for 4th March 2013

Fig. 9 displays the temperature for both shipping containers without air conditioning for 24 hours period on February 10<sup>th</sup> 2013. From the figure, it can be seen that during the day time the shipping container with the green roof maintains lower temperature than the shipping container without the green roof. At 1620, the temperature difference between two containers is about 4.5°C.

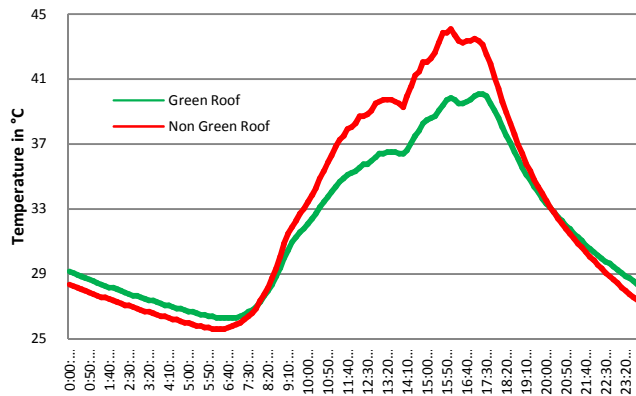

Fig. 9 Temperature profile of green roof and non-green roof without air condition in a typical summer day

Fig. 10 compares the humidity within the shipping containers at maximum daily temperatures from 1st December 2012 to 7th February 2013. The average maximum humidity taken from the Australian Bureau of Meteorology for the dates covered is found to be 70%. Apart from two spikes in the data, the humidity inside the shipping containers remains consistently below the 70% daily maximum average.

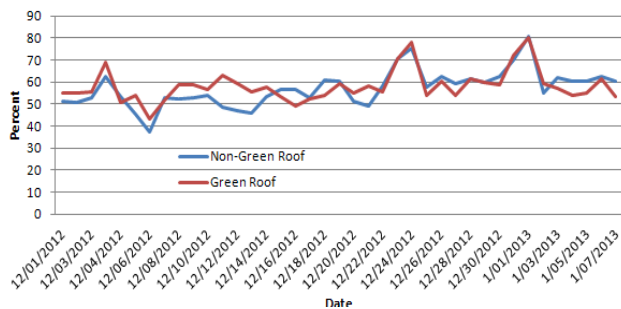

Fig. 10 Comparison of shipping containers humidity at maximum daily temperature

Tables I and II show the percentage difference between energy required for the non-green roof and green roof shipping containers (in Watt Hours). As can be seen in the tables, in every instance, the green roof shipping container required less energy to maintain a comfortable working environment. Over the two tables, there is an average of 12.4% reduction in energy consumption by adding the rooftop greenery system.

### B. Computer Simulation

Fig. 11 was taken directly from DesignBuilder for the shipping container with the eco-roof for January 15th. The top

graph displays the temperature. As can be seen, the variations in air, radiant and operative temperatures are small, which results in a more comfortable working environment.

TABLE I  
 HIGH CONSUMPTION

| Date           | Time     | Non-Green Roof | Green Roof | Difference      |
|----------------|----------|----------------|------------|-----------------|
|                |          | (Watt-Hrs)     | (Watt-Hrs) | %               |
| 26/03/13       | 12:43:00 | 979.0662       | 878.3923   | 11.46115        |
| 27/03/13       | 13:38:00 | 1149.040       | 1065.582   | 7.832152        |
| 05/04/13       | 11:53:00 | 934.7448       | 806.0343   | 15.96837        |
| 09/04/13       | 12:12:00 | 652.1208       | 589.0379   | 10.70948        |
| <b>Average</b> |          |                |            | <b>11.49279</b> |

TABLE II  
 LOWER CONSUMPTION

| Date           | Time     | Non-Green Roof | Green Roof | Difference      |
|----------------|----------|----------------|------------|-----------------|
|                |          | (Watt-Hrs)     | (Watt-Hrs) | %               |
| 13/03/13       | 17:28:00 | 725.1985       | 629.2481   | 15.24842        |
| 14/03/13       | 10:05:00 | 735.26         | 648.1812   | 13.43433        |
| 26/03/13       | 01:06:00 | 343.5399       | 302.4306   | 13.59297        |
| 09/04/13       | 08:53:00 | 528.9119       | 475.4908   | 11.23494        |
| <b>Average</b> |          |                |            | <b>13.37766</b> |

As can be seen from the relative humidity graph, the relative humidity in the shipping container sits within the comfortable range set by the ASHRAE standard, except between 1am and 7am, where it is above 65%. Fig. 12 displays the trends for fuel, temperature, heat balance, system loads and total fresh air over a 365 day period for the shipping container with the eco-roof.

Fig. 13 displays the outputs for the simulation of the shipping container without the green roof. As can be seen in the temperature graph, the radiant temperature peaks much higher than it does in the shipping container with the green roof. The humidity in the non-green roof shipping container also raises 10-15% higher than that of the shipping container with the green roof.

Fig. 14 displays the trends for fuel, temperature, heat balance, system loads and total fresh air over a 365 day period for the shipping container without the eco-roof.

From the simulations the total energy required annually for cooling the containers was determined. The total energy required for the shipping container without the green roof was; 5285kWh, while the total energy required for the shipping container with the green roof was only 4477kWh which indicates 15% reduction in energy requirements with the additional insulation from the rooftop greenery system.

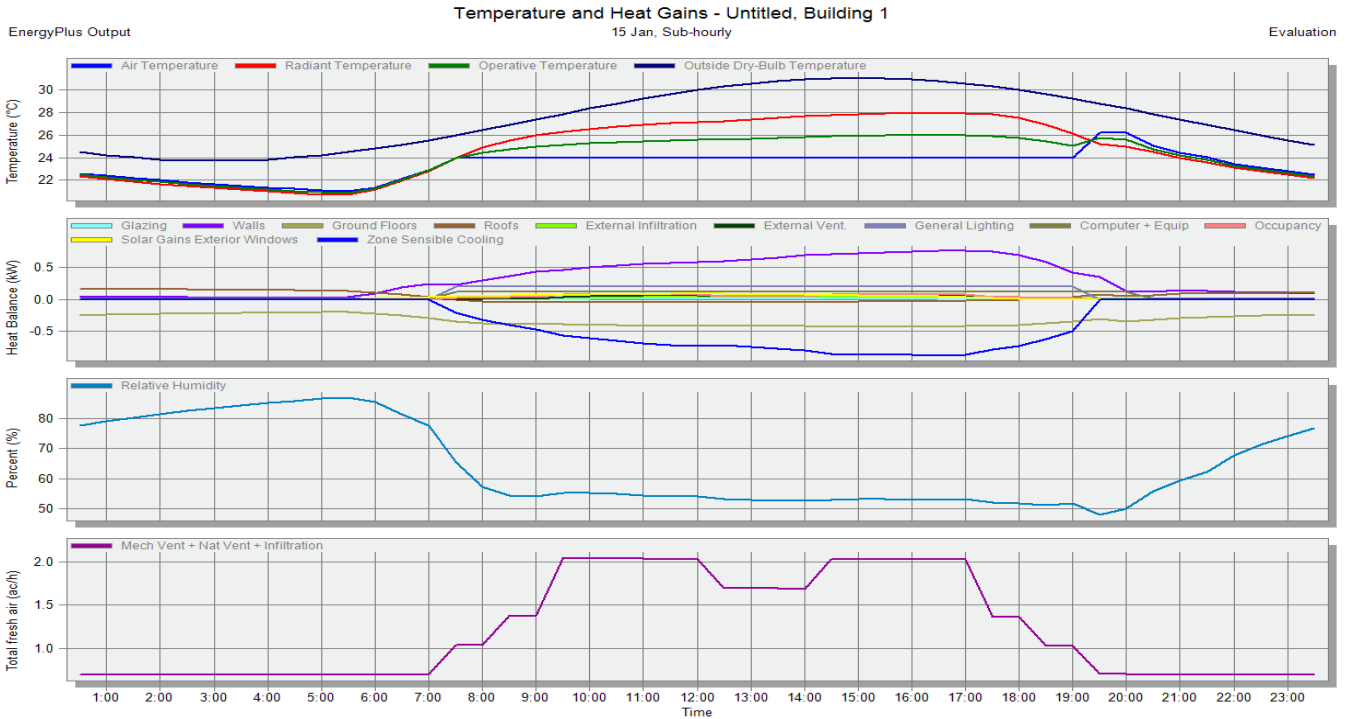

Fig. 11 GR Shipping Container Temperature & Heat Gains

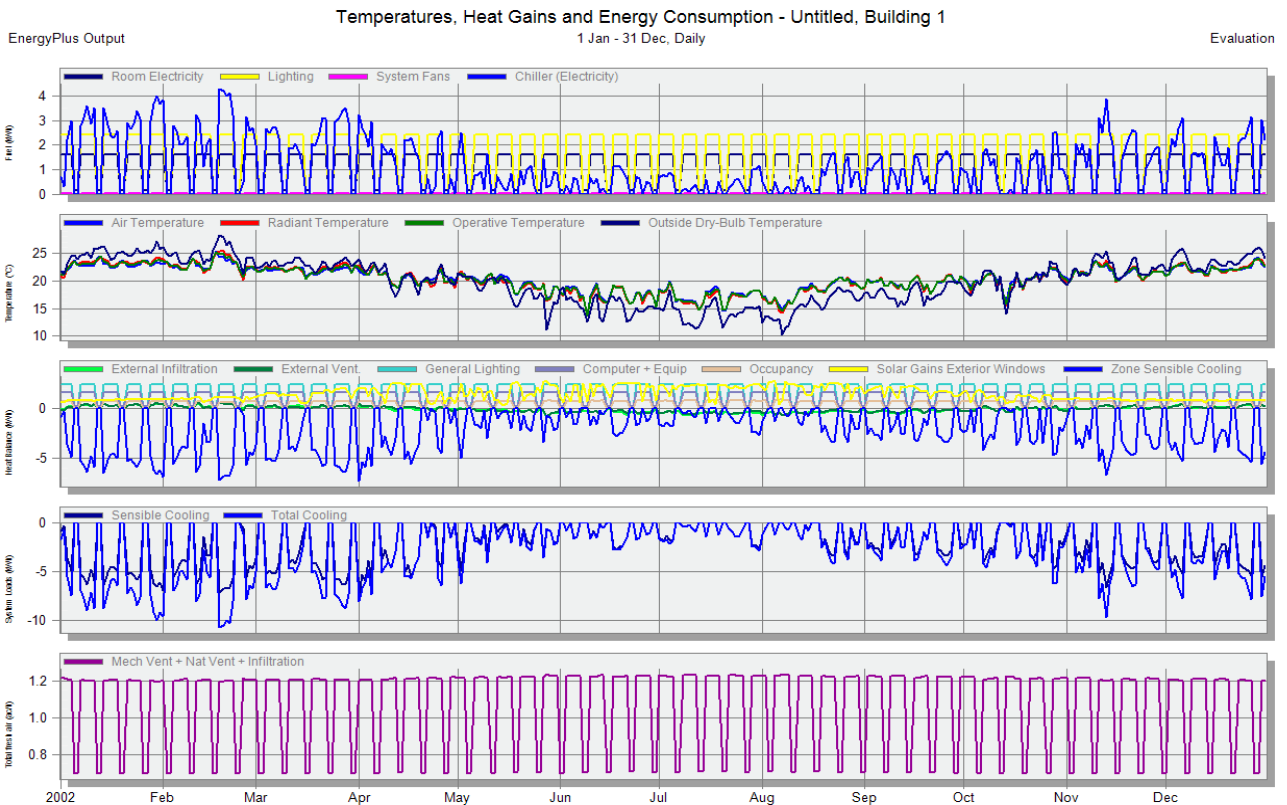

Fig. 12 GR shipping container trends

Temperature and Heat Gains - Untitled, Building 1

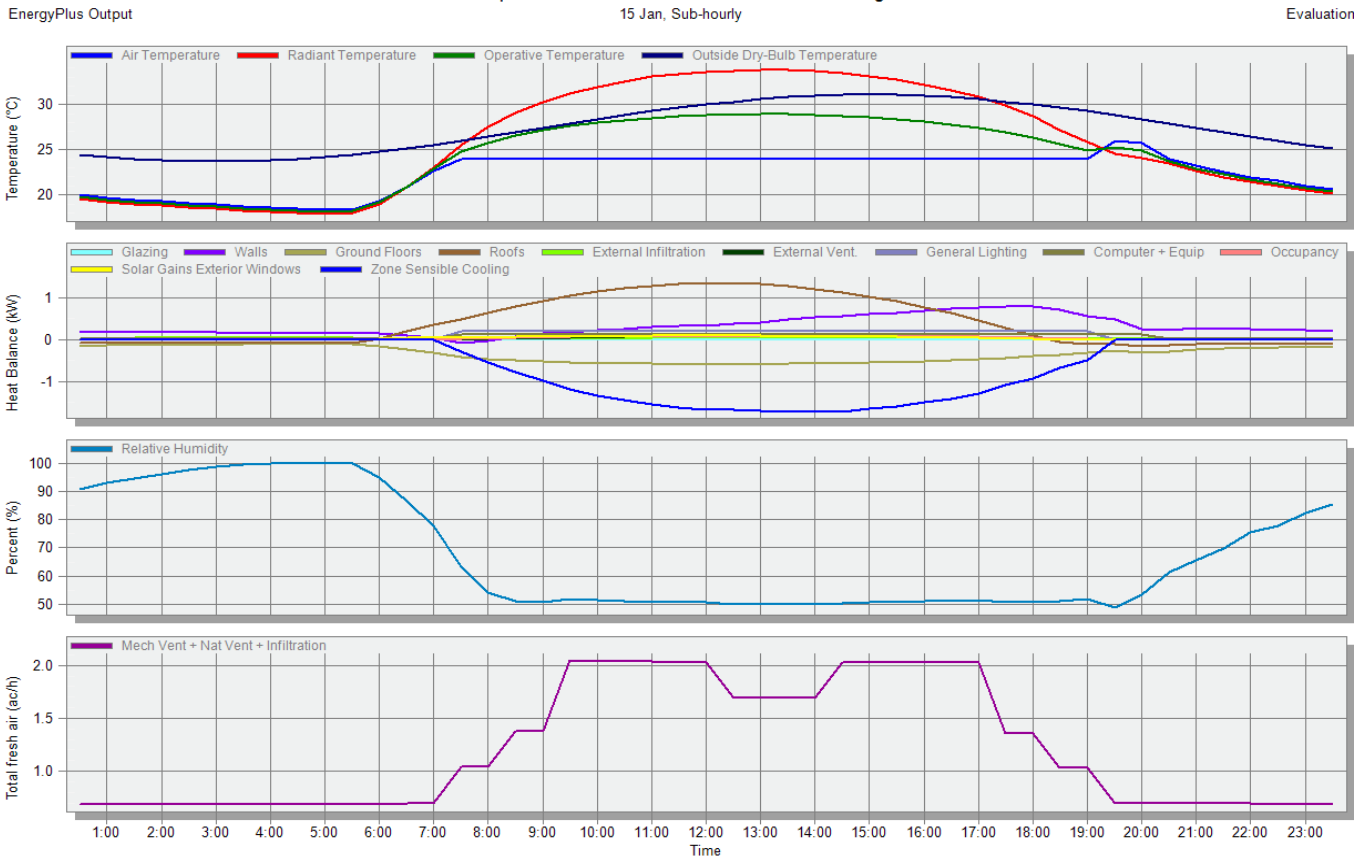

Fig. 13 NGR shipping container temperature and heat gains

Temperatures, Heat Gains and Energy Consumption - Untitled, Building 1

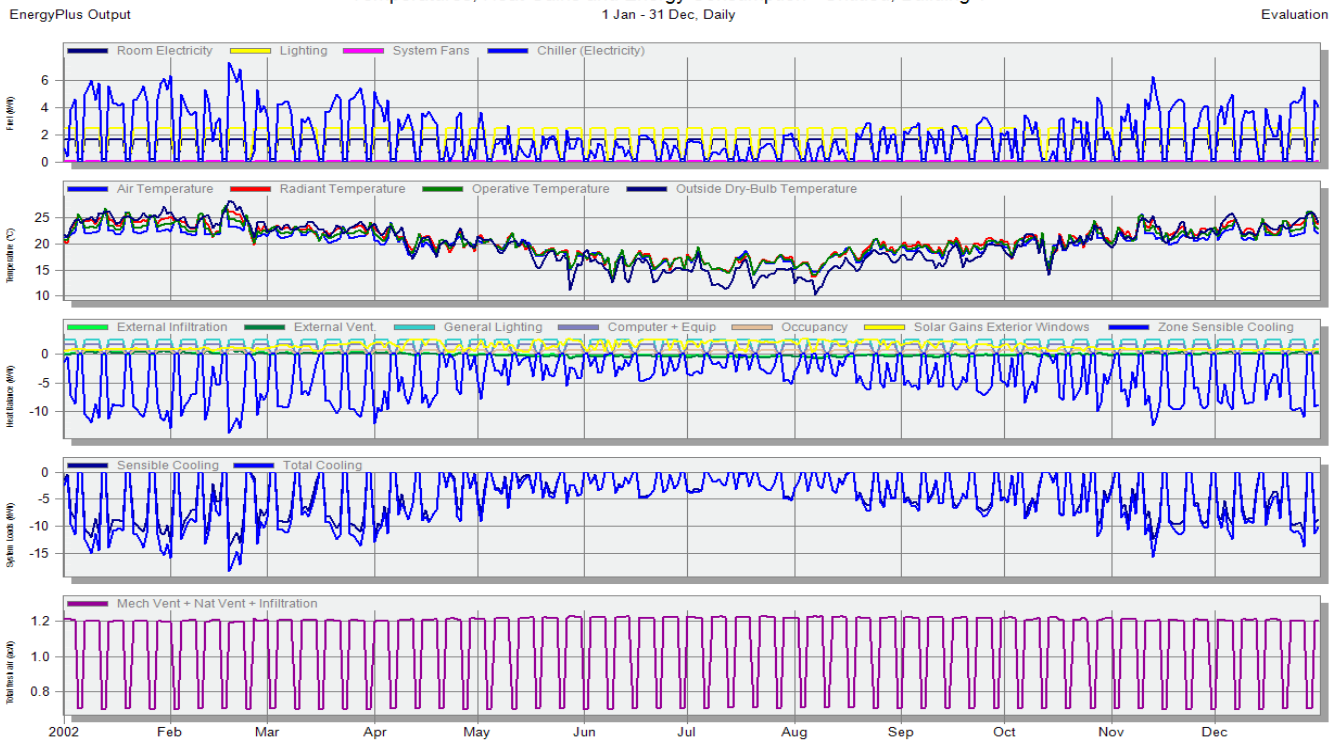

Fig. 14 NGR shipping container trends



Tables I and II display the real world energy saving data collected from the shipping containers. As can be seen from the high and low consumption data, there is an average cooling load reduction of 12.4%. This average of 12.4% is slightly less than the 15% found in the computer simulations. The 15% was obtained with the ideal conditions that a simulation can provide and the anomalies of real world data collection, such as unseasonal weather, are not taken into consideration. Over a long period of time, a 12% to 15% reduction in energy costs is significant. This lower energy consumption also lowers the carbon footprint of the building, which in turn, is one small step toward the mitigation of climate change.

There were some limitation to this study, firstly, the use of the shipping containers for the collection of data has been limited, ideally, it would be beneficial to observe the different data trends throughout the different seasons over the period of a year. Secondly, the weather data available in Design Bulider for the simulations in Rockhmapton was limited; however, the results obtained were in line with what was expected and in line with what was expected and obtained through real world data collection.

## V. CONCLUSIONS

It was found from this study that the eco-roofs reduce about 15% of the cooling load on a building by providing rooftop insulation. This reduced cooling load results in lower energy consumption and thus monetary savings. They also provide environmental benefits that assist in the mitigation of climate change by reducing a building's carbon footprint and converting carbon dioxide into oxygen. On top of this, the plants use the solar radiation for their biological processes, which assists in the mitigation of the urban heat island effect. It is recommended that further studies be conducted over longer periods of time that include real world testing and data collection. Doing so will allow the benefits to be seen throughout the four different seasons in a subtropical climate. Studies should also be conducted to determine the most suitable plants for the subtropical Australian climate, and the best growing medium make up for our environment. Once these are completed, the most effective eco-roof for the Australian subtropical climate should be able to be developed and implemented to aid in the mitigation of climate change in Australia.

## REFERENCES

- [1] A.A. Chowdhury and M.G. Rasul (2009), Sustainable Solution to the Green Waste Management By Thermo-Chemical Conversion Processes, Proceedings of the Engineering Congress on Alternative Energy Applications: Option or Necessity, Paper ID-1174, Kuwait, 2-6 November, 2009.
- [2] EPA 2008, Heat Island Effect, available from, <http://www.epa.gov/hiri>
- [3] N.H. Wong, Y. Chen, C.L.Ong, A.Sia, Investigation of thermal benefits of rooftop garden in the tropical environment. *Build. Environ.* 38, 2003, pp. 261-270.
- [4] E.C. Snodgrass &L. McIntyre(2010), *The Green Roof Manual: A Professional Guide to Design, Installation, and Maintenance*, Timber Press, Portland.
- [5] Elmich, Sustainable eco-friendly landscapes and architectural products, 2013, available from <http://www.elmich.com>.
- [6] E. Eumorfopoulou&D. Aravantinos (1998), The Contribution of a Planted Roof to the Thermal Protection of Buildings in Greece, *Energy and Buildings*, vol. 27, no. 1, pp. 29-39.
- [7] K. Liu &B. Baskaran(2003), Thermal Performance of Green Roofs Through Field Evaluation, First North American Green Roof Infrastructure Conference, Chicago.
- [8] K. Meier (1991), Strategic Landscaping and Air-conditioning Savings: A Literature Review', *Energy and Buildings*, vol. 15, no. 16, pp478-486.
- [9] Wikipedia 2008, Green Roofs, available from, [http://en.wikipedia.org/wiki/Green\\_roof](http://en.wikipedia.org/wiki/Green_roof).
- [10] Schundler 2013, Green roof at office/ school complex in Germany, available from, [www.schundler.com/greenroofs.htm](http://www.schundler.com/greenroofs.htm)
- [11] Inhabitat 2013, Green roof on California Academy of Sciences, available from, [www.inhabitat.com](http://www.inhabitat.com).
- [12] M. Anwar, M.G. Rasul and M.M.K. Khan (2013), Thermal Performance Analysis of Rooftop Greenery System in subtropical climate of Australia, 7th WSEAS International Conference on Renewable Energy Sources 2013, April 2-4, 2013, Kuala Lumpur, Malaysia.
- [13] T. Theodosiou (2003), Summer Period Analysis of the Performance of a Planted Roof as a Passive Cooling Technique, *Energy and Buildings*, vol. 35, pp909-917.
- [14] S. Frankenstein&G. Koenig (2004), Fast All Season Soil Strength Vegetation Models, U.S. Army Engineer Research and Development Center, ERDC/CRREL Technical Report, TR-05-25, Cold Regions Research and Engineering Laboratory.