

Fuzzy Logic Control for a Speed Control of Induction Motor using Space Vector Pulse Width Modulation

Satean Tunyasrirut, Tianchai Suksri, and Sompong Srilad

Abstract—This paper presents design and implements a voltage source inverter type space vector pulse width modulation (SVPWM) for control a speed of induction motor. This scheme leads to be able to adjust the speed of the motor by control the frequency and amplitude of the stator voltage, the ratio of stator voltage to frequency should be kept constant. The fuzzy logic controller is also introduced to the system for keeping the motor speed to be constant when the load varies. The experimental results in testing the 0.22 kW induction motor from no-load condition to rated condition show the effectiveness of the proposed control scheme.

Keywords—Fuzzy logic control, space vector pulse width modulation, induction motor.

I. INTRODUCTION

THE Space Vector Pulse Width Modulation (SVPWM) method is an advanced, computation-intensive PWM method and possibly the best among all the PWM techniques for variable frequency drive application. Because of its superior performance characteristics, it has been finding widespread application in recent year. The PWM methods discussed so far have only considered implementation on half bridges operated independently, giving satisfactory PWM performance. With a machine load, the load neutral is normally isolated, which causes interaction among the phases. This interaction was not considered before in the PWM discussion [1]-[4]. Recently, Fuzzy logic control has found many applications in the past decade. This is so largely because fuzzy logic control has the capability to control non-linear, uncertain systems even in the case where no mathematical model is available for the controlled system. However, there is no systematic method for designing and tuning the fuzzy logic controller.

Manuscript received November 30, 2006. The research has been supported in part by Faculty of Engineering, Pathumwan Institute of Technology, Bangkok 10330, Thailand.

Satean Tunyasrirut is with Asst. Prof at Department of Instrumentation Engineering, Pathumwan Institute of Technology, Thailand. His research interests include modern control, intelligent control, Power Electronics, Electrical Machine and Drives (e-mail: satean2000@gmail.com)

Tianchai Suksri is with Lecturer at Department of Instrumentation Engineering, Faculty of Engineering, Pathumwan Institute of Technology, Bangkok 10330, Thailand. His research interests include Control Engineering.

Sompong Srilad is with Lecturer at Department of Electrical Engineering, Faculty of Engineering, Pathumwan Institute of Technology, Bangkok 10330, Thailand. His research interests include Electric Drives, Energy Conversion and Electrical Machine (e-mail:sompong@ptwit.ac.th).

This means that if the a reliable expert knowledge is not available or if the controlled system is too complex to derive the required decision rules, development of a fuzzy logic controller become time consuming and tedious or sometimes impossible. In the case that the expert knowledge is available, fine-tuning of the controller might be time consuming as well. Furthermore, an optimal fuzzy logic controller can not be achieved by trial-and-error. These drawbacks have limited the application of fuzzy logic control. Some efforts have been made to solve these problems and simplify the task of tuning parameters and developing rules for the controller. These approaches mainly use adaptation or learning techniques drawn from artificial intelligence or neural network theories. Application of fuzzy logic control for the control a speed induction motor using space vector pulse width modulation is quite new [5].

This paper presents design and implements a voltage source inverter type space vector pulse width modulation for control a speed of induction motor. The paper also introduces a fuzzy logic controller to the SVPWM in order to keep the speed of the motor to be constant when the load varies. The speed motor control system is set up for testing.

The aim of this paper is two-fold. The first is shown the dynamics response of speed with design the fuzzy logic controller to control a speed of motor for keeping the motor speed to be constant when the load varies. The second aim is shown the phase voltage and line current waveforms.

II. INVERTER FOR AC DRIVES

A. Space Vector Pulse Width Modulation

The SVPWM method considers this interaction of the phase and optimizes the harmonic content of the three phase isolated neutral load as shown in Fig. 1.

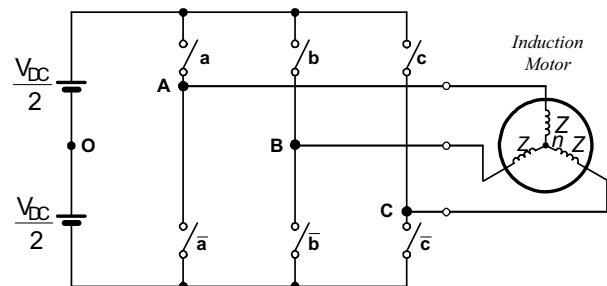

Fig. 1 Voltage source inverter type 3 phase

The three phase sinusoidal and balance voltages given by the equations as follows:

$$V_{An} = V_m \cos \omega t \quad (1)$$

$$V_{Bn} = V_m \cos \left(\omega t - \frac{2\pi}{3} \right) \quad (2)$$

$$V_{Cn} = V_m \cos \left(\omega t + \frac{2\pi}{3} \right) \quad (3)$$

$$\vec{V} = \frac{2}{3} [v_{An} + av_{Bn} + a^2 v_{Cn}] \quad (4)$$

Are applied to the three phase induction motor, using Eq. (4). A three phase bridge inverter, From Fig. 1, has 8 permissible switching states. Table I gives summary of the switching states and the corresponding phase-to-neutral voltage of isolated neutral machine.

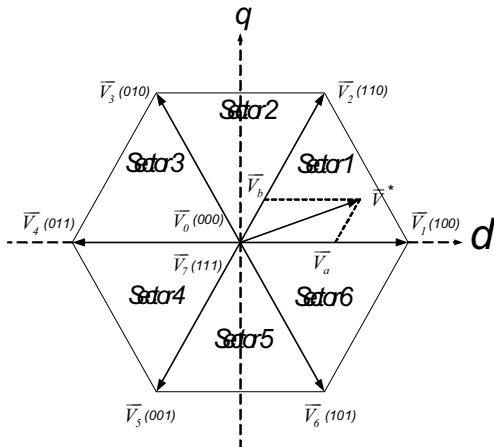

Fig. 2 Space vector of voltage

TABLE I
 SUMMARY OF INVERTER SWITCHING STATES

Name	a	b	c	v_{An}	v_{Bn}	v_{Cn}
V_0	0	0	0	0	0	0
V_1	1	0	0	$2V_{DC}/3$	$-V_{DC}/3$	$-V_{DC}/3$
V_2	1	1	0	$V_{DC}/3$	$V_{DC}/3$	$-2V_{DC}/3$
V_3	0	1	0	$-V_{DC}/3$	$2V_{DC}/3$	$-V_{DC}/3$
V_4	0	1	1	$-2V_{DC}/3$	$V_{DC}/3$	$V_{DC}/3$
V_5	0	0	1	$-V_{DC}/3$	$-V_{DC}/3$	$2V_{DC}/3$
V_6	1	0	1	$V_{DC}/3$	$-2V_{DC}/3$	$V_{DC}/3$
V_7	1	1	1	0	0	0

“0” = Off, “1” = On

Consider, for example state V_2 space vector of voltage (\vec{V}_2) is

$$\vec{V}_2 = \frac{2}{3} \left[\frac{V_{DC}}{3} + a \frac{V_{DC}}{3} - a^2 \frac{2V_{DC}}{3} \right] = \frac{2}{3} V_{DC} \cdot e^{j\frac{\pi}{3}} \quad (5)$$

$$v_{no} = \frac{1}{2} \text{median}(v_{An}, v_{Bn}, v_{Cn}) \quad (6)$$

Double edge modulation of reference voltage v_{Ao} , v_{Bo} and v_{Co} are equal as follows:

$$\begin{aligned} v_{Ao} &= v_{An} + v_{no} \\ v_{Bo} &= v_{Bn} + v_{no} \\ v_{Co} &= v_{Cn} + v_{no} \end{aligned} \quad (7)$$

B. Simulink Implementation

To implement the algorithm in Simulink, we shall first assume that the three-phase voltages at the stator terminals must have the following from Eqs. (1)-(3), the frequency f and the amplitude V_m are variables. However, the V/f control algorithm implies that there is a relationship between the amplitude of the voltage and the frequency, i.e. the ration between the two quantities is constant [2],[3].

$$K = \frac{V_m}{f} \quad (8)$$

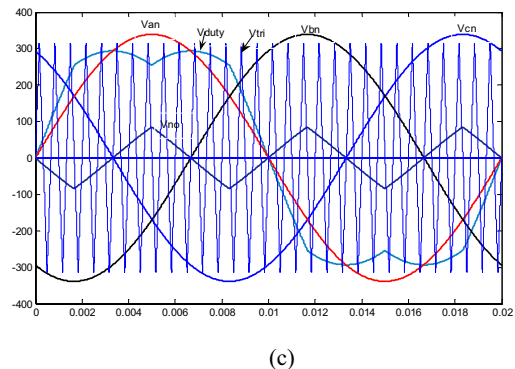
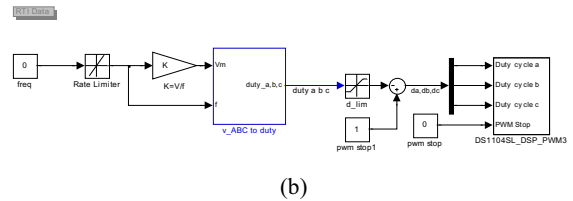
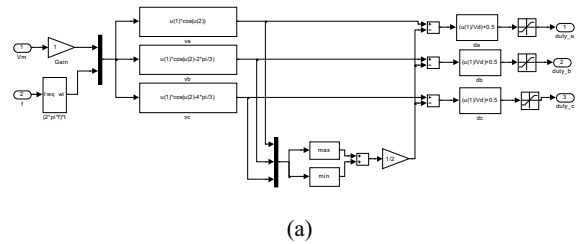

Fig. 3 (a) Simulink implementation of SVPWM, (b) Open loop V/f control, (c) Space Vector Pulse-Width Modulation of V/f

III. DESIGN OF A FUZZY LOGIC CONTROLLER

In drive operation, the speed ω_r can be controlled indirectly by controlling the torque which, for the normal operating region, is directly proportional to the voltage to frequency. The speed is controlled by fuzzy logic controller whose output is the reference current of the inner dc current controller. The torque is controlled by varying the dc current. The drive performance of SVPWM is improved by employing 2 sets of fuzzy logic controllers. From Fig. 4, one set of fuzzy logic controller is used in the inner loop for controlling the torque of the motor which is proportional to DC link current I_{dc} , and another set is used in the outer loop for controlling the actual motor speed ω_r .

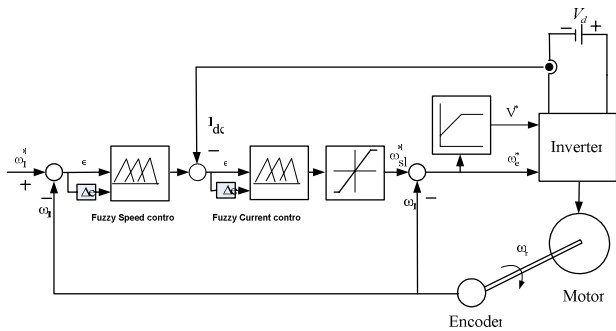

Fig. 4 Block diagram of fuzzy speed and current control

Therefore, the fuzzy logic controllers in the paper will result the higher accuracy in controlling the v/f/F. A fuzzy logic controller is proposed to control the speed of the motor to be constant when the load varies. The speed error $e(k)$ and the change of speed error $ce(k)$ are processed through the fuzzy logic controller whose output is the voltage command I_{dc}^* . The current error is usually processed by current regulator to produce a control frequency ω_c^* . This control frequency adjusts the v/f of SVPWM such that the desired speed of the motor can be obtained. In the design of a fuzzy logic controller, seven membership functions were used for both error and change of error. Membership functions were constructed to represent the input and output value. The fuzzy logic controller consists of three stages: fuzzification, control rules evaluation and defuzzification. Consider the fuzzy speed control system, where the input signal are e and ce and the output signal is du , as explained before. Fig. 5 shows the fuzzy sets and corresponding triangular MF description of each signal. The fuzzy sets are as follows: Z = Zero, PB = Positive Big, NB = Negative Big, PS = Positive Small, NS = Negative Small, NVS = Negative Very Small, PM = Positive Medium NM = Negative Medium, PVS = Positive Very Small [6].

The universe of discourse of all the variables, covering the whole region, is expressed in per unit values. All the MFs are asymmetrical because near the origin, the signals require more precision. There are seven MFs for $e(pu)$ and $ce(pu)$ signal, whereas there are nine MFs for the output. All the MFs are symmetrical for positive and negative values of the variables. Fig. 6 shows the corresponding rule table for the speed controller. The top

row and left column of the matrix indicate the fuzzy sets of the variables e and ce , respectively, and the MFs of the output variable $du(pu)$ are shown in the body of the matrix. There may be $7*7 = 49$ possible rules in the matrix, where a typical rule reads as:

IF $e(pu)$ is PS AND $ce(pu)$ is NM THEN $du(pu)$ is NS. Some blocks in the rule table may remain vacant, giving less number of rules

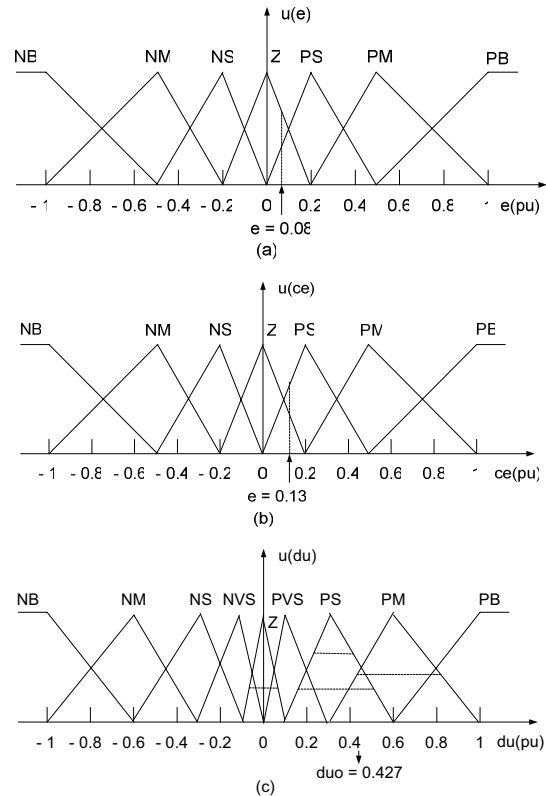

Fig. 5 Membership functions

$ce(pu) \backslash e(pu)$	NB	NM	NS	Z	PS	PV	PE
NB	NVE	NVE	NVE	NB	NM	NS	Z
NM	NVE	NVE	NB	NM	NS	Z	PS
NS	NVE	NB	NM	NS	Z	PS	PV
Z	NB	NM	NS	Z	PS	PV	PB
PS	NM	NS	Z	PS	PV	PB	PVB
PV	NS	Z	PS	PV	PB	PVB	PVB
PB	Z	PS	PV	PB	PVB	PVB	PVB

Fig. 6 Rule base of fuzzy speed and current control

IV. EXPERIMENTAL SETUP

The experimental set-up, illustrated in Fig. 7, implemented to a three phase induction motor which has the detail as

follows: 0.22 kW, 230/400V, 1.03/0.59 A, 50Hz, P.F 0.8 lag and 1410 rpm. The speed of motor ranging from 0 to 1500 rpm is measured by incremental encoder 3600 pulse/rev. All current and voltage are measured using LEM sensors, and both of them are then transformed to be a voltage ranging from 0 to ± 10 volts which will be the input of A/D respectively. This scheme enables the user to adjust the speed of the motor by the duty cycle of the V/F operating in SVPWM mode. The performances of a linear control technique implemented on a fuzzy logic controller to control speed of motor using dSPACE the real-time DS1104'TMS3204 DSP Controller Board along with the Matlab/Simulink tool with sampling time 1 ms as shown in Fig. 7 [7]-[11].

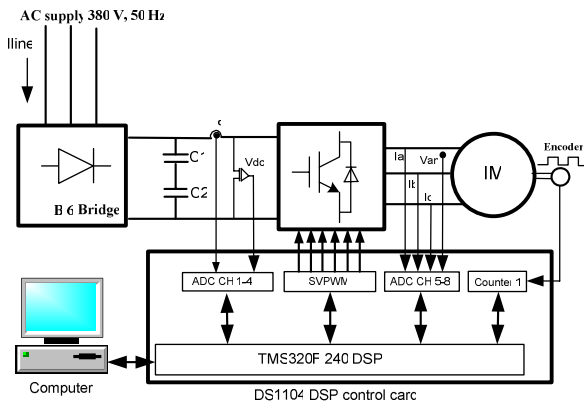

Fig. 7 Experimental setup

V. RESULTS AND DISCUSSIONS

A. Step Response of Speed

To evaluate the performance of the system, a series of measurements has been accomplished. The measurements can be divided in two groups: the first is a step change of the speed reference at constant load torque and the second is a step change of the load torque at constant speed reference. Figs. 8-9 as shown performance of the fuzzy logic controller with a fuzzy tuning rule based on step response of speed control. To be tested time response of speed, duty cycle and line current via the step change of speed reference 300 to 1200 rpm with the load torque equal to zero and equal to rated respectively. Figs. 10-11 as shown time response of speed, duty cycle and line current via the step change of the load torque at constant speed reference 600 and 1200 rpm respectively.

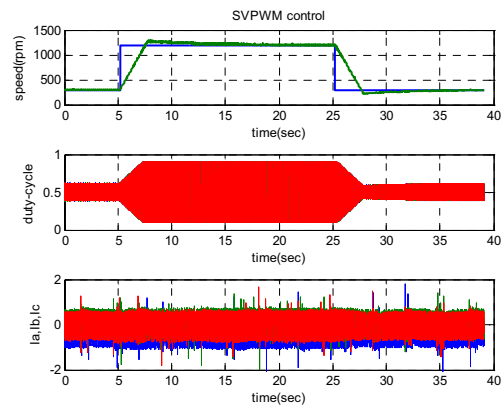

Fig. 8 Step change of speed reference 300-1200 rpm at zero load

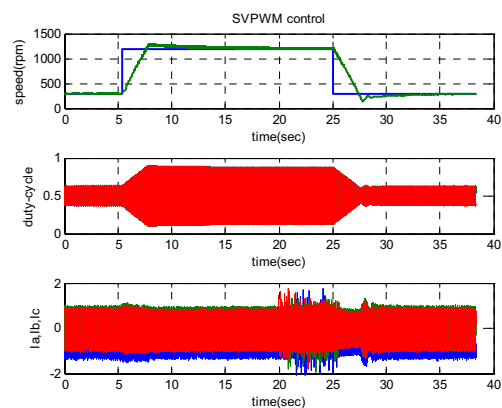

Fig. 9 Step change of speed reference 300-1200 rpm at rated load

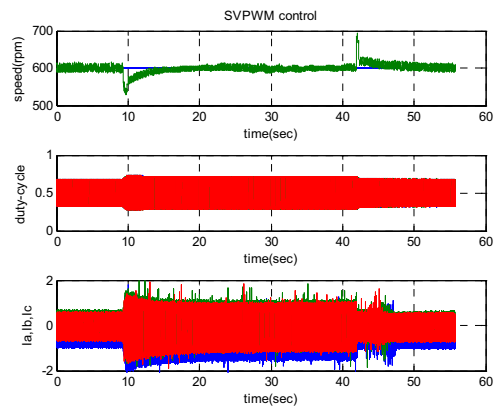

Fig. 10 Step change of load torque at constant speed reference 600 rpm

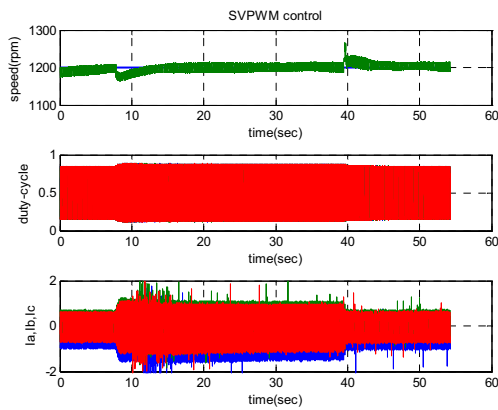

Fig. 11 Step change of load torque at constant speed reference 1200 rpm

From the results tested the performance of controller by a step change of the speed reference at constant load torque as shown in Figs. 8-9, it's found that the Rise time $t_r = 2$ s, Peak time $t_p = 3$ s, Settling time $t_s = 15$ s, Maximum overshoot $M_p = 12\%$ and a step change of the load torque at constant speed reference as shown in Figs. 10-11, it's found that the Settling time $t_s = 15$ s. From the experimental results obtained, the proposed fuzzy logic controller can keep the motor speed to be constant at the speed ranging from 300 to 1200 rpm.

Figs. 12-14 as shown steady state error of speed at reference speed 300, 600 and 1200 rpm rated load respectively. It's found that it have state error ± 10 rpm.

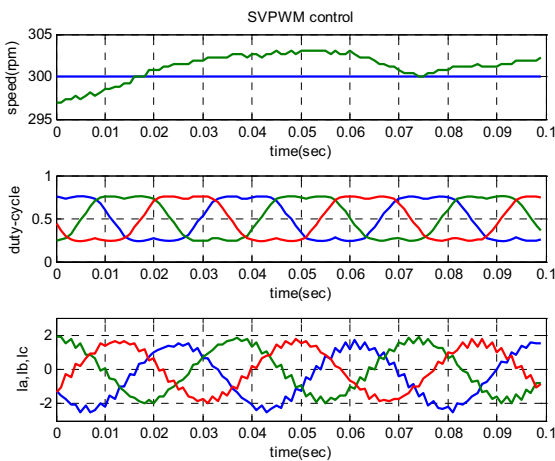

Fig. 12 Steady state error of speed reference 300 rpm at rated load

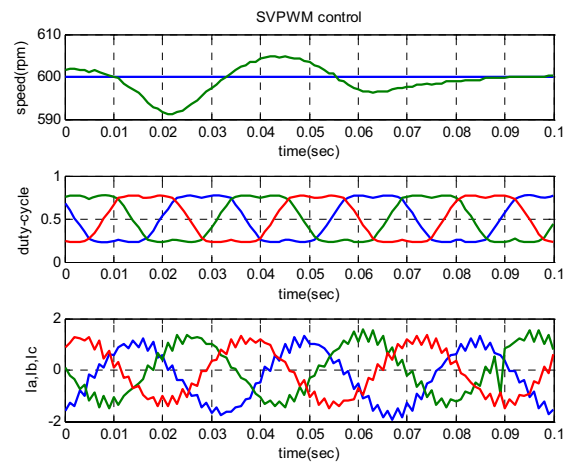

Fig. 13 Steady state error of speed reference 600 rpm at rated load

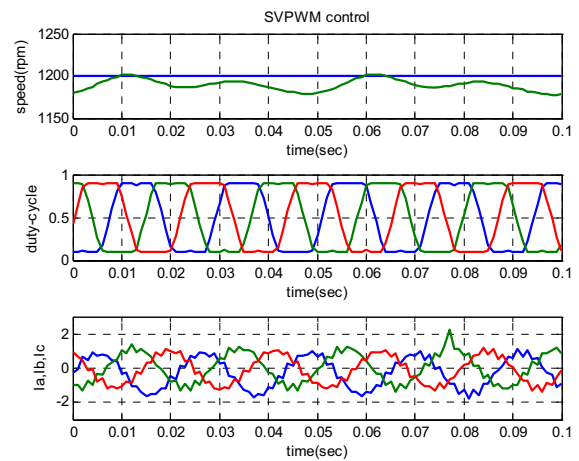

Fig. 14 Steady state error of speed reference 1200 rpm at rated load

B. The Phase Voltage and Input Line Current Waveforms

The line voltage and line current are measured; they are measured by using LEM sensors with ratio Amp/volt and ratio 100 V/volt. All data of signal are kept on of digital storage oscilloscope. The waveforms of SVPWM, phase voltage V_{an} and line current I_a are measured digital storage oscilloscope as shown in Figs. 15-20.

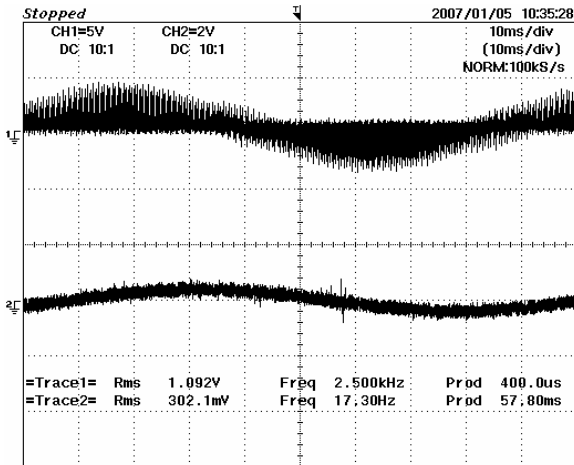

Fig. 15 V_{an} and I_a at speed 300 rpm zero load

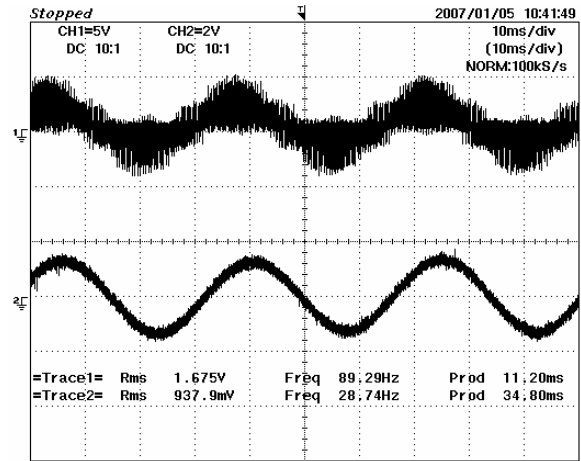

Fig. 18 V_{an} and I_a at speed 600 rpm rated load

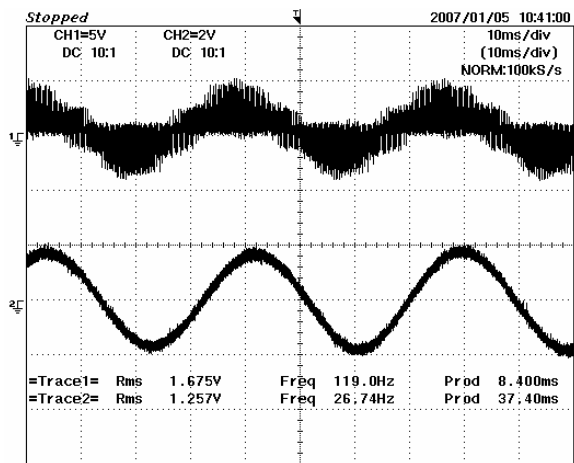

Fig. 16 V_{an} and I_a at speed 300 rpm rated load

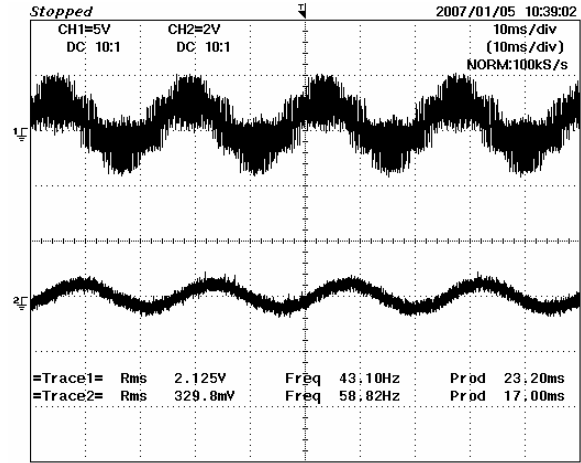

Fig. 19 V_{an} and I_a at speed 1200 rpm zero load

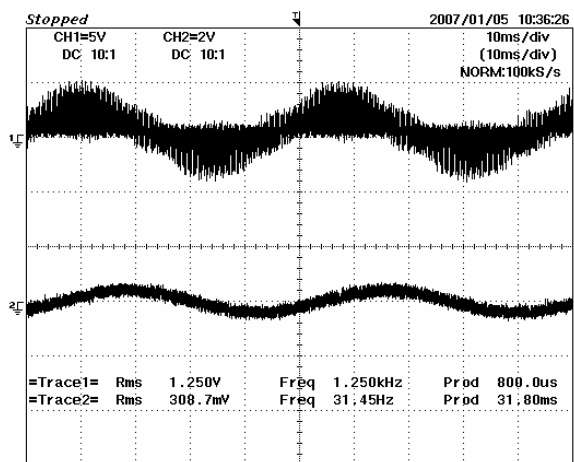

Fig. 17 V_{an} and I_a at speed 600 rpm zero load

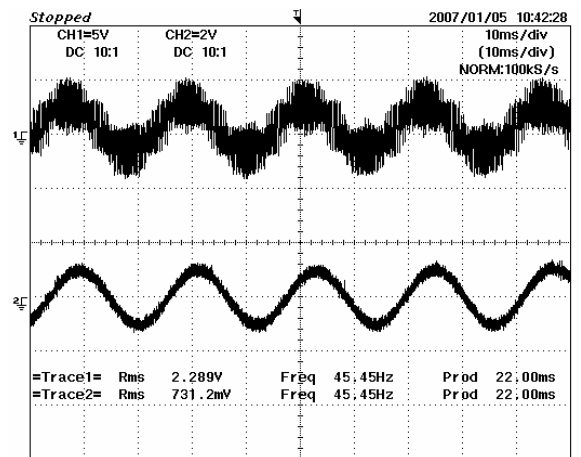

Fig. 20 V_{an} and I_a at speed 1200 rpm rated load

VI. CONCLUSION

The Fuzzy logic controller is applied to speed signal model of motor and is then downloaded to dSPACE through Simulink. The experimental results are analyzed in testing the 0.22 kW induction motor from zero load condition to rated condition, it's found that the speed of the induction motor can be controlled. In addition, the motor speed to be constant when the load varies.

ACKNOWLEDGMENT

The authors gratefully thank the financial support from Faculty of Engineering, Pathumwan Institute of Technology, Bangkok 10330, Thailand.

REFERENCES

- [1] Andrzej M. Trzynadlowski, Introduction to Modern Power Electronics, Copyright© 1998 by John Wiley & Sons, Inc. All rights reserved.
- [2] Bimal K.Bose, Modern Power Electronics and AC Drives, © 2002 Prentice Hall PTR.
- [3] W. Leonham, Control of Electrical Drives, Springer-Verlag Berlin Heidelberg, New York, Tokyo, 1985.
- [4] F. Ashrafzadeht, E.P. Nowickit, and J.C. Samont, "A Self-Organizing and Self-Tuning Fuzzy Logic Controller for Field Oriented Control of Induction Motor Drives", 0-7803-3008-0/95 \$4.00© 1995 IEEE, pp. 1656-1662.
- [5] Zdenko Kovaccic and Stjepan Bogdan, Fuzzy Controller design Theory and Applications, © 2006 by Taylor & Francis Group. International, 2002.
- [6] Hoang Le-Huy and Maher Hamdi, "Control of Direct-Drive DC Motor by Fuzzy Logic", 0-7803-1462-x/93\$03.00 © 1993 IEEE, pp. 732-738.
- [7] DSP Based Electric Drives Laboratory User Manual, Frequency Control of AC-Motor Drives, Department of Electrical and Computer Engineering University of Minnesota.
- [8] University of Minnesota, Introduction Getting Started with dSPACE, DSP Based Laboratory of Electric Drives.
- [9] Katsuhiko Ogata ,Modern Control Engineering Fourth Edition, Prentice Hall International, 2002.
- [10] Satean Tunyasrirut, "Implementation of a dSPACE-based Digital State Feedback Controller for a Speed Control of Wound Rotor Induction Motor",0-7803-9484-4/05/\$20.00©2005 IEEE, pp.11981203.
- [11] Control Desk Experiment Guide, dSPACE, May 2002.



Satean Tunyasrirut received in B.S.I.Ed. in Electrical Engineering and M.S.Tech.Ed in Electrical Technology from King Mongkut's Institute of Technology North Bangkok(KMITNB),Thailand in 1986 and 1994, respectively. In 1995 he was awarded with the Japan International Cooperation Agency (JICA) scholarship for training the Industrial Robotics at Kumamoto National College of Technology, Japan. Since 1995, he has been a Asst. Prof at Department of Instrumentation Engineering, Pathumwan Institute of Technology, Thailand. His research interests include adaptive control, intelligent control, electric drives.



Tianchai Suksri received in B.Eng. and M.Eng in Instrumentation Engineering from King Mongkut's Institute of Technology Ladkrabang (KMITL),Thailand in 2001 and 2004, respectively. He is with Lecturer at Department of Instrumentation Engineering, Faculty of Engineering, Pathumwan Institute of Technology, Bangkok 10330, Thailand. His research interests include Control system, intelligent control.



Sompong Srilad received in B.S.I.Ed., B.Eng in Electrical Engineering and M.S.Tech.Ed in Electrical Technology from King Mongkut's Institute of Technology North Bangkok(KMITNB),Thailand in 1976 and 1996, respectively. He is with Lecturer at Department of Electrical Engineering, Faculty of Engineering, Pathumwan Institute of Technology, Bangkok 10330, Thailand. His research interests include Electric Drives, Energy Conversion and Electical Machine.