

Fuzzy Control of Macroeconomic Models

André A. Keller

Abstract—The optimal control is one of the possible controllers for a dynamic system, having a linear quadratic regulator and using the Pontryagin's principle or the dynamic programming method. Stochastic disturbances may affect the coefficients (multiplicative disturbances) or the equations (additive disturbances), provided that the shocks are not too great. Nevertheless, this approach encounters difficulties when uncertainties are very important or when the probability calculus is of no help with very imprecise data. The fuzzy logic contributes to a pragmatic solution of such a problem since it operates on fuzzy numbers. A fuzzy controller acts as an artificial decision maker that operates in a closed-loop system in real time. This contribution seeks to explore the tracking problem and control of dynamic macroeconomic models using a fuzzy learning algorithm. A two inputs - single output (TISO) fuzzy model is applied to the linear fluctuation model of Phillips and to the nonlinear growth model of Goodwin.

Keywords—fuzzy control, macroeconomic model, multiplier - accelerator, nonlinear accelerator, stabilization policy.

I. INTRODUCTION

A Macroeconomic model attempts to describe the dynamics of an economy over short- and long-run time periods. The model consists of differential or difference equations, where the variables are of three main types : (1) endogenous variables that describe the state of the economy,(2) control variables that are the instruments of economic policy to guide the trajectory towards an equilibrium target, and (3) exogenous variables that describe an uncontrollable environment. Given the sequence of exogenous variables, the dynamic optimal stabilization problem consists in finding a sequence of controls, so as to minimize some quadratic objective function [27][28]. The optimal control is one of the possible controllers for a dynamic system, having a linear quadratic regulator and using the Pontryagin's principle or the dynamic programming method [10][19]. Stochastic disturbances may affect the coefficients (multiplicative disturbances) or the equations (additive random term), provided that the shocks are not too great [4][6][33]. Nevertheless, this approach encounters difficulties when uncertainties are very important or when the probability calculus is of no help with very imprecise data. The fuzzy logic contributes to a pragmatic solution of such a problem since it operates on fuzzy numbers. Lee[23] surveys the fuzzy logic on control systems : methodology of constructing the fuzzy logic controller (FLC), its performances, the fuzzification and defuzzification strategies, the derivation of the data base and control rules, the definition of fuzzy implication and analysis of fuzzy reasoning mechanisms. The modeling controllers using fuzzy relations is presented with applications in [5][12][21][22][31][36] [37]. Afshari and Georgescu [1] develop a single input-single output (SISO) fuzzy model for

André A. Keller is with the Université de Haute Alsace, Mulhouse (France), email: andre.keller@uha.fr

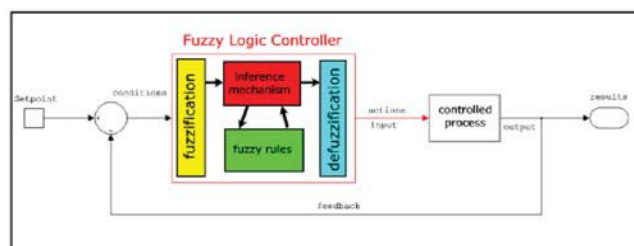

Fig. 1. Design the fuzzy controller

the design of optimal tracking control systems (a particular class of quadratic control). The experimental results indicate often better performances of the FLC than the conventional PID controller and show its use to engineering problems [7]. In a fuzzy logic, the logical variables take continue values between 0(false) and 1(true), while the classical Boolean logic operates on binary values of either 0 or 1. Fuzzy sets are then a natural extension of crisp sets. The most common shape of their membership functions is triangular or trapezoidal. This contribution seeks to explore the control of dynamic macroeconomic models using a fuzzy learning algorithm. Two basic multiplier-accelerator models for a closed economy are considered : the linear fluctuation model of Phillips [2][3][25][26]and the nonlinear growth model of Goodwin [2][15][17]. The computations are carried out using the packages *MATHEMATICA*'s FuzzyLogic 2 [20][30][35], *MATLAB* R2008a & Simulink 7, & Control Systems, & Fuzzy Logic 2 [32].

II. FUZZY MODELING AND CONTROL

A. Fuzzy modeling

1) *Fuzzy logic controller*: A FLC acts as an artificial decision maker that operates in a closed-loop system in real time[24]. Fig.1 shows a simple control problem, keeping a desired value of a single variable. There are two conditions : the error and the derivative of the error. This controller has four components : (1) a fuzzification interface to convert crisp input data into fuzzy values, (2) a static set of "If-Then" control rules which represents the quantification of the expert's linguistic evaluation of how to achieve a good control, (3) a dynamic inference mechanism to evaluate which control rules are relevant, and (4) the defuzzification interface that converts the fuzzy conclusions into crisp inputs of the process¹. These are the actions taken by the FLC. The process consists of three

¹The commonly used centroid method will take the center of mass. It favors the rule with the output of greatest area. The height method takes the value of the biggest contributor.

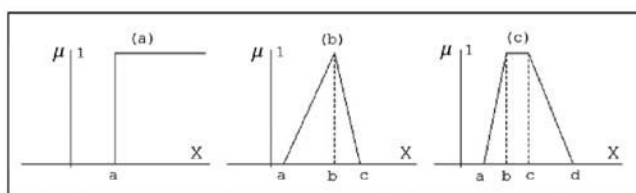

Fig. 2. (a) Crisp set, (b) Triangular MF, (c) Trapezoidal MF

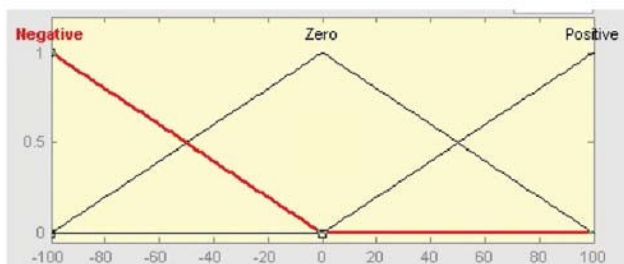

Fig. 3. Membership functions of the two inputs and one output

main stages : at the input stage (1) the inputs are mapped to appropriate functions, at the processing stage (2) appropriate rules are used and the results are combined, at the output stage (3) the combined results are converted to a crisp value input for the process.

2) Fuzzification:

a) *Membership functions:* A membership function (MF) assigns to each element x of the universe of discourse X , a grade of membership $\mu(x)$, such that $\mu : X \mapsto [0, 1]$. The Fig.2 compares the crisp number to commonly used linear pieewise shapes : a triangular-shaped MF and a trapezoidal-shaped MF ². The triangular MF is defined by $\mu(x) = \max\left\{\min\left\{\frac{x-a}{b-a}, \frac{c-x}{c-b}\right\}, 0\right\}$, where $a < b < c$. The trapezoidal MF is defined by $\max\left\{\min\left\{\frac{x-a}{b-a}, 1, \frac{d-x}{d-c}\right\}, 0\right\}$, where $a < b < c < d$. A fuzzy set \tilde{A} is then defined as a set of ordered pairs $\tilde{A} = \{x, \mu_{\tilde{A}}(x) | x \in X\}$. According to the fuzzy Zadeh operators, we have : $\mu(\tilde{A} \wedge \tilde{B}) = \min\{\mu(\tilde{A}), \mu(\tilde{B})\}$, $\mu(\tilde{A} \vee \tilde{B}) = \max\{\mu(\tilde{A}), \mu(\tilde{B})\}$ and $\mu(\neg\tilde{A}) = 1 - \mu(\tilde{A})$. The overlapping MFs of the two inputs error and change-in-error and the MF of the output control-action show the most common triangular form in figure 3. The linguistic label of these MFs are "Negative", "Zero" and "Positive" over the range $[-100, 100]$ for the two inputs and over the range $[-1, 1]$ for the output.

²A smooth representation (π -curve) may be obtained using s- and z-curves. The s-curve is defined by $s(x; a, b) = \begin{cases} 0, & \text{if } x < a, \\ \frac{1}{2}(1 + \cos \frac{x-b}{b-a}\pi), & \text{if } a \leq x \leq b, \\ 1 & \text{if } x > b \end{cases}$ and by $z(x; b, c) = \begin{cases} 0, & \text{if } x < b, \\ \frac{1}{2}(1 + \cos \frac{x-b}{c-b}\pi), & \text{if } b \leq x \leq c, \\ 1 & \text{if } x > c \end{cases}$. The π -curve is then $\pi((x; a, b, c)) = \min\{s(x; a, b), z(x; b, c)\}$.

		change in error		
control action		NL	ZE	PL
error	NL	NL ¹	ZE ²	ZE ³
	ZE	ZE ⁴	ZE ⁵	PL ⁶
	PL	ZE ⁷	PL ⁸	PL ⁹

Fig. 4. Fuzzy rule base 1:NL-Negative Large, ZE-Zero error,PL-Positive Large

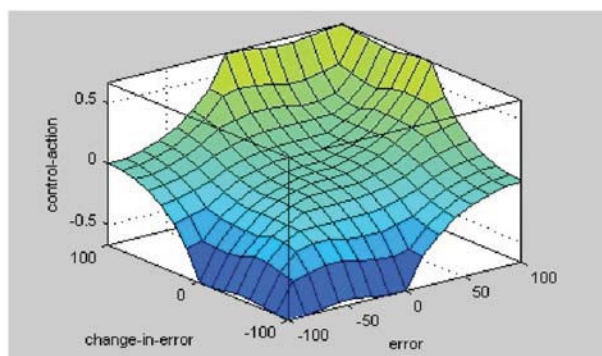

Fig. 5. Fuzzy surface

b) *Fuzzy rules:* Fuzzy rules are coming from expert knowledge and consist of "If-Then" statements. The linguistic rules consist of an antecedent block between "If" and "Then" and a consequent block following "Then" ³. Let the continuous differentiable variables $e(t)$ and $\dot{e}(t)$ denote the error and the derivative of error in the simple stabilization problem of Fig. 1. The conditional recommendations are of the type

If $\langle e, \dot{e} \rangle$ is $A \times B$ **Then** v is C , where $[A \times B](x, y) = \min[A(x), B(y)]$, $x \in [-a, a]$, $y \in [-b, b]$.

These FAM(Fuzzy Associative Memory)-rules ⁴are those of the Fig.4. The commonly linguistic states of the TISO model are denoted by the simple linguistic set $A = \{NL, ZE, PL\}$. The binary input-output FAM-rules are then triples such as $(NL, NL; NL)$: "If" input e is Negative Large and \dot{e} is Negative Large "Then" control action v is Negative Large. The antecedent (input) fuzzy sets are implicitly combined with conjunction "And". The control surface of this TISO control strategy is given by Fig.5

c) *Fuzzy inference:* In Fig.6, the system combines logically input crisp values with minimum, since the conjunction "And" is used. Fig.7 produces the output set, combining all the

³See Braae and Rutherford [7] for fuzzy relations in a FLC and their influences to select more appropriate operations.

⁴Choosing an appropriate dimension of the rule sets is discussed by Chopra and al.[11]. The compared rules bases dimension 9(for 3 MFs), 25 (5 MFs), 49 (7 MFs), 81 (9 MFs) and 121 (11 MFs).

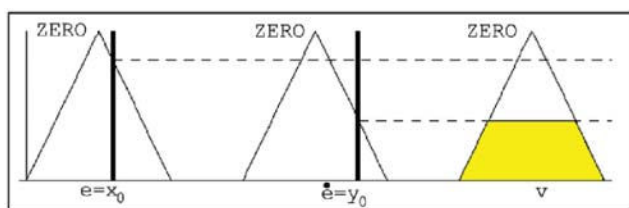

Fig. 6. FAM influence procedure with crisp input measurements

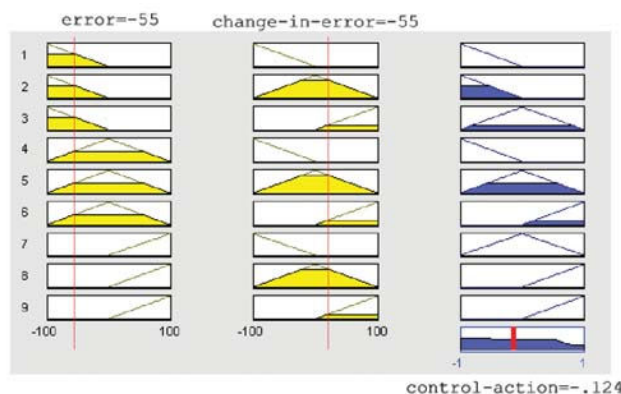

Fig. 7. Output fuzzy set from crisp input measurements

rules of the simple control example, given crisp input values of the pair (e, \dot{e}) .

3) *Defuzzification*: The fuzzy output for all rules are aggregated to a fuzzy set as in Fig.7. Several methods can be used to convert the output fuzzy set into a crisp value for the control-action variable v . The centroid method (or center of gravity (COG) method) is the center of mass of the area under the graph of the MF of the output set in Fig.7. The COG corresponds the expected value

$$v_c = \frac{\int v \mu(v) dv}{\int \mu(v) dv}$$

In this example, $v_c = -.124$ for the pair of crisp inputs $(e, \dot{e}) = (-55, 20)$.

B. TISO Mamdani fuzzy controller

Let us consider the simple control example. The fuzzy controller uses identical input fuzzy sets, namely "Negative", "Zero" and "Positive" MFs. Fig.8 uses the 9 numbered fuzzy rules of Fig.4. Let suppose the system output to follow

$$x(t) = 4 + e^{-t/5}(-4 \cos t + 3\sqrt{6} \sin t)$$

The error is defined by $e(t) = r(t) - x(t)$, where $r(t)$ is the reference input, supposed to be constant (a setpoint)⁵. Then we have $\frac{d}{dt}e(t) = \dot{e} = -\dot{x}$. These nine rules will cover all the possible situation. According to rule 1 ($NL, NL; NL$), the system output is above the setpoint (negative error) and is increasing at this point. The controller output should then be

⁵Scaling factors may be used to modify easily the universe of discourse of inputs. We then have the scaled inputs $K_e e(t)$ and $K_r \dot{e}(t)$

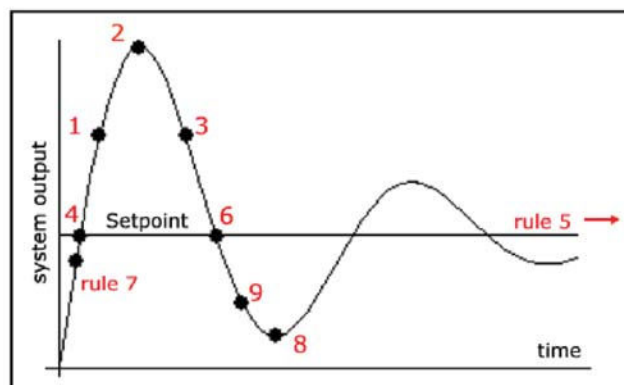

Fig. 8. System output and fuzzy rules

increased. On the contrary, according to rule 9 ($PL, PL; PL$), the system output is below the setpoint (positive error) and is decreasing at this point. The controller output should then be decreased.

III. APPLICATION TO ECONOMICS

Stabilization problem are considered with time-continuous multiplier-accelerator models: the linear Phillips fluctuation model and the nonlinear Goodwin growth model⁶.

A. The linear Phillips model

1) *Presentation*: The equations of the Phillips' model [2][16][25][26][29] are

$$Z(t) = C(t) + I(t) + G(t), \quad (1)$$

$$C(t) = c.Y(t) - u(t), \quad (2)$$

$$\frac{dI(t)}{dt} = -\beta \left(I(t) - v \frac{dY(t)}{dt} \right), \quad (3)$$

$$\frac{dY(t)}{dt} = -\alpha \left(Y(t) - Z(t) \right). \quad (4)$$

All yearly variables are continuous twice-differentiable functions of time and all measured in deviation from the initial equilibrium value. The aggregate demand Z consists of consumption C , investment I and autonomous expenditures of government G in (1). Consumption C depends on income Y without delay and is disturbed by a spontaneous change u at time $t = 0$ in (2). The variable $u(t)$ is then defined by the step function $u(t) = 0$, for $t < 0$ and $u(t) = 1$ for $t \geq 1$. The coefficient c is the marginal propensity to consume. The equation (3) is the linear accelerator of investment, where investment is related to the variation in demand. The coefficient v is the acceleration coefficient and β denotes the speed of response of investment to changes in production, the time constant of the acceleration lag being $\frac{1}{\beta}$ years. The equation (4) describes a continuous gradual production adjustment to demand. The rate of change of production Y at any time is proportional to the difference between demand and production

⁶The use of closed-loop theory in economics is due to Tustin[34].

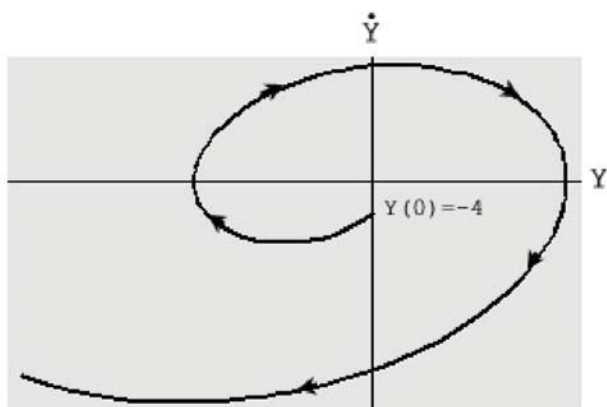

Fig. 9. Phase diagram of the Phillips' model

at that time. The coefficient α is the speed of response of production to changes in demand. Simple exponential time lags are then used in this model.⁷

2) *Dynamics of the unregulated model:* The unregulated model (with $G = 0$ and $u = 1$) is governed by the linear second-order differential equation in Y

$$\ddot{Y} + \left(\alpha(1-c) + \beta - \alpha\beta v \right) \dot{Y} + \alpha\beta(1-c)Y(t) = -\alpha\beta,$$

when $t > 0$ with the initial conditions $Y(0) = 0, \dot{Y}(0) = -\alpha$. Taking the following values for the parameters : $c = \frac{3}{4}, v = \frac{3}{5}, \alpha = 4$ ($T = \frac{1}{\alpha} = 3$ months) and $\beta = 1$ (time constant of the lag 1 year), the differential equation is

$$5\ddot{Y} - 2\dot{Y} + 5Y(t) = -20, t > 0,$$

with initial conditions $Y(0) = 0, \dot{Y}(0) = -4$. The solution of the unregulated model is

$$Y(t) = -4 + 2e^{t/5} \left(2\cos\frac{2\sqrt{6}}{5} - \sqrt{6}\sin\frac{2\sqrt{6}}{5} \right), t > 0$$

or

$$Y(t) = -4 + 6.32e^{t/5} \cos(0.98t + 0.89), t > 0.$$

The graph of $Y(t)$ is plotted in Fig.10(a). The phase diagram in Fig.9 shows an unstable equilibrium which justifies stabilization policies.

3) *Proportional+ Integral+ Derivative Stabilization policies:* The stabilization of the model proposed by Phillips [25] consists of three additive policies : the proportional P-stabilization policy, the proportional+integral PI-stabilization policy, the proportional+integral+derivative PID-stabilization policy. Modifications are introduced by adding terms to the

⁷The differential form of the delay is the production lag $\frac{\alpha}{D+\lambda}$ where the operator D is the differentiation w.r.t time. The distribution form is

$$Y(t) = \int_{\tau=0}^{\infty} w(\tau)Z(t-\tau)d\tau,$$

given by the weighting function $w(t) = \alpha e^{-\alpha t}$. The response function is $F(t) = 1 - e^{-\alpha t}$ for the path of Y following a unit step-change in Z .

consumption equation (2). For a P-stabilization, the consumption equation will be

$$C(t) = c.Y(t) - u(t) - \frac{\lambda}{D+\lambda}K_pY(t),$$

where K_p denotes the proportional correction factor and λ the speed of response of policy demand to changes in potential policy demand⁸. In the numerical applications, we will retain $\lambda = 2$ (a correction lag with time constant of 6 months). The dynamic equation of the model is a linear third-order differential equation in Y . We have

$$Y^{(3)} + \left(\alpha(1-c) + \beta + \lambda - \alpha\beta v \right) \ddot{Y} + \left(\beta\lambda + (1-c)\alpha(\beta + \lambda) + \alpha\lambda K_p - \alpha\beta\lambda v \right) \dot{Y} + \alpha\beta\lambda \left(1 - c + K_p \right) Y(t) = -\alpha\beta\lambda u(t).$$

Taking $c = \frac{3}{4}, v = \frac{3}{5}, \alpha = 4, \beta = 1, \lambda = 2, K_p = 2, u = 1$, the differential equation is

$$5Y^{(3)} + 8\ddot{Y} + 81\dot{Y} + 90Y(t) = -40, t > 0,$$

with initial conditions $Y(0) = 0, \dot{Y}(0) = -4, \ddot{Y}(0) = -5.6$. The solution (for $tt > 0$) is

$$Y(t) = -.44 - .03e^{-1.15t} - 1.1e^{-.23t} \sin(-3.96t + .44)$$

The graph of the P-controlled $Y(t)$ is plotted in Fig.10(b). The system is stable according to the Routh-Hurwitz stability conditions.⁹ Moreover, the stability conditions for K_p are $K_p \leq -0.25$ and $K_p \geq 0.35$.

For a PI-stabilization policy, the consumption equation (2) will be

$$C(t) = c.Y(t) - u(t) - \frac{\lambda}{D+\lambda} \left\{ K_p Y(t) + K_i \int Y(t)dt \right\},$$

where K_i denotes the integral correction factor. The dynamic equation of the model is a linear fourth-order differential equation in Y . We have

$$Y^{(4)} + \left(\alpha(1-c) + \beta + \lambda - \alpha\beta v \right) Y^{(3)} + \left(\alpha(1-c)(\beta + \lambda) + \beta\lambda + \alpha\lambda K_p - \alpha\beta\lambda v \right) \ddot{Y} + \left(\alpha\beta\lambda(1-c) + \alpha\beta\lambda K_p + \alpha\lambda K_i \right) \dot{Y}(t) + \alpha\beta\lambda K_i Y(t) = 0.$$

⁸The time constant of the correction lag is $\frac{1}{\lambda}$ years.

⁹Let be the polynomial equation with real coefficients

$$a_0\lambda^n + a_1\lambda^{n-1} + \dots + a_{n-1}\lambda + a_n = 0, (a_0 > 0).$$

The Routh-Hurwitz theorem states that necessary and sufficient conditions to have negative real part are given by the conditions that all the leading principal minors of a matrix must be positive. In this case, the 3×3 matrix is

$$\begin{pmatrix} a_1 & a_3 & 0 \\ a_0 & a_2 & 0 \\ 0 & a_1 & a_3 \end{pmatrix}.$$

We have all the positive leading principal minors : $\Delta_1 = 1, \Delta_2 = 7.9$ and $\Delta_3 = 142.5$.

Taking $c = \frac{3}{4}$, $v = \frac{3}{5}$, $\alpha = 4$, $\beta = 1$, $\lambda = 2$, $K_p = K_i = 2$, $u = 1$, the differential equation is

$$5Y^{(4)} + 8Y^{(3)} + 81\ddot{Y} + 170\dot{Y} + 80Y(t) = 0, \quad t > 0,$$

with initial conditions $Y(0) = 0$, $\dot{Y}(0) = -4$, $\ddot{Y}(0) = -5.6$, $Y^{(3)}(0) = 96$. The solution (for $t > 0$) is

$$Y(t) = -.07e^{-1.43t} - .13e^{-.69t} + 1.08e^{.26t} \sin(-4.03t + .19).$$

The graph of the PI-controlled $Y(t)$ is plotted in Fig.10(c). The system is unstable, since the Routh-Hurwitz conditions are not all satisfied¹⁰. Given $K_p = 2$, the stability conditions on K_i are $K_i \in [0, .8987]$.

For a PID-stabilization policy, the consumption equation (2) will be

$$C(t) = c.Y(t) - u(t) - \frac{\lambda}{D + \lambda} \left\{ K_p Y(t) + K_i \int Y(t) dt + K_d DY(t) \right\}, \quad (5)$$

where K_d denotes the derivative correction factor. The dynamic equation of the model is a linear fourth-order differential equation in Y . We have

$$Y^{(4)} + \left(\alpha(1 - c) + \beta + \lambda + \alpha\lambda K_d - \alpha\beta v \right) Y^{(3)} + \left((1 - c + \lambda K_d - \lambda v)\alpha\beta + (1 - c + K_p)\alpha\lambda + \beta\lambda \right) \ddot{Y} + \left(\alpha\beta\lambda(1 - c + K_p) + \alpha\lambda K_i \right) \dot{Y} + \alpha\beta\lambda K_i Y(t) = 0.$$

Taking $c = \frac{3}{4}$, $v = \frac{3}{5}$, $\alpha = 4$, $\beta = 1$, $\lambda = 2$, $K_p = K_i = 2$, $K_d = .55$, $u = 1$, the differential equation is

$$Y^{(4)} + 6Y^{(3)} + 20.6\ddot{Y} + 34\dot{Y} + 16Y(t) = 0, \quad t > 0,$$

with initial conditions $Y(0) = 0$, $\dot{Y}(0) = -4$, $\ddot{Y}(0) = 12$, $Y^{(3)}(0) = 2.4$. The solution (for $t > 0$) is

$$Y(t) = -.07e^{-2.16t} - .12e^{-.74t} + 1.40e^{-1.55t} \cos(2.76t + 1.54)$$

The graph of the PID-controlled $Y(t)$ is plotted in Fig.10(d). The system is stable, since the Routh-Hurwitz conditions are all satisfied¹¹. Given $K_p = K_i = 2$, the stability conditions on K_d are $K_d < -3.92$ and $K_d \geq .07$. The Fig.10 illustrates and compares the results. The curve without stabilization policy shows the response of the activity Y to the unit initial decrease of demand. The acceleration coefficient ($v = .8$) generates explosive fluctuations¹². The proportional tuning corrects the level of production but not the oscillations. The oscillations grow worse by the integral tuning. The combined PI-stabilization¹³ renders the system unstable. The additional derivative stabilization is then introduced and the combined PID-policy stabilize the system.

¹⁰We have the leading principal minors : $\Delta_1 = 1$, $\Delta_2 = -8.0$, $\Delta_3 = -274.7$ and $\Delta_4 = -5050.8$.

¹¹We have the leading principal minors : $\Delta_1 = 1$, $\Delta_2 = 89.6$, $\Delta_3 = 3046.4$ and $\Delta_4 = 39526.4$.

¹²Damped oscillations are obtained when the acceleration coefficient lies in the interval $[0, .5]$.

¹³The integral correction is rarely used alone.

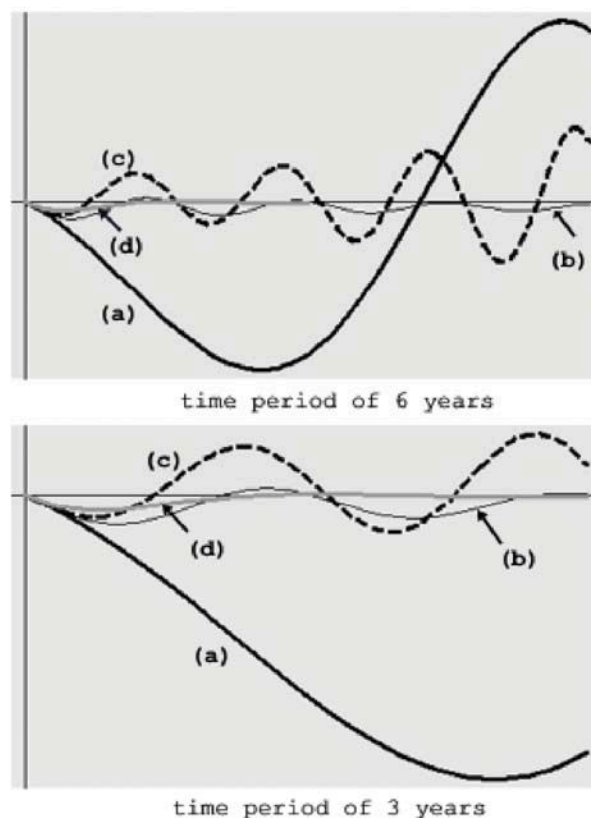

Fig. 10. Stabilization policies over a 3-6 years period : (a)no stabilization policy, (b)P-stabilization policy,(c)PI-stabilization policy, (d)PID-stabilization policy

4) *Block-diagram of the Phillips' model:* The block-diagram of the whole input-output system (without PID tuning) is shown in Fig.11 with simulation results. The Fig.12 represents block-diagram of the linear multiplier-accelerator subsystem. The multiplier-accelerator subsystem shows two distinct feedbacks : the multiplier and the accelerator feedbacks.

5) *System analysis:* Let denote the Laplace transform of $X(t)$ by

$$\bar{X}(s) \equiv \mathcal{L}[X(t)] = \int_0^{\infty} e^{-st} X(t) dt.$$

Omitting the disturbance $u(t)$, the model (1) to (4) is

$$\bar{Z}(s) = \bar{C}(s) + \bar{I}(s) + \bar{G}(s), \quad (6)$$

$$\bar{C}(s) = c\bar{Y}(s), \quad (7)$$

$$s\bar{I}(s) = -\beta\bar{I}(s) + \beta v s \bar{Y}(s), \quad (8)$$

$$s\bar{Y}(s) = -\alpha\bar{Y}(s) + \alpha\bar{Z}(s). \quad (9)$$

The transfer function (TF) of the system is

$$H(s) \equiv \frac{\bar{Y}(s)}{\bar{G}(s)} = \frac{\alpha s + \alpha}{s^2 + \left(\alpha(1 - c) + \beta - \alpha\beta v \right) s + \alpha\beta(1 - c)}$$

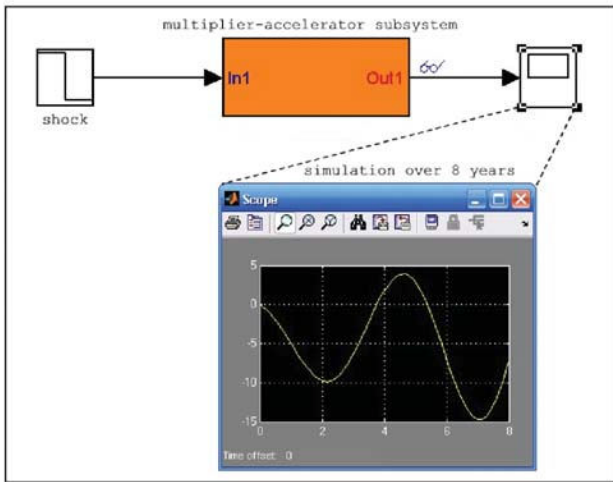

Fig. 11. Block diagram of the system and simulation results

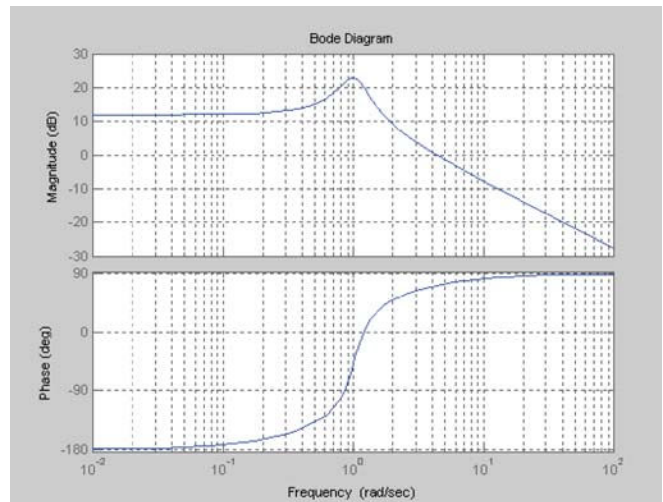

Fig. 13. Bode diagrams of the transfer function

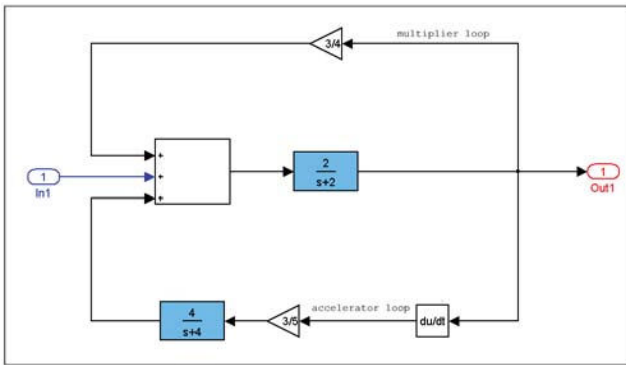

Fig. 12. Block diagram of the linear multiplier-accelerator subsystem

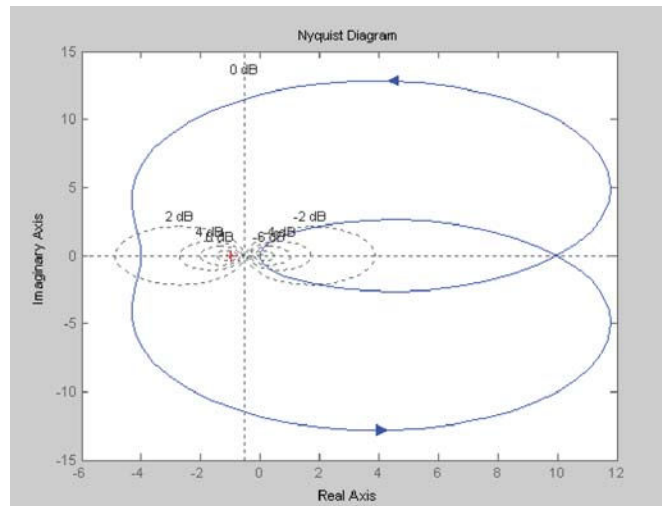

Fig. 14. Nyquist diagram of the transfer function

Taking a unit investment time-lag with $\beta = 1$ together with $\alpha = 4$, $c = \frac{3}{4}$ and $v = \frac{3}{5}$, we have

$$H(s) = 20 \frac{s + 1}{5s^2 - 2s + 5}$$

The constant of the TF is then 4, the zero is at $s = -1$ and poles are at the complex conjugates $s = .2 \pm j$. The Bode magnitude and phase plots are shown in Fig.13. The magnitude expressed in decibels ($20 \log_{10}$) is plotted with a log-frequency axis. The diagram shows a low frequency asymptote, a resonant peak and a decreasing high frequency asymptote. The cross-over frequency is 4 (rad/sec). To know how much a frequency will be phase-shifted, the phase (in degrees) is plotted with the a log-frequency axis. The phase cross over is near 1 (rad/sec). The TF of system is also

$$H(j\omega) = \frac{20j\omega + 20}{5\omega^2 - 2j\omega + 5}$$

When ω varies, the TF of the system is represented in Fig. 14 by the Nyquist diagram on the complex plane.

6) *PID control*: The block-diagram of the closed-loop system with PID tuning is shown in Fig.15. The PID controller

invokes three coefficients. The proportional gain $K_p e(t)$ determines the reaction to the current error. The integral gain $K_i = \int_0^t e(\tau) d\tau$ bases the reaction on sum of past errors. The derivative gain $K_d \frac{d}{dt} e(t)$ determines the reaction to the rate of change of error. The PID controller is a weighted sum of the three actions. A larger K_p will induce a faster response and the process will oscillate and be unstable for an excessive gain. A larger K_i eliminates steady states errors. A larger K_d decreases overshoot[9].¹⁴ A PID controller is also described by the following TF in the continuous s-domain [13]

$$H_C(s) = K_p + \frac{K_i}{s} + sK_d$$

The block-diagram of the PID controller is shown in Fig.16.

¹⁴The Ziegler-Nichols method is a formal PID tuning method : the *I* and *D* gains are first set to zero. The *P* gain is then increased until to a critical gain K_c at which the output of the loop starts to oscillate. Let denote by T_c the oscillation period, the gains are set to $.5K_c$ for a P-control, to $.45K_c + 1.2 \frac{K_p}{T_c}$ for a PI-control, to $.6K_c + 2 \frac{K_p}{T_c} + \frac{K_p T_c}{8}$ for a PID-control.

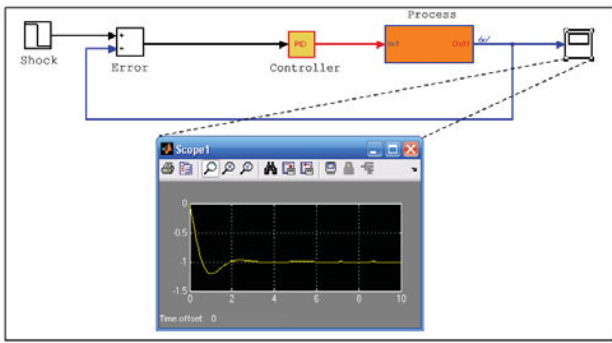

Fig. 15. Block diagram of the closed-loop system

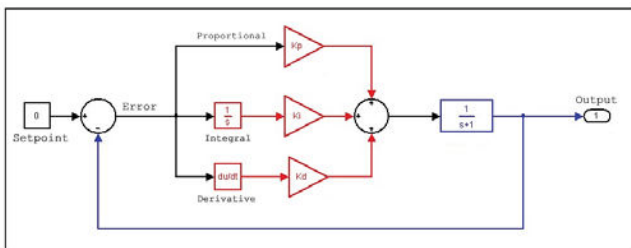

Fig. 16. Block diagram of the PID Controller

7) *Fuzzy control*: The closed-loop block-diagram of the Phillips' model is represented in Fig.17 with simulation results. It consists of the FLC block and of the TF of the model. The properties of the FLC controller have been described in Fig.1(design of the controller), Fig.3(membership functions), Fig.4(fuzzy rule base), Fig.5 (fuzzy surface) and Fig.7(output fuzzy set). The figures Fig.18 show the efficiency of such a stabilization policy. The range of the fluctuations has been notably reduced with a fuzzy control. Up to six years, the initial range $[-12, 12]$ goes to $[-3, 3]$.

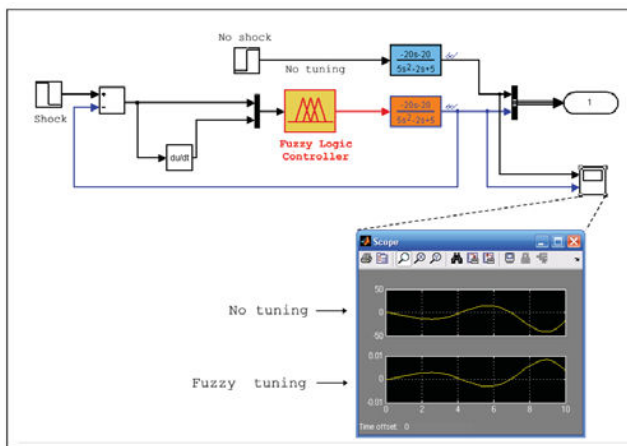

Fig. 17. Block diagram of the Phillips model with Fuzzy Control

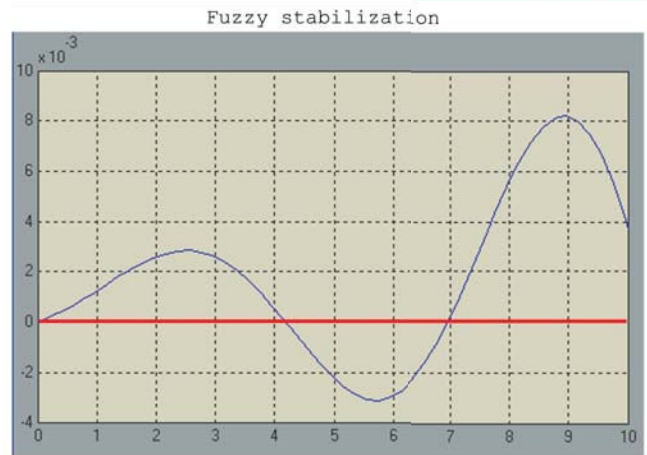

Fig. 18. Fuzzy Stabilization of the Phillips' model

B. The nonlinear Goodwin model

1) *Presentation*: The extended model of Goodwin [2][15][17] is a multiplier-accelerator with a nonlinear accelerator. The system is

$$Z(t) = C(t) + I(t), \quad (10)$$

$$C(t) = cY(t) - u(t), \quad (11)$$

$$\frac{dI(t)}{dt} = -\beta(I(t) - B(t)), \quad (12)$$

$$B(t) = \Phi\left(v \frac{d}{dt} Y(t)\right), \quad (13)$$

$$\frac{dY(t)}{dt} = -\alpha(Y(t) - Z(t)). \quad (14)$$

The aggregate demand Z in (10) is the sum of consumption C and total investment I ¹⁵. The consumption function in (11) is not lagged on income Y . The investment (expenditures and deliveries) is determined in two stages : at the first stage, investment I in (12) depends on the amount of the investment decision B with an exponential lag; at the second stage the decision to invest B in (13) depends non linearly by

¹⁵The autonomous constant component is ignored since Y is measured from a stationary level

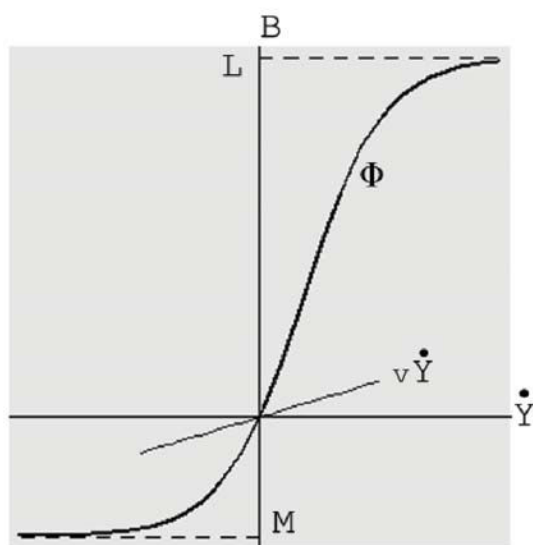

Fig. 19. Nonlinear accelerator in the Goodwin's model

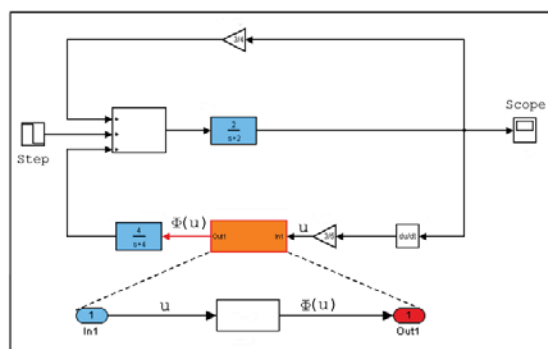

Fig. 20. Block-diagrams of the Nonlinear accelerator

Φ on the rate of change of the production Y . The equation (14) describes a continuous gradual production adjustment to demand. The rate of change of supply Y is proportional to the difference between demand and production at that time (with speed of response α). The nonlinear accelerator Φ is defined by

$$\Phi(\dot{Y}) = M \left(\frac{L + M}{Le^{-v\dot{Y}} + M} - 1 \right),$$

where M is the scrapping rate of capital equipment and L the net capacity of the capital-goods trades. It is also subject to the restrictions

$$B = 0 \text{ if } \dot{Y} = 0, \quad B \rightarrow L \text{ as } \dot{Y} \rightarrow +\infty, \\ B \rightarrow -M \text{ as } \dot{Y} \rightarrow -\infty. \quad (15)$$

The graph of this function is shown in Fig.19.

2) *Block-diagrams*: The block-diagrams of the nonlinear multiplier-accelerator are described in Fig.20.

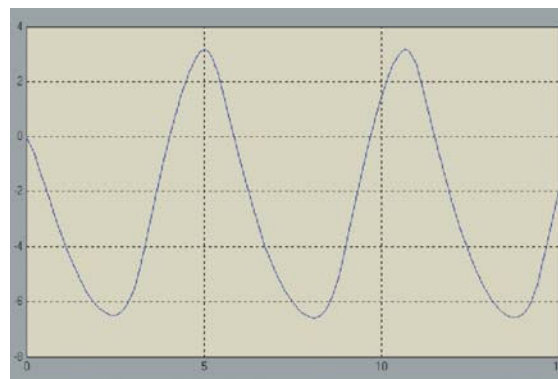

Fig. 21. Simulation of Nonlinear accelerator

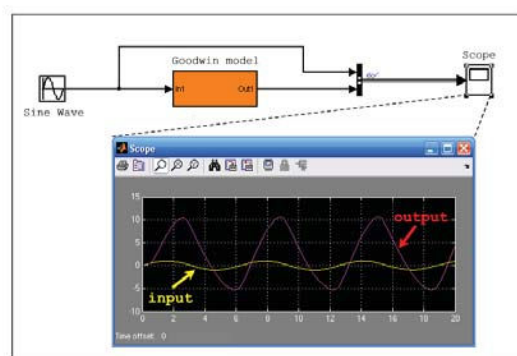

Fig. 22. Simulation of sinusoidal input

3) *Dynamics of the Goodwin's model*: The simulation results show strong and regular oscillations in Fig.21. The Fig.22 shows how a sinusoidal input is transformed by the nonlinearities. The amplitude is strongly amplified, and the phase is shifted.

4) *PID control of the Goodwin Model*: The Fig.23 shows the block-diagram of the closed-loop system. It consists of a PID controller and of the subsystem of Fig.20. The Fig.24 shows the simulation results which objective is to maintain the system at a desired level equal to 2.5. This objective is reached with oscillations within a time-period of three years. Thereafter, the system is completely stabilized.

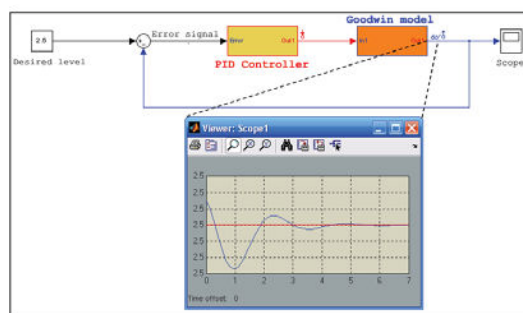

Fig. 23. Block-diagram of the PID Controlled Goodwin model

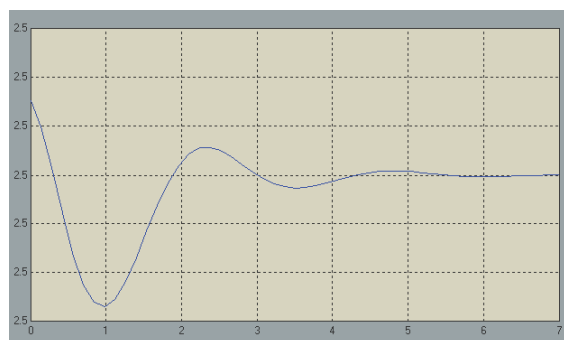

Fig. 24. Simulation of the PID Controlled Goodwin model

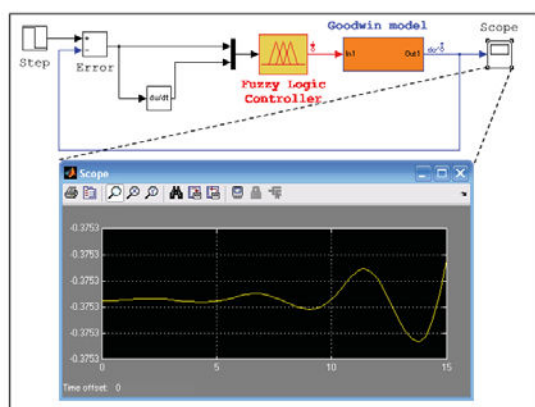

Fig. 25. Block-diagram of the fuzzy Controlled Goodwin model

5) *Fuzzy control of the Goodwin Model:* The Fig.25 shows the block-diagram of the controlled system. It consists of a fuzzy controller and of the subsystem of the Goodwin model (See Fig.20). The FLC controller is unchanged. The simulation results in Fig.26 show an efficient and fast stabilization. The system is stable within five time-periods, and then fluctuates in an explosive way but restricted to an extremely close range.

IV. CONCLUSION

Compared to a PID control, the simulation results of a linear and nonlinear multiplier-accelerator model show a more

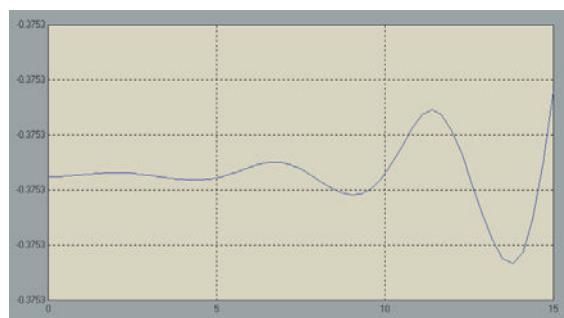

Fig. 26. Simulation of the fuzzy Controlled Goodwin model

efficient stabilization of the economy within an acceptable time-period of few years in a fuzzy environment.

REFERENCES

- [1] A. Afshari and C. Georgescu, A fuzzy model-based optimal control strategy, *Proceedings of the 1994 Symposium on Applied Computing*:120–125, 1994.
- [2] R.G.D Allen , The engineer's approach to economic models, *Economica*, **22**(86):158–168, 1955.
- [3] R.G.D Allen , "Macro-Economic Theory ; A Mathematical Treatment", London:MacMillan, 1967.
- [4] K. J.Åström, "stochastic Control Theory", Mineola, N.Y.:Dover Publications, Inc.,1970.
- [5] J. F.Baldwin and N.-C. F Guild, Modelling controllers using fuzzy relations, *Kybernetes*, **9**:223–229, 1980.
- [6] D.P. Bertsekas, "Dynamic Programming : Deterministic and Stochastic Models", Englewood Cliffs, NJ:Prentice-Hall Inc, 1987.
- [7] M. Braae and D.-A. Rutherford, Fuzzy relations in a control setting, *Kybernetes*, **7**:185–188, 1978.
- [8] M. Braae and D.-A. Rutherford, Theoretical and Linguistic Aspects of the fuzzy logic controller, *Automatica*, **15**:553–577, 1979.
- [9] M. Braae and D.-A. Rutherford, Selection of parameters for a fuzzy logic controller, *Fuzzy Sets and Systems*, **2**:185–199, 1979.
- [10] A. C. Chiang, "Dynamic Optimization", New York:McGraw-Hill,Inc, 1972.
- [11] S. Chopra, R. Mitra and V. Kumar, Fuzzy controller : choosing an appropriate and smallest rule set, *International Journal of Computational Cognition*, **3**(4):73–79, 2005.
- [12] B.-M. Chung and J.-H. Oh, Control of dynamic systems using fuzzy learning algorithm, *Fuzzy Sets and Systems*, **59**:1-14, 1993.
- [13] P. Cominos and N.Nunro, PID Controllers : recent tuning methods and design to specification, *IEE Proc.-Control Theory*, **149**(1):46–53, 2002.
- [14] P. Flaschel, R. Franke and W. Semmler, "Dynamic Macroeconomics : Instability, Fluctuations and Growth in Monetary Economics",Cambridge, Mass.:The MIT Press, 1997.
- [15] G. Gabisch and H. W. Lorenz, "Business Cycle Theory : A survey of methods and concepts", New York:Springer-Verlag, 1989.
- [16] G. Gandolfo , "Economic Dynamics : methods and models", Amsterdam:North-Holland, 1980.
- [17] R. M. Goodwin, The nonlinear accelerator and the persistence of business cycles,*Econometrica*, **19**(1):1–17,1951.
- [18] M. M. Gupta,G. M. Trojan and Kiszka J. B., Controllability of fuzzy control systems,*IEEE Transactions on Systems, Man, and Cybernetics*, **SMC-16**(4):576–589,1986.
- [19] M. I. Kamien and N. L. Schwartz, "Dynamic Optimization : The Calculus of Variations and Optimal Control in Economics and Management", 2nd ed., New York:North-Holland, 1991.
- [20] T. Kitamoto, M. Saeki, K. Ando, CAD Package for Control System on Mathematica, *IEEE*, **448**–451,1992.
- [21] G.J. Klir and B. Yuan, "Fuzzy Sets and Fuzzy Logic: Theory and Applications", Upper Saddle River, N.J.:Prentice Hall, 1995.
- [22] B. Kosko,"Neural networks and fuzzy systems : a dynamical systems approach to machine intelligence", Englewood Cliffs, NJ:Prentice-Hall Inc, 1992.
- [23] C. C. Lee, Fuzzy logic in control systems: fuzzy logic controller-Parts I and II,*IEEE Transactions on Systems, Man, and Cybernetics*, **20**(2):404–435,1990.
- [24] K. M. Passino and S. Yurkovich, "Fuzzy Control", Menlo Park, Ca:Addison-Wesley, 1998.
- [25] A. W. Phillips, Stabilisation policy in a closed economy, *Economic Journal*, **64**(266):290–323, 1954.
- [26] A. W. Phillips,Stabilisation policy and the time-forms of lagged responses, *Economic Journal*, **67**(266):265–277, 1957.
- [27] J. D. Pitchford and S. J. Turnovsky,"Applications of Control Theory to Economic Analysis", Amsterdam:North-Holland, 1977.
- [28] M. J. Rao,"Filtering and Control of Macroeconomic Systems", Amsterdam:North-Holland, 1987.
- [29] R. Shone,"Economic Dynamics : Phase Diagrams and their Economic Application", 2nd ed. Cambridge UK:Cambridge University Press, 2002.
- [30] M. S. Stachowicz and L. Beall, *MATHEMATICA Fuzzy Logic*, Wolfram Research, 2003. Available: <http://www.wolfram.com>.
- [31] T. Terano, K. Asai and M. Sugeno, *Fuzzy Systems and Its Applications*, New York : Academic Press, Inc, 1987.

- [32] The MathWorks inc., User's Guide : "MATLAB 7", "Simulink 7", "Simulink Control Design", "Control System Design", "Fuzzy Logic Toolbox 2".
- [33] S. J. Turnovsky, *Macroeconomic analysis and Stabilization Policy*, Cambridge : Cambridge University Press, 1977.
- [34] A. Tustin, *The Mechanism of Economic Systems*, London:William Heine-
mann, LTD, 1953.
- [35] Wolfram Research, "Control System Professional", 2nd edition, 2005.
- [36] H. Ying , *Fuzzy Control and Modeling : Analytical Foundations and Applications*, New York:IEEE (The Institute of Electrical and Electronics Engineers) Press, 2000.
- [37] H. -J. Zimmermann , *Fuzzy Set Theory and its Application*, Cam-
bridge:Cambridge University Press, 1977.



André A. Keller is Professor in Mathematical Economics of the Université de Haute Alsace (UHA) in Mulhouse (France). He received his PhD in Economics (Operation Research: graph theory) from the Université de Paris. He is currently a researcher of the GRAICO (Research Group for Learning, Innovation and Knowledge in Organizations) in the UHA. He teaches applied mathematics, microeconomics, theory of games and dynamic macroeconomic analysis.

Since 1980, he has been Associate Professor at the Université de Paris and researcher in a research unit of the Centre National de la Recherche Scientifique. His experience centers are on building and analyzing large size macro-econometric models, as well as forecasting.

Since 1985, his research interest has concentrated on high frequency time-series modeling with application to the foreign exchange market : spectral properties of usual filters, automatic selection of ARIMA models, efficiency tests.

Since 1990, Prof. Keller's research is centered on graph theory, differential games and dynamics in economic modeling.