

A Novel Approach to EMABS and Comparison with ABS

Mehrdad N. Khajavi, and Abbas Hosseini, N.Bani Mostafa

Abstract—In this paper two different Antilock braking system (ABS) are simulated and compared. One is the ordinary hydraulic ABS system which we call it ABS and the other is Electromagnetic Antilock braking system which is called (EMABS) the basis of performance of an EMABS is based upon Electromagnetic force. In this system there is no need to use servo hydraulic booster which are used in ABS system. In EMABS to generate the desired force we have use a magnetic relay which works with an input voltage through an air gap (g). The generated force will be amplified by the relay arm, and is applied to the brake shoes and thus the braking torque is generated. The braking torque is proportional to the applied electrical voltage E. to adjust the braking torque it is only necessary to regulate the electrical voltage E which is very faster and has a much smaller time constant T than the ABS system. The simulations of these two different ABS systems are done with MATLAB/SIMULINK software and the superiority of the EMABS has been shown.

Keywords—ABS, EMABS, ECU

I. INTRODUCTION

SINCE the development of first motor driven in 1769 and the occurrence of first driving accident in 1770, the engineers were determined to reduce driving accidents and improve safety of the vehicles [1]. It is obvious to reduce accidents; design of an efficient braking system is a must. Vehicle experts have developed this field through new and invention, in 1930 the first mechanical ABS system have been designed and produced in aerospace industry [1]. Because of it is good performance, in 1980 the first ABS system was designed and implemented on road vehicles. Fig. 1 shows the evolution of ABS systems in time [2].

Mehrdad Nouri Khajavi is with the Mechanical Engineering Department, Shahid Rajaei University, Tehran, Iran

Abbas Hosseini is with Mechanical Engineering Department, Shahid Rajaei University, Tehran, Iran

N. Bani Mostafa is with Mechanical Engineering Department, Shahid Rajaei University, Tehran, Iran

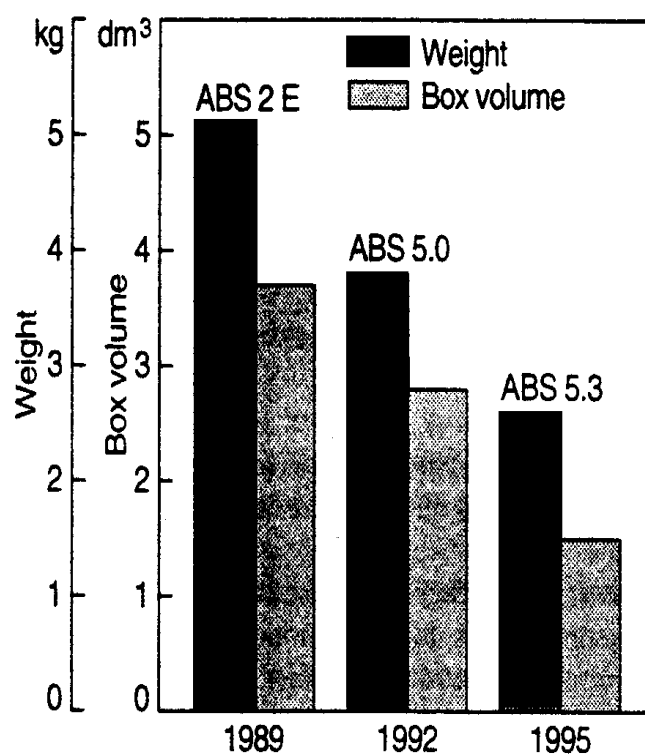

Fig. 1 Evolution of ABS system in time

The goal of all the improvements in these systems was to reduce volume and weight and fast and optimum operation of the system. In this paper we have combined two electromagnetic and hydraulic systems and introduce a new system which has a better performance than the existing systems. As we know all one of the forces which has a lot of applications in industry is Electromagnetic force. In conventional brake systems the basis for generating braking force are hydraulics. In conventional braking systems, the driver forces the brake pedal based on the different conditions. Compression of the pedal generates actuating force in the braking system. This system consists of servo booster. The driver's foot force is amplified by vacuum or hydraulic pressure and hydraulic circuits transmits this amplified force to the wheel cylinder and braking process results [3]. Now if the hydraulic pressure is high enough to lock the wheel the ABS system unlocks the wheel by reducing the back pressure

of the wheel cylinder. (This is done by hydraulic valves) [3], [4], [5]. Fig. 2 shows the overall configuration of the hydraulic brakes.

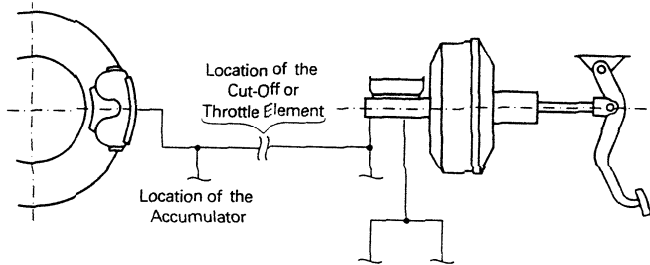

Fig. 2 Overall configuration of the hydraulic brakes

In *EMABS* the braking torque is provide by a magnetic relay. By applying electrical voltage E to the relay in air gap (g) the electromagnetic force is produce which is applied to the brake shoes, thus providing the braking torque. If the generated force was so much that causes the wheel to lock, the *EMABS* sends the appropriated command and the voltage decreases and subsequently the braking torque-decreases and the wheel unlocks. By simulating both *ABS* and *EMABS* in this paper, it is shown that the transfer function of *EMABS* is different than that of *ABS* and also *EMABS* out performs *ABS*.

II. ANTI-LOCK BRAKING SYSTEM (ABS)

A. Fundamentals of ABS system

Three different forces act on tire as shown in Fig. 3. These are F_n which is due to vehicle weight, F_s which is the lateral force and will be generated due to turning of the vehicle and is a friction force, and F_u which will be generated when the vehicle accelerates or decelerates. And it is also a friction force [3].

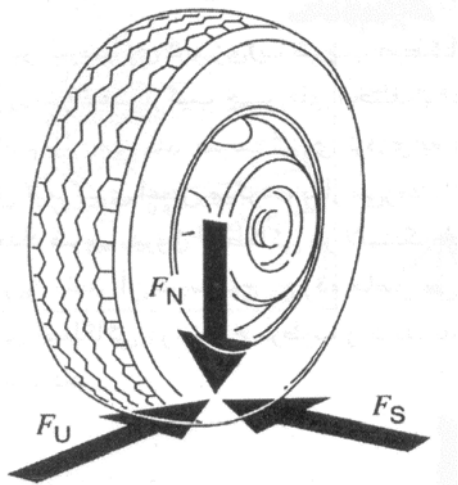

Fig. 3 Side, Longitudinal and Normal forces on tire

ABS and Traction control system (*TCS*) use these frictional forces for effective and optimum use of friction with road surface [3].The friction force is proportional to normal force and is equal to [1]:

$$F_R = \mu F_N \quad (1)$$

Velocity is one of the most important faster affecting friction coefficients. When one of the wheels locks, the capability of transferring lateral and longitudinal forces decrease and the vehicle can not response to steering input [3].

The slip factor is defined as [1]:

$$\lambda = \frac{V - r\omega}{V} \quad (2)$$

In the above formula V is vehicle speed, r is the wheel radius and ω is the angular velocity of the wheel. Fig. 4 shows the variation of lateral and longitudinal friction coefficient in terms of slip factor [1], [3], [6].

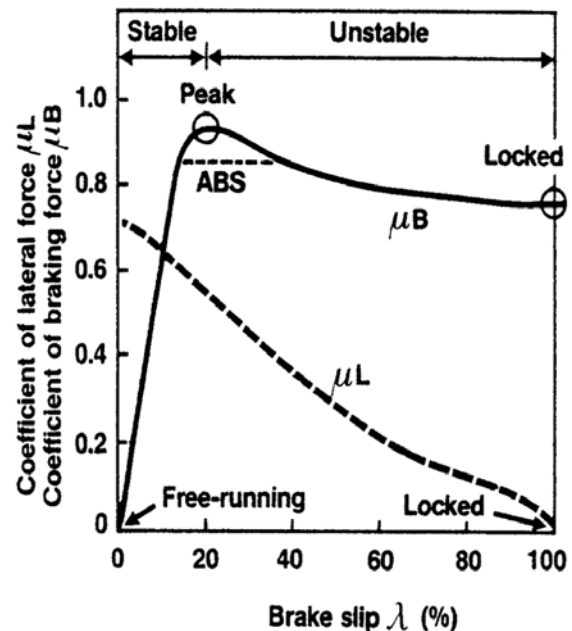

Fig. 4 Variation of lateral and longitudinal friction Coefficient versus of slip factor

ABS system by changing the braking force control the slip and do not permit the slip factor to enter the unstable region of the control system acts the more effective the braking performance will be [1], [3].

B. Structure of ABS

In *ABS*, with the application of driver's foot pressure on the brake pedal, Hydraulic pressure is amplified and applied to the wheel cylinder. This action happens when the inlet valve is in the first position \updownarrow . If the applied pressure is great enough to cause locking of the wheel the wheel rotation sensor detects locking and send the corresponding signal to *ECU*. After receiving this signal, *ECU* changes the condition of the inlet valve to the second position \square and the condition of

the outlet valve to the first position \square . This means the wheel cylinder is separated from the main and return circuit and the braking pressure is maintained at a constant pressure.

After this process, the inlet valve is remained in the second position \uparrow and the outlet valve will switch to the second position \uparrow and the wheel cylinder is connected to the return circuit and the hydraulic pressure decreases. With decreasing pressure, the braking torque reduces and thus the wheel

unlocks. At this time the wheel rotational sensor an appropriate signal to the *ECU*, and *ECU* commands the return pump to pressurize the hydraulic circuit and the inlet valve will switch to the first position and hydraulic pressure increases. This pressure increase may lock the wheel again and the above process will be repeated [2], [3].

The structure and layout different parts of ABS system are shown in Fig. 5.

ANTILOCK BRAKE SYSTEM COMPONENTS

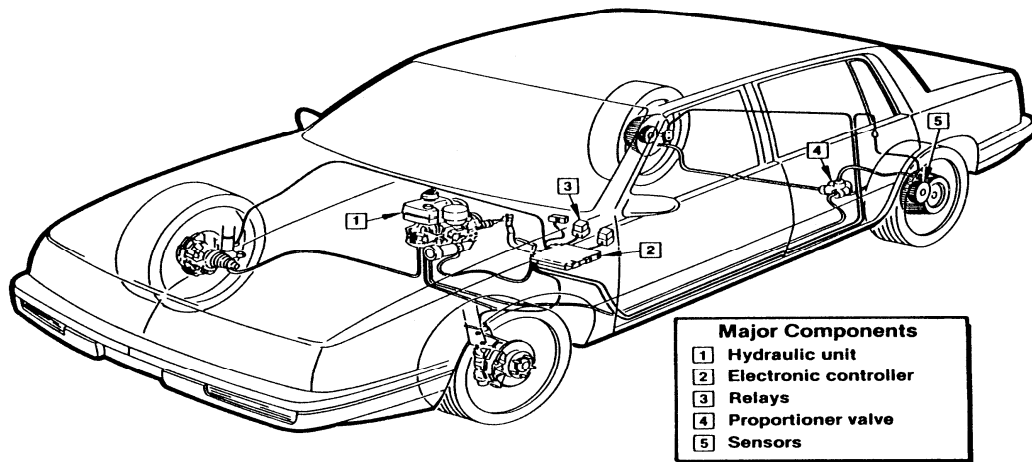

Fig. 5 Structure and layout of different parts of ABS

Thus in *ABS* for unlocking the wheel we have to change the amount of oil volume in the system. The configuration and layout of the different parts of *ABS* is shown in Fig. 6.

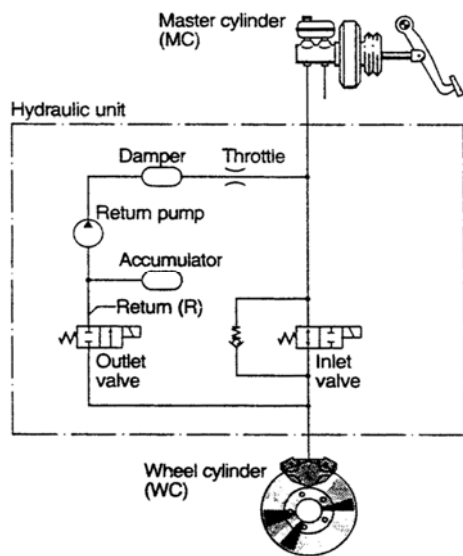

Fig. 6 Configuration and layout different parts of ABS system

III. EMABS

A. Fundamentals of EMABS

In *EMABS* for generating the required force, an electrical relay will be used with application of electrical current (I) to the inductance, a force is generated in the air gap (g), which is equal to [7]

$$F = \frac{\mu_0}{2} A \left(\frac{NI}{g} \right)^2 \quad (3)$$

Thus by increasing or decreasing the electrical current in the inductance, the electromagnetic force (F) will be increased or decreased and this force can be controlled. With the application of electric current to the inductance, the L position of the pivoted arm is pushed down and the L' portion is forced up and results in a force F' which will be used as the braking force [8]

$$F' = \frac{L}{L'} F \quad (4)$$

Structure of electrical relay of *EMABS* is shown in Fig. 7.

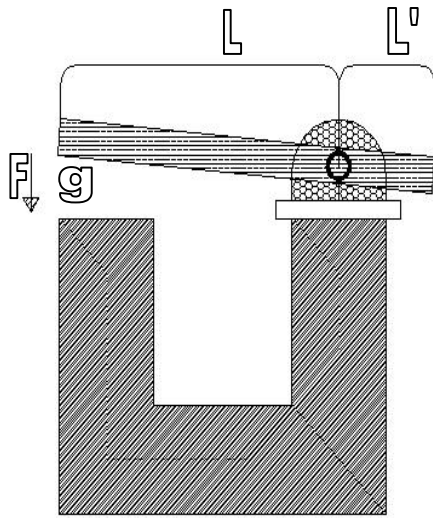

Fig. 7 Structure of electrical relay of EMABS

B. structure of EMABS

In proposed EMABS there is no need to use hydraulic units and the change of the oil volume for regulating brake force. This action is done only by changing the input electrical voltage and by controlling this voltage we can regulate the braking force rapidly. Configuration and layout of different parts of EMABS system is shown in Fig. 8. Considering the relation [7]

$$V = I(LD + R) \tag{5}$$

If the braking force is enough to lock the wheel, the sensor sends the corresponding signal to ECU. Therefore ECU decreases the voltage and the electromagnetic force will be reduced therefore the braking force will be reduced and the wheel unlocks, this process can be repeated if required. In this system reduction of time constant of the response is very important. The governing equation of dynamics of EMABS is as follows [7]:

$$I = (I_0 - I_\infty)e^{-\frac{t}{T}} + I_\infty$$

when

$$I_\infty = \frac{V}{R}, I_0 = 0$$

we have

$$I = \frac{V}{R}(1 - e^{-\frac{t}{T}})$$

$$I = \left[\frac{1}{R}(1 - e^{-\frac{t}{T}}) \right] V$$

(6)

To compare the performance of ABS and EMABS the equations of each of these systems are simulated by MATLAB/SIMULINK software. Fig. 15 shows the SIMULINK block diagram of EMABS system [9].

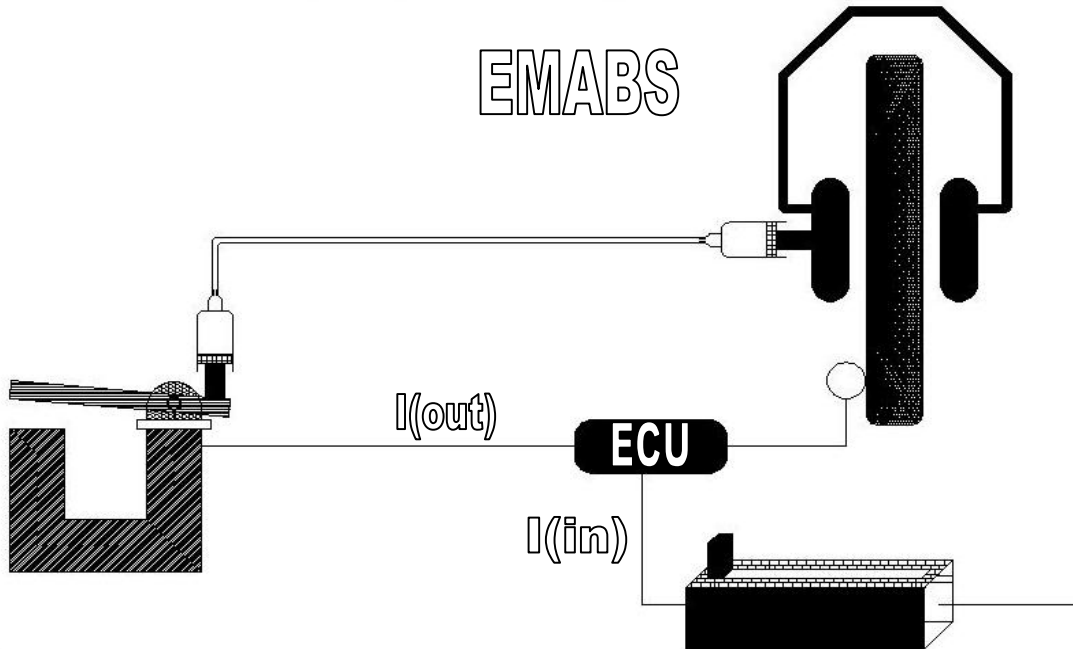

Fig.8 configuration and layout of different parts of EMABS system

IV. CONCLUSION

By comparing the results of the simulations the following conclusions are obtained.

- 1- The stopping distance (SD) is reduced in *EMABS*, Fig. 9 shows this conclusion.
- 2- The vehicle speed becomes zero in *EMABS* faster than *ABS*, Fig. 10 shows this conclusion.

- 3- The numbers of locking and unlocking is more in a specified period of time in *EMABS*, Fig. 11 shows this conclusion.
- 4- In *EMABS* the braking coefficient of friction will stay at a longer time at its maximum value μ_{max} , Fig. 12 shows this conclusion.
- 5- The slip factor of *EMABS* is controlled better than *ABS*, Fig. 13 shows this conclusion.

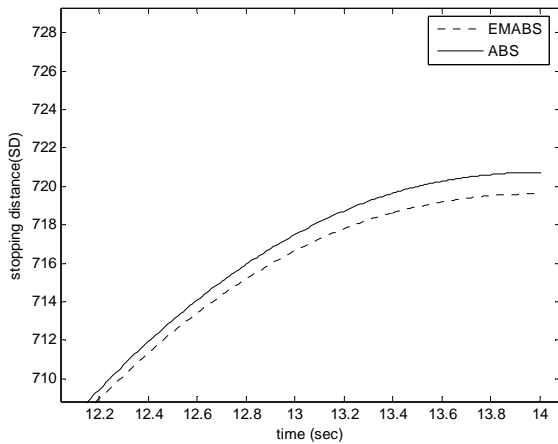

Fig. 9 comparing stopping distance (SD) with *ABS* and *EMABS*.

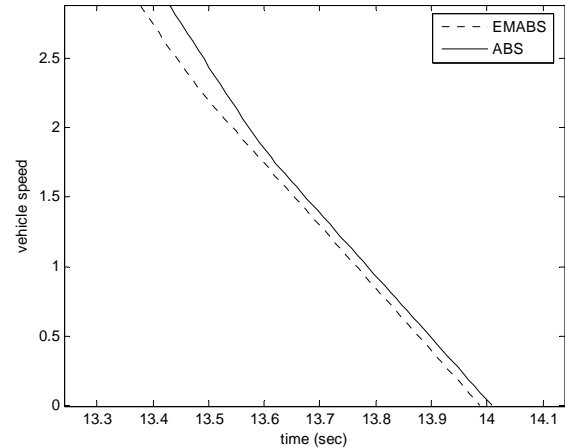

Fig. 10 comparing vehicle speed with *ABS* and *EMABS*.

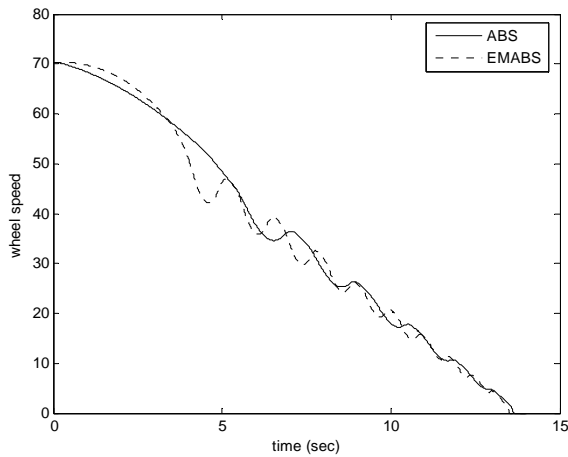

Fig. 11 comparing the numbers of locking and unlocking with *ABS* and *EMABS*.

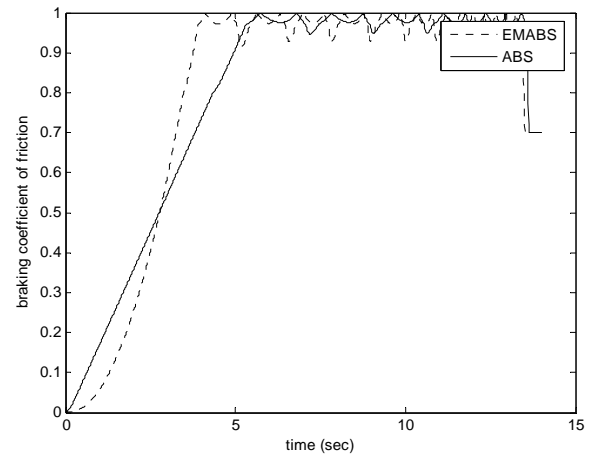

Fig. 12 comparing the braking coefficient of friction with *ABS* and *EMABS*

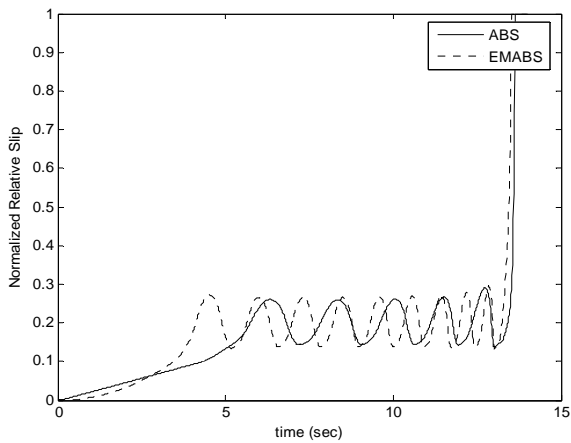

Fig. 13 comparing the normalized relative slip with ABS And EMABS

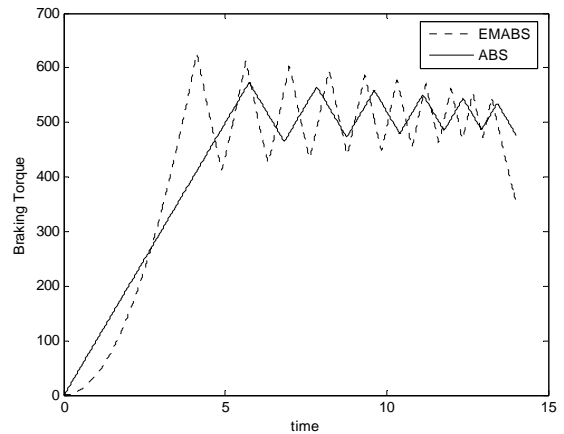

Fig. 14 comparing the braking torque with ABS And EMABS

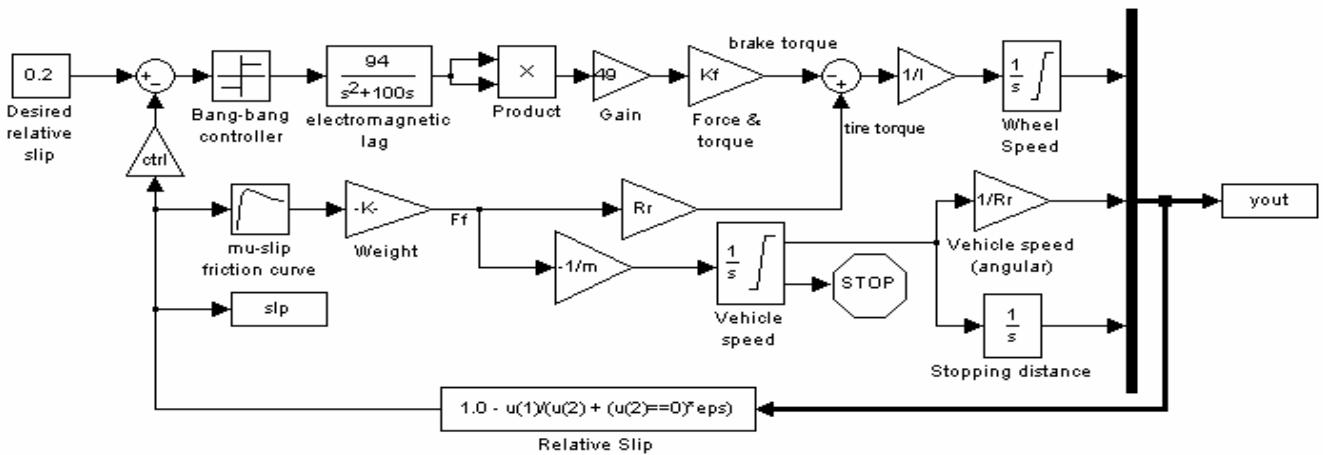

Fig. 15 EMABS SIMULINK block diagram

REFERENCES

- [1] T.D.Gilleospie " Fundamentals of vehicle dynamics "
- [2] M.Maier, K.Muller "The new and compact ABS unit for passenger cars" SAE paper NO.950757, 1996
- [3] A.Czinczel, K.Kuhner, A.Stegmaier "Brake systems"
- [4] P.Hattwig "Synthesis of ABS hydraulic system SAE paper NO. 930509, 1996
- [5] W.Maisch,W.Dieter,J.R.Mergenthaler " ABS_5 and ASR_5 :The new ABS/ASR family to optimize directional stability and traction" SAE paper NO.930505, 1996
- [6] P.Oppenheimer "Comparing stopping capability of cars with and without anti-lock braking system" SAE paper NO.880324, 1996
- [7] D.K.Cheng "Field and wave electromagnetic"
- [8] J.L.Meriam, L.G.Kraige "Engineering mechanics"
- [9] SIMULINK User's Guide. The MathWorks Inc., 2004.