

# New Robust Approach of Direct Field Oriented Control of Induction Motor

T. Benmiloud, A. Omari

**Abstract**—This paper presents a new technique of compensation of the effect of variation parameters in the direct field oriented control of induction motor. The proposed method uses an adaptive tuning of the value of synchronous speed to obtain the robustness for the field oriented control. We show that this adaptive tuning allows having robustness for direct field oriented control to changes in rotor resistance, load torque and rotational speed. The effectiveness of the proposed control scheme is verified by numerical simulations. The numerical validation results of the proposed scheme have presented good performances compared to the usual direct-field oriented control.

**Keywords**—Induction motor, direct field-oriented control, compensation of variation parameters, fuzzy logic controller.

## I. INTRODUCTION

INDUCTION machine drives controlled by the field-orientation technique have been employed in high performance industrial applications. The field-orientation control [11] scheme enables the control of the induction motor in the same way as a separately excited direct current (DC) motor. The two major methods of high performance control [3] of induction motor drives are the direct field oriented control (DFOC) and the indirect field oriented control (IFOC). The IFOC control is generally called slip frequency control, while in a DFOC control system, the flux angle is employed directly in decoupling the torque and flux components. The main draw-back of induction motor field oriented systems is that the performance of these systems will be degraded due to the motor parameters uncertainties, as well as due to the external load torque disturbance. Hence, many researchers have attempted to propose various methods to solve this problem.

In this work, for the purpose to improve the robustness and performances of the direct field oriented control of induction motor, we use an adaptive mechanism for the orientation of the rotor flux. The adaptive mechanism consists to use the error of control of mechanical speed to make the adaptation of the speed of synchronism, so as to compensate the parametric variation effects on the orientation of the rotor

T. Benmiloud is with the Department of Electrotechnics, Faculty of Electrical Engineering, University of Sciences and Technology USTOran-ALGERIA BP 1505 El-Mnaouar/ Oran, Algeria (email: tarek\_bm2004@yahoo.fr)

A. Omari is with the Department of Automatic, Faculty of Electrical Engineering, University of Sciences and Technology USTOran-ALGERIA (email: omari@univ-usto.dz)

flux. This robust direct field oriented control (RDFOC) is well suited to have fast and accurate flux regulation, with increased robustness against parameter variations.

This paper is organised as follows. In Section II, the classic DFOC control of induction machine is presented. Section III presents the proposed RDFOC control for compensate the effect of variation parameters. In Section IV, the effectiveness of this robust control is discussed via simulation results. Section V presents the final remarks.

## II. MOTOR MODEL AND FIELD-ORIENTED CONTROL

### A. Review Stage

Modern control techniques often require a state-space model [8]. The state-space representation of the asynchronous motor depends on the choice of the reference frame  $(\alpha, \beta)$  or  $(d, q)$  and on the state variables selected for the electric equations. We write the equations in the frame  $(d, q)$  because it is the most general and most complex solution [1]. The IM mathematical model, in space vector notation, established in  $d$ - $q$  coordinate system rotating at synchronous speed  $\omega_s$  is given by the following equations. The IM mathematical model, in space vector notation, established in  $d$ - $q$  coordinate system rotating at synchronous speed  $\omega_s$  is given by the following equations. Electric equations [4] [5] are:

$$\begin{aligned} u_{sd} &= R_s \cdot i_{sd} + \frac{d\phi_{sd}}{dt} - \omega_s \cdot \phi_{sq} \\ u_{sq} &= R_s \cdot i_{sq} + \frac{d\phi_{sq}}{dt} + \omega_s \cdot \phi_{sd} \\ 0 &= R_r \cdot i_{rd} + \frac{d\phi_{rd}}{dt} - \omega_r \cdot \phi_{rq} \\ 0 &= R_r \cdot i_{rq} + \frac{d\phi_{rq}}{dt} + \omega_r \cdot \phi_{rd} \end{aligned} \quad (1)$$

Magnetic equations:

$$\begin{aligned} \phi_{sd} &= L_s \cdot i_{sd} + M i_{rd} \\ \phi_{sq} &= L_s \cdot i_{sq} + M i_{rq} \\ \phi_{rd} &= L_r \cdot i_{rd} + M i_{sd} \\ \phi_{rq} &= L_r \cdot i_{rq} + M i_{sq} \end{aligned} \quad (2)$$

Electromagnetic torque equation:

$$T_e = p \cdot \frac{M}{L_r} (\phi_{rd} \cdot i_{sq} - \phi_{rq} \cdot i_{sd}) \quad (3)$$

Mechanical equation:

$$\dot{\omega}_r = \frac{p^2 M}{J L_r} (\phi_{rd} \cdot i_{sq} - \phi_{rq} \cdot i_{sd}) - \frac{p}{J} T_L - \frac{f}{J} \omega_r \quad (4)$$

Combining equations (1) and (4), we can write the motor model as [6] [9]

$$\begin{bmatrix} \dot{i}_{sd} \\ \dot{i}_{sq} \\ \dot{\phi}_{rd} \\ \dot{\phi}_{rq} \\ \dot{\omega}_r \end{bmatrix} = \begin{bmatrix} -\gamma i_{sd} + \omega_s i_{sq} + \frac{K}{T_r} \phi_{rd} + p \omega_r K \phi_{rq} + \frac{1}{\sigma L_s} u_{sd} \\ -\omega_s i_{sd} - \gamma i_{sq} - p \omega_r K \phi_{rd} + \frac{K}{T_r} \phi_{rq} + \frac{1}{\sigma L_s} u_{sq} \\ \frac{M}{T_r} i_{sd} - \frac{1}{T_r} \phi_{rd} + (\omega_s - p \omega_r) \phi_{rq} \\ \frac{M}{T_r} i_{sq} - (\omega_s - p \omega_r) \phi_{rd} - \frac{1}{T_r} \phi_{rq} \\ \frac{p^2 M}{J L_r} (\phi_{rd} i_{sq} - \phi_{rq} i_{sd}) - \frac{f}{J} \omega_r - \frac{p}{J} T_L \end{bmatrix} \quad (5)$$

Where  $\sigma = 1 - \frac{M^2}{L_s L_r}$ ,  $\gamma = \left( \frac{R_s}{L_s} + \frac{R_r(1-\sigma)}{\sigma L_r} \right)$  and  $K = \frac{(1-\sigma)}{\sigma M}$

As state variables, we have the two components of stator currents ( $i_{ds}, i_{qs}$ ) the two components of the rotor flux ( $\phi_{dr}, \phi_{qr}$ ) and the mechanical speed  $\omega_r$ .

### III. ROTOR FIELD ORIENTED CONTROL

There are many categories of vector control strategies. We are interested in this study to the so-called DFOC control. We have shown in equation (3) that the electromagnetic torque expression, in the dynamic regime, presents a coupling between stator current and rotor flux. The main objective of the vector control of induction motor is, as in direct current machines, to independently control the torque and the flux. This is done by using a d-q rotating reference frame synchronously with the rotor flux space vector. The d-axis is aligned with the rotor flux space vector. Under this condition, we have ;  $\phi_{dr} = \phi_r$  and  $\phi_{qr} = 0$ . In this case the torque equation becomes:

$$T_e = p \cdot \frac{M}{L_r} \phi_{rd} \cdot i_{sq} \quad (6)$$

We obtain the equation of the pulsation of slipping:

$$\omega_{sl} = \frac{L_m \cdot R_r}{L_r \cdot \phi_r} \cdot i_{sq} \quad (7)$$

The equation of the speed of synchronism will be thus:

$$\omega_s = \omega_r + \frac{L_m \cdot R_r}{L_r \cdot \phi_r} \cdot i_{sq} \quad (8)$$

It is right to adjust the flux while acting on the component  $i_{ds}$  of the stator current and to adjust the torque while acting on the  $i_{qs}$  component. We have two variables of action then as in

the case of a direct current machine. Combining equations (1) and (2) we obtain the following d and q-axis stator currents:

$$i_{sd} = \frac{(1+T_r s)}{M} \phi_r \quad (9)$$

$$i_{sq} = \frac{T}{M} \omega_{sl} \phi_r \quad (10)$$

Using equations (1)-(2), we obtain the voltage equations:

$$\begin{aligned} u_{sd} &= (R_s + \sigma L_s s) i_{sd} + \frac{M}{L_r} p \phi_r - \sigma L_s \omega_s i_{sq} \\ u_{sq} &= (R_s + \sigma L_s s) i_{sq} + \sigma L_s \omega_s i_{sd} + \frac{M}{L_r} \omega_s \phi_r \end{aligned} \quad (11)$$

The rotor flux amplitude is obtained by solving (9), and its spatial position is given by

$$\theta_s = \int \left( \omega_r + \frac{M i_{sq}}{T_r \phi_r} \right) dt \quad (12)$$

The mechanical speed is:  $\Omega_m = \frac{\omega_r}{p}$

These equations are functions of some structural electric parameters of the induction motor ( $R_s, R_r, L_s, L_r, L_m$ ), which are in reality approximate values. We will come back thereafter to the influence of the bad knowledge of most interest parameter ( $T_r=L_r/R_r$ ) on the control of the machine [7].

### IV. PRINCIPLE OF COMPENSATION

In the direct field oriented control, the slip speed of induction motor is function of the rotor resistance [1], [2]. So, the variation in the value of rotor resistance affects the value of slip speed, an error in the slip speed calculation gives an error in the rotor flux position, it results from it a loss of decoupling. The following figure allows schematizing the strategy of proposed compensation. Continuation has a parametric variation, the vector of the rotor flux will be offsetted as compared to the direct axis by an angle of value  $\Delta\theta_s$ . Figure 1 represents the gap of the rotor flux. We have therefore a difference  $\phi_r \neq \phi_{rd}$ , and:

$$\theta_s' = \theta_s + \Delta\theta_s \quad (13)$$

$\theta_s$  : speed of synchronism in case of DFOC control without parametric variation.

In this work, we propose to make an adjustment of the speed of synchronism in order that the rotor flux is found again exactly on the direct axis d. We will have therefore to use the effect of the parametric variation that appears on the error of the mechanical speed  $e_{\Omega}$ , and to introduce this error in the calculation of the speed of synchronism.

$$e_{\Omega 1} = e_{\Omega} \cdot \left| \Omega_m^{ref} \right| \quad (15)$$

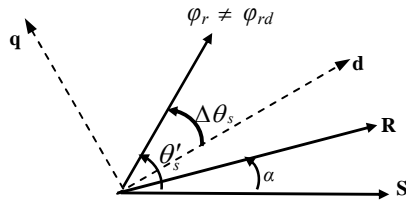

Fig.1: Representative diagram of the loss of decoupling

The diagram of the compensation system is given by the next figure:

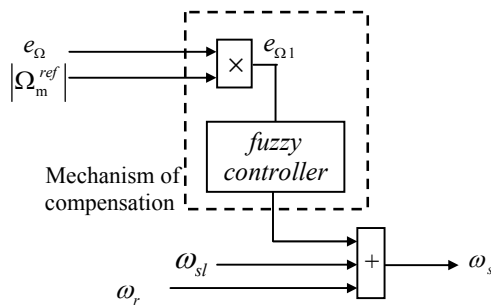

Fig.2: Schematic diagram of the mechanism of compensation

Where  $e_{\Omega}$  is the error between the mechanical speed and its reference:

$$e_{\Omega} = \Omega_m^{ref} - \Omega_m \quad (14)$$

To accelerate the compensation of the speed of synchronism, we use a fuzzy controller [12]. Figure 3 shows the configuration of the fuzzy logic controller with the Mamdani fuzzy inference system [10]. It includes four major blocks: knowledge base, fuzzification, inference mechanism, and defuzzification. The knowledge base is composed of a data and a rule base. The database consists of input and output membership functions.

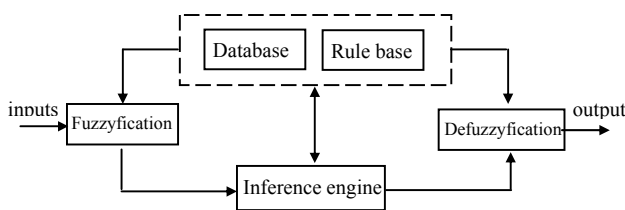

Fig. 3: Structure of a fuzzy controller

The rule base is made of a set of linguistic rules relating the fuzzy input variables into the desired fuzzy control actions. To give the set action, the fuzzy controller uses the error  $e_{\Omega 1}$  given by the product;

The inputs of fuzzy controller are  $e_{\Omega 1} = e$  and its time variation  $de_{\Omega 1} = e_2$  as defined in (16) and (17),

$$e_1 = G_1 (\varphi_r^*(k) - \varphi_r(k)) \text{ and } e_2 = G_2 (e_1(k) - e_1(k)) \quad (16)$$

where  $G_1$  and  $G_2$  are adjustable input gains.

For the successful design of FLC's, proper selection of these gains is a crucial job, which in many cases is done through trial and error to achieve the best possible control performance. The crisp variables are converted into fuzzy variables  $eF$  and  $\Delta eF$  using triangular membership functions as in Figure 4. These input membership functions are used to transfer crisp inputs into fuzzy sets. In the defuzzification stage, the implied fuzzy set is transformed to a crisp output by the centre of gravity defuzzification technique as given by equation (17),  $z_i$  is the numerical output at the  $i$ th number of rules and  $\mu(z_i)$  corresponds to the value of fuzzy membership function at the  $i$ th number of rules.

$$z = \frac{\sum_{i=1}^n z_i \cdot \mu(z_i)}{\sum_{i=1}^n \mu(z_i)} \quad (17)$$

The summation is from one to  $n$ , where  $n$  is the number of rules that apply for the given fuzzy inputs. The crisp output  $y$  is multiplied by the gain factor  $G_3$  to have the set action of the fuzzy controller. A knowledge base of  $3 \times 3$  rules, as shown in Table 1 [12], is applied to reduce the flux error to zero. These fuzzy rules can be understood easily and can be explained intuitively.

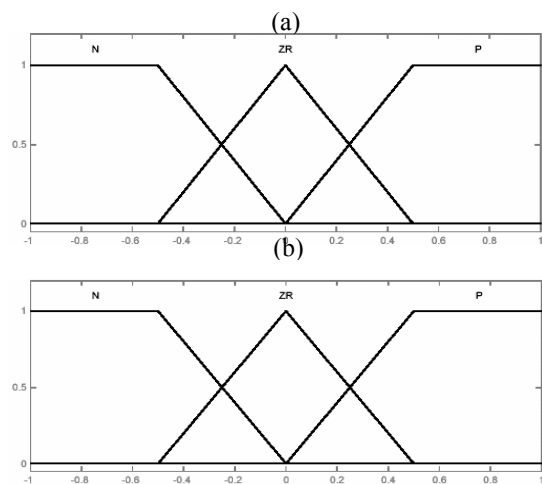

Fig.4: Input and output membership functions (a):  $e_{\Omega 1}$ , (b):  $\Lambda e_{\Omega 1}$

V. SIMULATION OF RESULTS

Simulations, using MATLAB Software Package, have been carried out to verify the effectiveness of the proposed method. The application of the RDFOC is illustrated by a computer simulation shown in the block diagram of Figure 5. We use a PI classic A Classical-Proportional-Integral controllers are used for speed, flux and stator currents loops. The sampling time of simulation is set to 1 ms. The induction motor parameters used in simulation data are given in Table 2. The trajectories of the references speed, flux and load torque are given in Fig.6. Flux reference is set to its rated value of 1Wb.

This benchmark shows that the load torque appears at the nominal speed (157 rad/sec), and the load torque is varied 3 times; at 1.3 sec from 0 to 10 Nm, at 2.6 sec from 10 to 0 Nm, at 5.3 sec from 0 Nm to -10 Nm, and at 6.6 sec from -10 Nm to 0 Nm. Firstly, we use RDFOC control of the induction motor without increase of the rotor resistance  $R_r$ . Secondly; we use RDFOC control of the induction motor with increase of 100% on the rotor resistance. Finally, we use a classic DFOC with the same increase of the rotor resistance, and we compare its results by these obtaining by the RDFOC.

Figures 7, 8, 9 and 10 give results of simulation obtained by the RDFOC control. Figure 7 illustrates the error of mechanical speed of induction motor. Figure 8 shows the load and the electromagnetic torque. Figure 9 and 10 illustrates the errors of observation and regulation of rotor flux

TABLE 1 RULE BASE FOR FLUX CONTROLLER

$eI$	$N$	$Z$	$P$
$N$	$N$	$N$	$Z$
$Z$	$N$	$Z$	$P$
$P$	$Z$	$P$	$P$

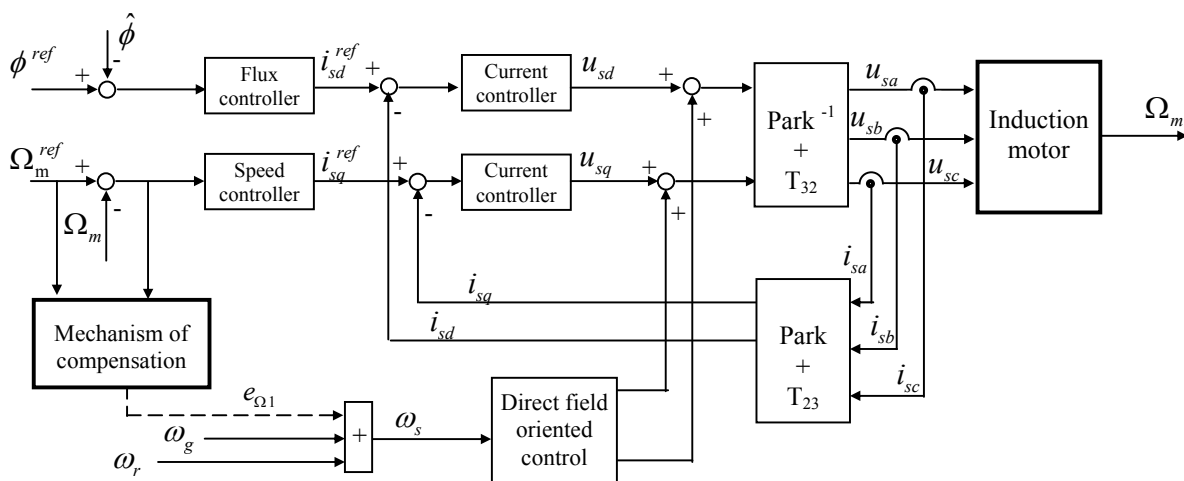

Fig.5. Schematic diagram of Robust Direct Field Oriented Control

TABLE II  
 PARAMETERS OF INDUCTION MOTOR

Parameter	NOTATION	Value
Rotor resistance	$R_r$	3.805
RStator resistance	$R_s$	4.85
Mutual inductance	$M$	0.258 H
Stator inductance	$L_s$	0.274 H
Rotor inductance	$L_r$	0.274 H
Rotor inertia	$J_m$	0.031 kg/m <sup>2</sup>
Pole pair	$p$	2
Viscous friction coefficient	$f_m$	0.008 N·m·sec·rad <sup>-1</sup>
Mechanical power	$P_{max}$	1.5 KW
Nominal voltage	$V_{n_x}$	220 V
Nominal current	$I_{sn}$	3.1 A
Nominal speed	$\Omega_n$	1500 Nm

Figures 11, 12, 13 and 14 give results of simulation obtained by the RDFOC control, with increase of the rotor resistance. Figures 15, 16, 17 and 18 give results of simulation obtained by the DFOC control with increase of the resistance.

A. RDFOC control

Fig.7 shows that speed tracks perfectly the reference without overtaking. The drop in speed after the application or the elimination of the load torque is very small. We note also that a very small static error:  $\Delta\Omega_m = 0.12$  rad/sec is observed during the application of the nominal torque in full nominal speed.

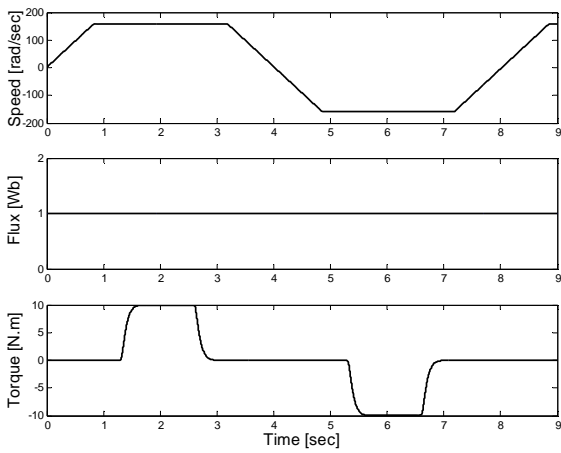

Fig. 6. Reference trajectories

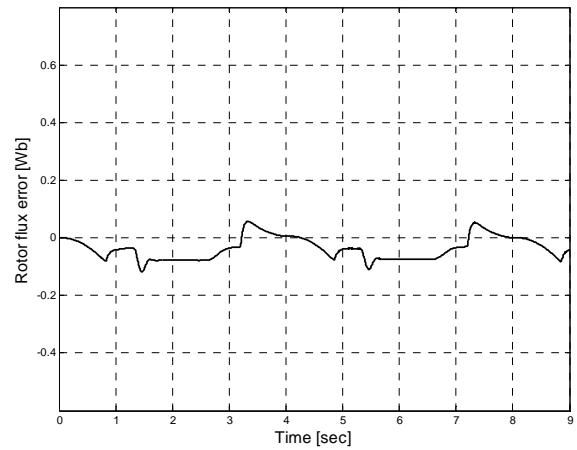

Fig. 9. Observation error of the rotor flux

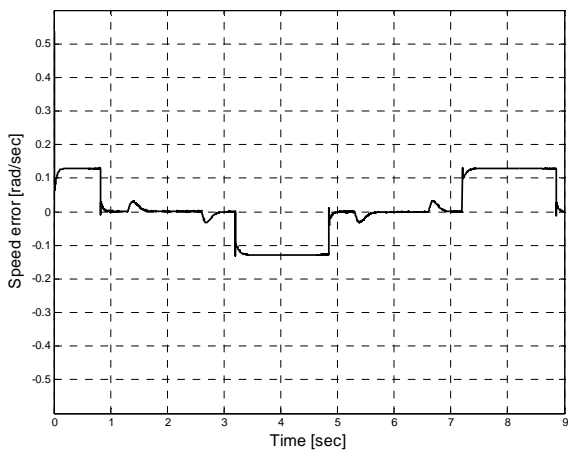

Fig. 7. Speed error tracking

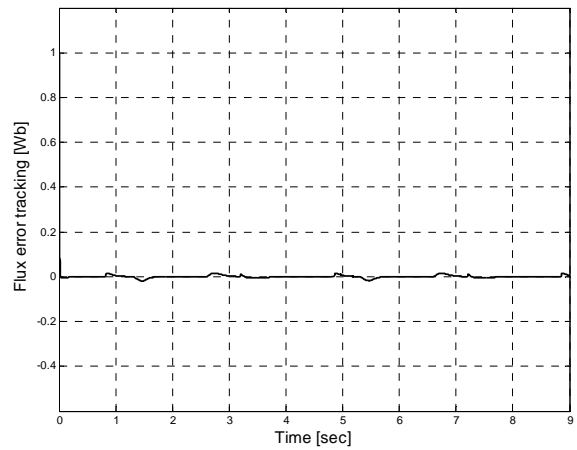

Fig. 10. Rotor flux error tracking

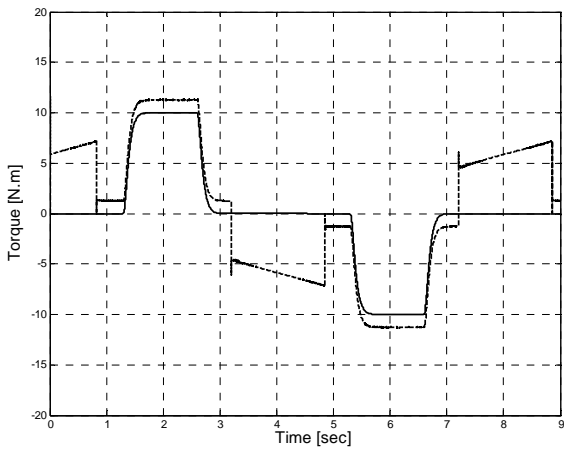

Fig. 8. Motor and load torques

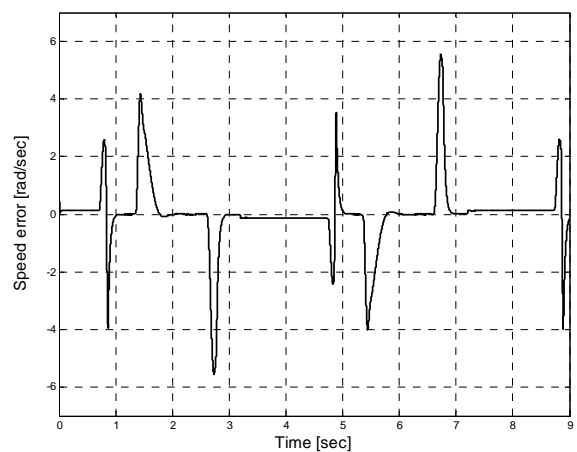

Fig. 11. Speed error tracking

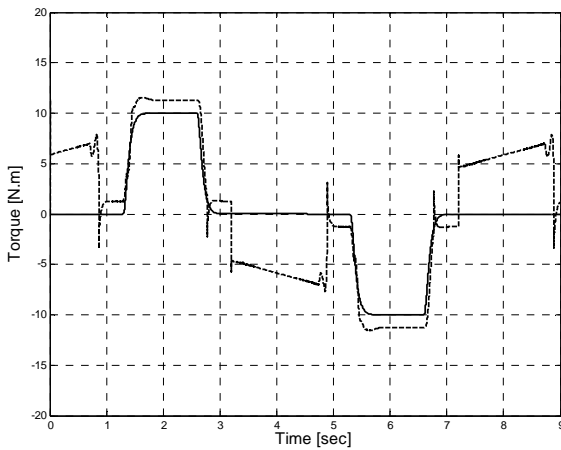

Fig. 12. Motor and load torques

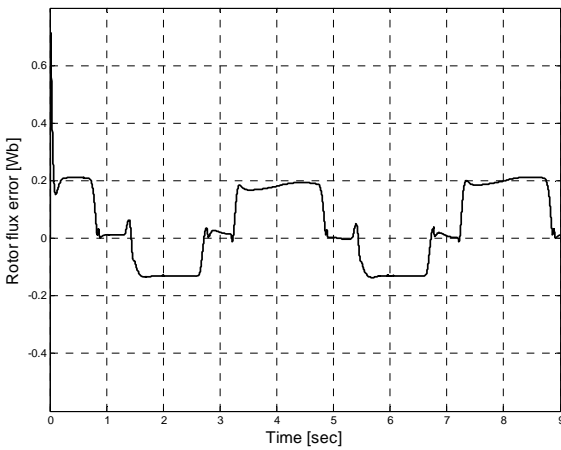

Fig. 13. Observation error of the rotor flux

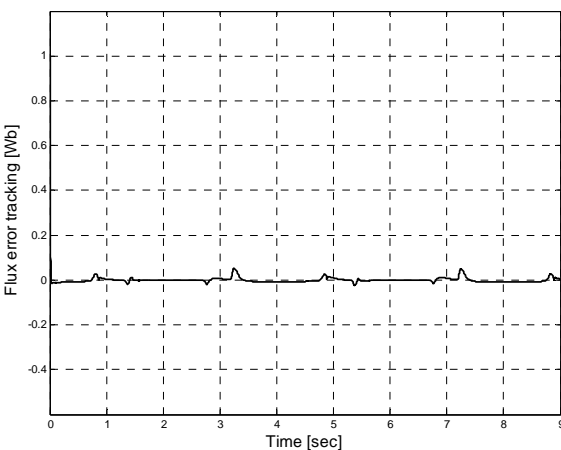

Fig. 14. Rotor flux error tracking

As shown in Fig.8, the drive torque follows the load torque when the speed is constant. During an increase or decrease in the speed, a difference of  $\pm 7$  Nm appears between the two

torques. Figure 9 show a good tracking error of regulation of flux. The desired flux remains constant in the asynchronous machine to satisfy the objectives of the field-oriented control. However, figure 10 shows a little error of flux observation; this error becomes greater when the load torque is applied.

As shown in the Fig.10, the application of the increase of the resistance provides a certain overtaking in the track of the speed, but the static error remains inferior to 0.2 rad/sec.

We note that peaks appear in the response of torque (Fig.12) at the time of the variations of the speed or the load torque. However, the RDFOC allow for keep good regulation of the flux. The effect of variation of the value of the resistance appears mainly in the tracking of the flux observer.

### B. DFOC control

Figure 15 show that the speed tracks the reference with a great static error:  $\Delta\Omega_m = 18$  rad/sec, which appear during the application of the nominal Torque. The drive torque follows the load torque with peaks at the time of the speed and torque variations (Fig.16). We note a great error of regulation and observation of flux as compared to these in the case of the RDFOC control, especially the error of regulation (Figs.17-18).

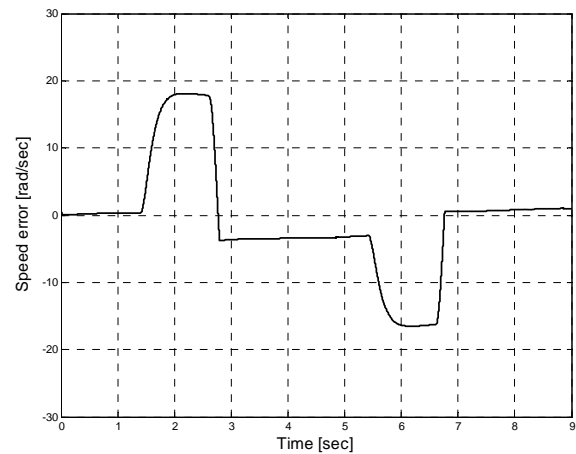

Fig. 15. Speed error tracking

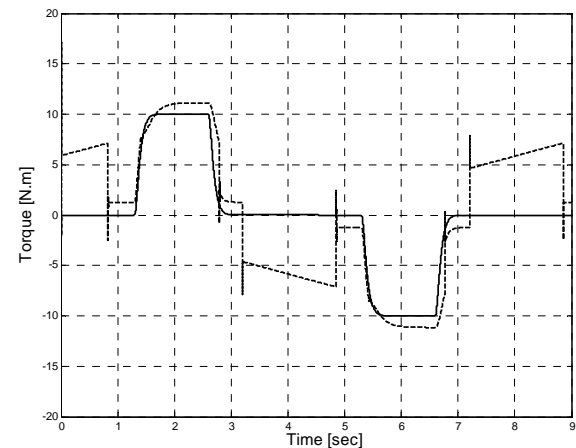

Fig. 16. Motor and load torques

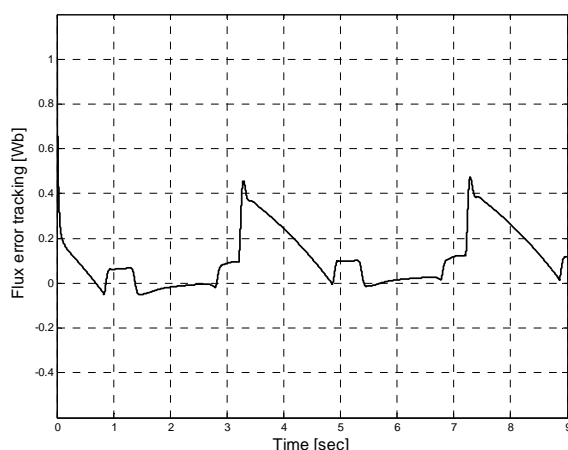

Fig. 17. Observation error of the rotor flux

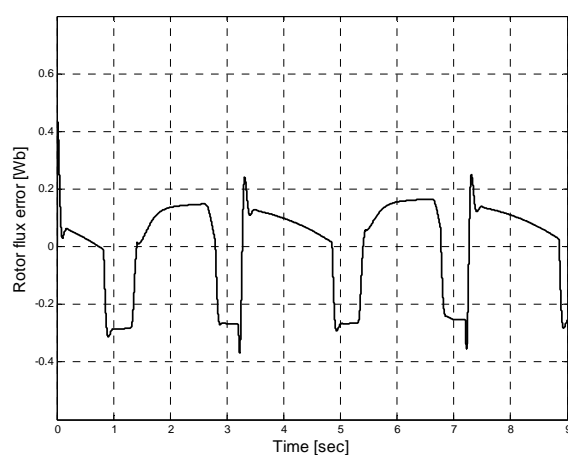

Fig. 18. Rotor flux error tracking

## VI. CONCLUSION

In this paper, we presented a new approach of robust direct field oriented control, based on the compensation of the effects of variation parameters. The approach uses the adjustment of the speed of synchronism for compensate the effect of the variation of rotor resistance. The evaluation regarding the robustness of its performances compared with the traditional direct field oriented control was made when the rotor resistance varied considerably. The results show that the proposed robust controller offers better performances while tracking the torque, speed and the flux, even ahead the increase of the rotor resistance. We hope to perform experiments on-line to validate these theoretical results.

## REFERENCES

[1] I.K. Bousserhane, A. Hazzab. (2006): *Direct field oriented control using backstepping strategy with fuzzy rotor resistance estimator for induction motor speed control*. International Journal of Applied Engineering Research. Vol.1, N1, p. 37-50.

[2] S. Sangwongwanich, S. Doh, T. Yonemoto, S. Okuma. (1990): *Adaptive sliding observers for direct field-oriented control of Induction Motor*. Industrial Electronics Society, 16<sup>th</sup> Annual Conference of IEEE. Vol2, p. 915-920.

[3] G.C Verghese. and S.R. Sanders. (1988): *Observers for flux estimation in induction machines*. — IEEE Trans. Ind. Electron., Vol. 35, No. 1, pp. 85-94.

[4] J. Soltani, Y. Abdolmaleki and M. Hajian. (2005): *Adaptive fuzzy sliding-mode control of speed sensorless universal field oriented induction motor drive*. — Iranian Journal of Science & Technology, Transaction B, Engineering, Vol. 29, No. B4 .

[5] J.P. Caron, J.P. Hautier. (1995): *Modeling and Control of Induction Machine. Technip Edition (text in french)*.

[6] M. A. Ouhrouche and C. Volat. (2000): *Simulation of a Direct Field-Oriented Controller for an Induction Motor Using Matlab/ Simulink*. Proceeding of the IASTED International Conference Modelling and Simulation - Pittsburgh, Pennsylvania, USA.

[7] M. Alamir. (2002): *Sensitivity analysis in simultaneous state/ parameter estimation for induction motors*. Int. J. of Control, vol. 75, n°10, pp. 753-758.

[8] Van Raumer J.M. Dion, L. Dugard and J.L.Thomas. (1994): *Applied nonlinear control of an induction motor using digital signal processing*. IEEE Trans. Contr. Syst. Technol, Vol. 2, No. 4, pp. 327-335.

[9] A. Mansouri, M. Chenafa, A. Bouhenna and E. Etien. (2004): *Powerfull nonlinear observer associated with field-oriented control of an induction motor*. Int. J. Appl. Math. Comput. Sci, Vol. 14, No. 2, 209-220.

[10] E. H. Mamdani and S. Assilina. (1975): *An experiment in linguistic synthesises with a fuzzy logic controller*. International Journal of Man Machine Studies. No 7, p.1-13.

[11] F. Blaschke. (1972): *The principle of field orientation as applied to the new transvector closed loop control system for rotating field machines*. — Siemens Rev, Vol. XXXIX, No. 5, pp. 217-220.

[12] Han-Xiong Li and H. B. Gathaland. (1996): *Conventional Fuzzy-Control and Its Enhancement*. IEEE Trans. on sys. Man , Vol 26, No5.

**T. Benmiloud** was born on January, 14, 1977 in Oran, Algeria. He received his B.S degree in Electrical Engineering and the M.S degree from the University of Sciences and Technology of Oran, Algeria, in 2000, and 2005 respectively. He is currently Student in doctorate in Automatic in the same university. His research interests include Automatic, Electrical machines and Drives Control, Power Electronics, as well as Intelligent Control. He has authored seven technical papers published in international journals and conference proceedings.

He was teaching temporary replacement from October, 2005 till September, 2007 in computing in the faculty of Medicine (INESM) of Oran, Algeria. He was teaching to the Petroleum Algerian Institute in 2009.

**T. Benmiloud, M. A. Denai. (2010)** « *Commande Neuro-floue du Moteur asynchrone* », Revue Internationale de Génie Electronique, RIGEL. Vol N1, Jan 2010. ISSN: 1112-9506- Oran, Algérie.

**T. Benmiloud, A. Omari. (2007)** « *Adaptive neuro-fuzzy inference system for two outputs* », 5<sup>th</sup> International Conference on Electrical and electronics Engineering ELECO'2007. 05-09 Décembre 2007 - Bursa, Turkey.

**T. Benmiloud, A. Omari. (2007)** « *Régulation de la tension d'alimentation du filtre actif parallèle par PI adaptatif* », International Conference on Electrical and electronics Engineering, CIP 2007. 03-04 Novembre, 2007 - Sétif, Algérie.

**A. Omari** received his PhD in Electrical Engineering from the University of Electro-communications in the city of Tokyo, Japan in 2001. He worked in academia and industry. His industrial experience was mainly in the field of mechatronics and robotics. He is currently working as an Associate Professor in the Faculty of Electrical Engineering at the University of Sciences and Technology in the city of Oran in Algeria. His research and teaching interests include: Automatic control, Intelligent mechatronic systems.