

Simulation of Superconducting Nanowire Single-Photon Detector with Circuit Modeling

Seyed Ali Sedigh Zyabari, and A. Zarifkar

Abstract—Single photon detectors have been fabricated NbN nano wire. These detectors are fabricated from high quality, ultra high vacuum sputtered NbN thin films on a sapphire substrate. In this work a typical schematic of the nanowire Single Photon Detector structure and then driving and measurement electronic circuit are shown.

The response of superconducting nanowire single photon detectors during a photo detection event, is modeled by a special electrical circuits (two circuit).

Finally, current through the wire is calculated by solving equations of models.

Keywords—NbN, nanowire meander, superconducting single photon detector, kinetic inductance.

I. INTRODUCTION

SUPERCONDUCTING Nanowire *Single photon detector* (SNSPD) have recently demonstrated 57% detection efficiency [1], jitter of 30 ps [2] and dark counts of 100 counts/s [3]. These devices operate based on the local suppression of superconductivity along a nanowire after the absorption of a photon [4]. By biasing the nanowire with a current close to (but less than) its critical current, the photo-induced suppression in superconductivity leads to the formation of a resistive barrier along the nanowire and results in a measurable voltage pulse across the SNSPD.

In several applications of single-photon-counting detectors, in astronomy and astrophysics [1] or biological fluorescence microscopy [2], an inherent energy resolution would enormously increase the throughput of scientific information. Nowadays energy-resolving superconducting photon-counting detectors are either transition edge sensors [3] or superconducting-tunnel-junction detectors [4]. These detectors are capable of counting near-infrared and visible light photons with an energy resolution of 0.15 eV at a rate of tens of kilohertz. They operate at temperatures less than 300 mK and require a SQUID (superconducting quantum interference device) based readout. For lifetime fluorescence imaging [5] counting rates up to 107 events per second are needed whereas the requirement for the energy resolution is relaxed.

A good compromise between counting rate and energy resolution might be achieved by making use of superconducting nanowire single-photon counters [6]. It is

predicted [7, 8] that these devices have good energy resolving capabilities and an indication of this has been found recently [9].

In this paper we present measurements on the height distribution of such voltage transients for NbN nanowire photon counters in the spectral range from the ultraviolet to the near-infrared. We show that both the distribution mean and its width depend on the photon energy. This allows for photon counting with a modest energy resolution.

II. DEVICE OPERATION

The model of operation of the superconducting nanowire photon counter is concisely outlined. A photon is incident upon a nanowire biased with a direct current near the critical current value above which the material is no longer superconducting. (Fig. 1.a)

A localized hot spot forms where the superconductivity is disrupted by the photon absorption induced heating, and the super current diverts around this spot can be detected electrically. (Fig. 1.b) [4]

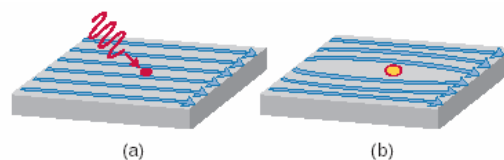

Fig. 1 (a) A photon is incident upon a nanowire biased with a direct current near the critical current value above which the material is no longer superconducting. (b) A localized hot spot forms where the superconductivity is disrupted by the photon absorption induced heating

Fig. 2 is shown a typical schematic of the Nanowire Single-Photon Detector structure: a glass spacer is deposited on top of the NbN detector followed by a gold mirror. The thickness of the spacer is chosen (about 200 nm) such that destructive interference occurs between light reflected from the NbN/sapphire interface and that reflected from the mirror, maximizing the net absorption in the thin film. [4]

Authors are with Islamic Azad University of Iran, Tehran Science and Research Branch, Iran Telecommunication Research Center (ITRC) (e-mail: alisedighzyabari@yahoo.com).

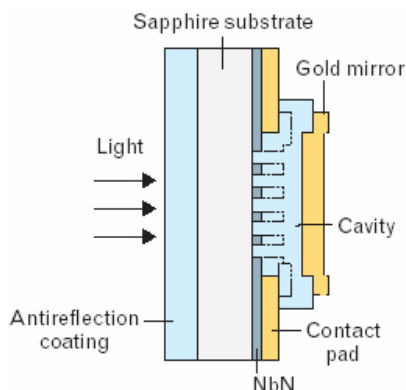

Fig. 2 A typical schematic of the Nanowire Single-Photon Detector structure

A simplified view of the readout circuit is seen in Fig. 3. When an absorbed photon creates a transient resistive section in the detector element, a portion of the bias current is shunted to the amplifier and measured across the 50 input impedance of the microwave amplifier. [5]

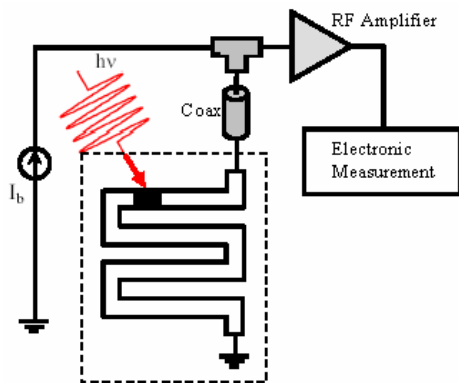

Fig. 3 Driving and measurement circuit

The details of the signal, and in particular the peak height, depend on the normal state sheet resistance of the detector material. The voltage of the peak for the circuit of Fig. 2 (with a 50 ohm) is given by:

$$V = \frac{50 \times R_{hs}}{50 + R_{hs}} I_b \quad (1)$$

Where R_{hs} is the resistance of the normal hot spot created due to the photon absorption.

Fig. 4 is shown effect of one and two photon interaction to the resistance of the NW. If one photon interact the NW, peak of resistant will be 20 ohm and if two photon interact, its peak will be 40 ohm.

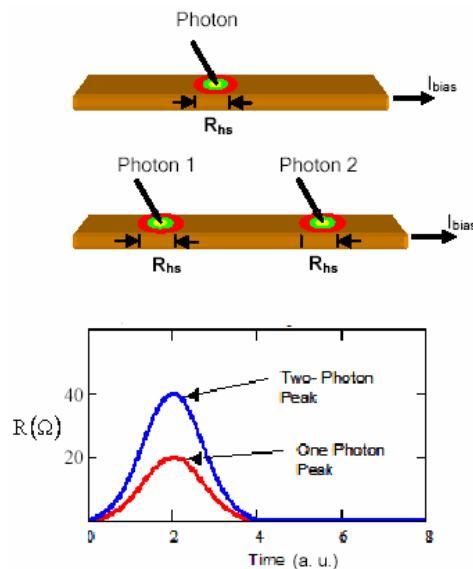

Fig. 4 Effect of one and two photon interaction to the resistance of NW, if one photon interact peak of resistant will be 20 and if two photon interact its peak will be 40 ohm

A large kinetic inductance slows down the detector performance, since the fall time is then determined by $\frac{L_k}{R}$ where R is the 50 input resistance of the amplifier. This means that for a NbN detector with a reasonable area, the photon counting rate will be limited by L_k . Indeed, recent work shows that although fall times were faster than 1 ns for short (5 μm) NbN wires, for 500 μm long meanders, the fall times were ~ 10 ns, thus limiting the reset frequency to approximately 100 MHz, lower than the desired count rate. The long meander was in a $10 \times 10 \mu\text{m}^2$ detector.

The situation is expected to be different for NbN for a narrow superconducting wire [5].

$$L_k = \left(\lambda^2 \cdot \mu_0 \cdot \frac{w \cdot l}{d} \right) \quad (2)$$

Where l is the length of the wire, w is the wire width, d is the thickness, λ is the penetration depth, and μ_0 is the vacuum magnetic permeability.

Electrically, the SNSPD was modeled as an inductor in series with a resistor as shown in Fig. 5. The inductor represented the kinetic inductance of the superconducting nanowire the resistance in series with the inductor was the total resistance formed from a contiguous number of segments that switch into the normal state. [8]

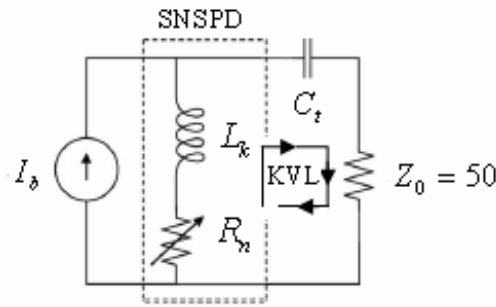

Fig. 5 The SNSPD Electrical model as an inductor in series with a resistor, capacitor was included to represent the AC port. Z_0 is impedance of the transmission line connecting the probe to RF amplifiers

The DC port of the bias tee was modeled as a constant current source and a capacitor was included to represent the AC port. The impedance of the transmission line connecting the probe to RF amplifiers was modeled as a 50 load. We calculate current equation with suitable KVL in the circuit model. The current through the nanowire accepted by solving following equation

$$\begin{aligned}
 -R_n I - L_k \frac{dI}{dt} + \frac{1}{C_t} \int (I_b - I) dt + Z_0 (I_b - I) &= 0 \\
 \Rightarrow \frac{d^2(L_k I)}{dt^2} + \frac{d(R_n I)}{dt} + Z_0 \frac{dI}{dt} &= \frac{I_b - I}{C_t}
 \end{aligned} \quad (3)$$

The calculated current through the wire is shown in Fig. 6. in this curve $R_n \cong 400\Omega$,

$L_k = 800nH, 4,8\mu H$ are assumed. If L_k increases, current of wire will decrease in fix time duration. Temperature of this simulation is very low.

The SNSPD electrical modeled is shown in Fig. 7 in this model resistor of source is considered.

Current equation with suitable KVL in the circuit model is calculated. The current through the nanowire accepted by solving following equation

$$\begin{aligned}
 \left(L_k + \frac{Z_0 \cdot L_k}{R_b} - Z_0 \right) \frac{d^2 I}{dt^2} + \left(R_n + Z_0 + \frac{L_k}{C_t R_b} + \frac{Z_0 R_n}{R_b} \right) \frac{dI}{dt} + \left(\frac{R_n}{C_t R_b} + \frac{1}{C_t} \right) I &= \frac{I_b}{C_t}
 \end{aligned} \quad (4)$$

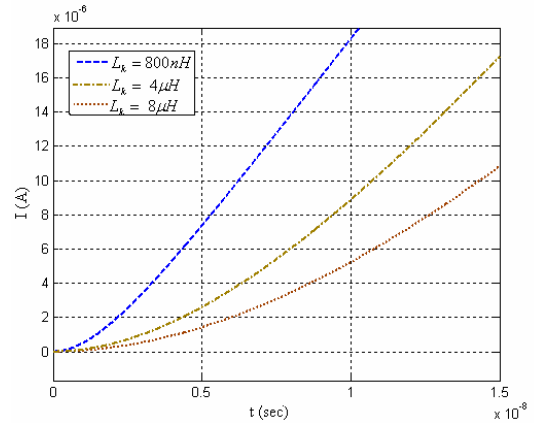

Fig. 6 The calculated current through the wire, in this curve $R_n \cong 400\Omega$, $L_k = 800nH, 4,8\mu H$ are assumed

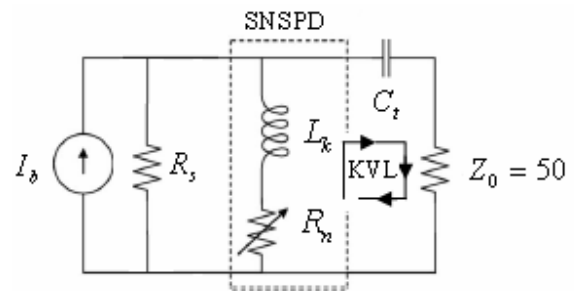

Fig. 7 The SNSPD Electrical model, in this model resistance of DC current source is noticed

The calculated current through the wire, is shown in Fig. 8. In this curve $R_n \cong 400\Omega$, $L_k = 800nH, 4,8\mu H$ are assumed.

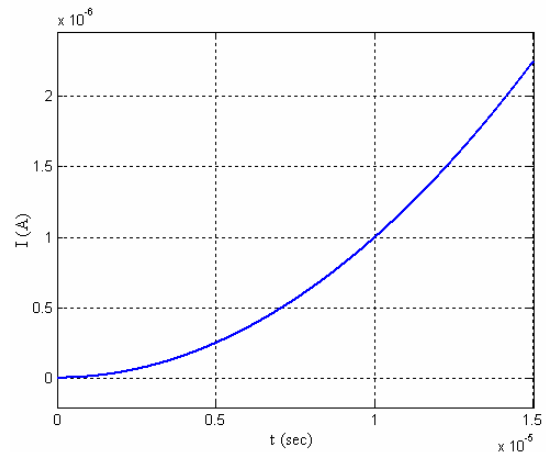

Fig. 8 The calculated current through the wire, in this curve $R_n \cong 400\Omega$, $L_k = 800nH, 4,8\mu H$ are assumed

REFERENCES

- [1] R. H. Hadfield, M. J. Stevens, S. S. Gruber, "Single photon source characterization with a superconducting single photon detector", *Optics Express* 10846, Vol. 13, No. 26, 26 Dec. 2005.
- [2] X. Duan, Yu Huang, R. Agarwal and C. M. Lieber, "Single-nanowire electrically driven lasers", *Nature*, Vol. 421, 16 January 2003.
- [3] J. K. W. Yang, E. Dauler, A. Ferri, A. Pearlman, A. Verevkin, G. Gol'tsman, B. Voronov, R. Sobolewski, W. E. Keicher, and K. K. Berggren, "Fabrication Development for Nanowire GHz-Counting-Rate Single-Photon Detectors", *IEEE Transactions on Applied Superconductivity*, Vol. 15, No. 2, June 2005.
- [4] J. Kerman, E. A. Dauler, B. S. Robinson, R. Barron, D. O. Caplan, M. L. Stevens, J. J. Carney, S. A. Hamilton, and W. E. Keicher, "Superconducting Nanowire Photon-Counting Detectors for Optical Communications", *Lincoln Laboratory Journal* Vol. 6, Number 1, 2006.
- [5] A. J. Annunziata, A. Frydman, M. O. Reese, L. Frunzio, M. Rook, D. E. Prober, "Superconducting niobium nanowire single photon detectors", *Proc. of SPIE* Vol. 6372, 63720V, (2006).
- [6] E. A. Dauler, B. S. Robinson, A. J. Kerman, J. K. W. Yang, K. M. Rosfjord, V. Anant, B. Voronov, G. Gol'tsman, and K. K. Berggren, "Multi-Element Superconducting Nanowire Single-Photon Detector", *IEEE Transactions on Applied Superconductivity*, Vol. 17, No. 2, June 2007.
- [7] A D Semenov, P. Haas, B.G. unther, H-WH"ubers, K Iin, M. Siege, A.K. irste, J. Beyer, D. Drung, T. Schurig and A. Smirnov, "An energy-resolving superconducting nanowire photon counter", *Supercond. Sci. Technol.* 20 (2007) 919-924.
- [8] J. K. W. Yang, A. J. Kerman, E. A. Dauler, V. Anant, K. M. Rosfjord, and K. K. Berggren, "Modeling the Electrical and Thermal Response of Superconducting Nanowire Single-Photon Detectors" *IEEE Transactions on Applied Superconductivity*, Vol. 17, No. 2, June 2007.
- [9] A. J. Kerman, E. A. Dauler, J. K. W. Yang, K. M. Rosfjord, V. Anant, and K. K. Berggren, G. Gol'tsman and B. Voronov, "Constriction-limited detection efficiency of superconducting nanowire single-photon detectors", *arxiv*, physics/0611260v2, 22 Jan 2007.