

Sperm Whale Signal Analysis: Comparison using the AutoRegressive model and the Daubechies 15 Wavelets Transform

Olivier Adam, Maciej Lopatka, Christophe Laplanche and Jean-François Motsch

Abstract—This article presents the results using a parametric approach and a Wavelet Transform in analysing signals emitting from the sperm whale. The extraction of intrinsic characteristics of these unique signals emitted by marine mammals is still at present a difficult exercise for various reasons: firstly, it concerns non-stationary signals, and secondly, these signals are obstructed by interfering background noise.

In this article, we compare the advantages and disadvantages of both methods: AutoRegressive models and Wavelet Transform. These approaches serve as an alternative to the commonly used estimators which are based on the Fourier Transform for which the hypotheses necessary for its application are in certain cases, not sufficiently proven.

These modern approaches provide effective results particularly for the periodic tracking of the signal's characteristics and notably when the signal-to-noise ratio negatively effects signal tracking.

Our objectives are twofold. Our first goal is to identify the animal through its acoustic signature. This includes recognition of the marine mammal species and ultimately of the individual animal (within the species). The second is much more ambitious and directly involves the intervention of cetologists to study the sounds emitted by marine mammals in an effort to characterize their behaviour.

We are working on an approach based on the recordings of marine mammal signals and the findings from this data result from the Wavelet Transform. This article will explore the reasons for using this approach. In addition, thanks to the use of new processors, these algorithms once heavy in calculation time can be integrated in a real-time system.

Keywords—autoregressive model, Daubechies Wavelet, Fourier Transform, marine mammals, signal processing, spectrogram, sperm whale, Wavelet Transform.

I. INTRODUCTION

MARINE mammals emit very unique sounds. These sounds distinguish them from other species but also

Manuscript received Jan 17, 2005. This work was supported in part by the "Association Dirac" (France).

O. Adam is assistant professor. He is with the Laboratoire d'Informatique Industrielle et d'Automatique (LiiA), University Paris XII, Créteil, FRANCE (corresponding author to provide phone: (33)-1-45171774; fax: (22)-1-45171752; e-mail: adam@univ-paris12.fr).

M. Lopatka and C. Laplanche are PhD students with the LiiA, University Paris XII, Créteil, FRANCE (e-mail: maciej.lopatka@xl.wp.pl – laplanche@univ-paris12.fr).

J.F. Motsch is Professor and the director of iSNS in the LiiA, University Paris XII, Créteil, France (e-mail: motsch@univ-paris12.fr).

enable individuals of the same species to be identified. The definition of an acoustic signature is key to identifying an animal but also in the endeavor of behavioral analysis. Our work is compatible with the cetologist's research geared towards tracking an animal (or a group of marine mammals), and aims to correlate their signals to specific life sequences: hunting, social behaviour, mating...

Real-life conditions make the recording of marine mammals difficult [1][2]. The noise-to-signal ratio is often unfavourable.

At present, scientific analysis of sounds emitted by marine mammals follows a classical approach based on the Fourier Transform [3][4][5][6][7]. In order to achieve a time-frequency representation, the spectrogram is of widespread use. It is relatively easy to interpret the obtained results by observing the evolution of frequencies during successive time windows. In addition, the spectrogram is easily applied and currently obtained through fast calculation: in our studies, we use the split radix method to reduce the calculation time. Also, the spectrogram is systematically used in most analyses of marine mammal signals without much attention to strict mathematical hypothesis necessary for its use. The Fourier transform is not optimal when the signal-to-noise ratio is deficient or when signals are extremely brief or staccato. Similarly, the Fourier transform is inadequate for non-stationary and non-linear signals. It is important to be critical, in interpreting the obtained results. While this estimating device can appear perfectly suitable in cases where the sounds contain principal characteristic frequencies (in vocalisation of killer-whales, for example), it can be less adapted to dealing with transitory or even impulsive sounds, as in the case of sperm whales [8][9][10]. Comparisons can be drawn with speech signals in human beings, between the voiced parts (which provide specific frequency peaks known as harmonics formants) and the unvoiced parts (for example plosive or fricative sounds).

In using the Fourier Transform the first step is to find a compromise between time and frequency resolution with the drawback that in favouring one, precision in the other is lost. As for harmonic signals, for which we know, a priori, the range of frequencies, the spectrogram is sufficient for arriving at a first estimation of the frequencies evolution. The mathematic formula is

$$S_x(nT, f) = \left| \int_{nT}^{(n+1)T} x(t)g(t-nT) \exp(j2\pi ft) dt \right|^2. \quad (1)$$

Where $x(t)$ is the signal, $g(t)$ the time window, T and f the coordinates in the time-frequency representation ($n \in Z$). This representation has some drawbacks:

- 1) It is irreversible.
- 2) It often results in an over-sampling of the original signal in order to detect rapid signal fluctuations.
- 3) It does not allow for a time localization in every frequency.
- 4) Data regarding inter-spectral phases is lost.

The above formula (eq. 1) provides a representation of time-frequency. However, the time window length must be determined from the outset. Thus, the approach is less than ideal if we consider that the whole of frequencies varies with time and so it is under and overestimated at random. This is a major disadvantage when dealing with sperm whales as these particular signals are brief and so both rich in frequency and time domains (see figure 1). These sounds are produced through a very unique mechanism: they are pneumatic in origin and the spermaceti figure importantly [11][12][13][14].

The spectrogram of the sperm whales signal (figure 1) is shown in figure 2.

We note the different segments of the click in both figure 1 and 2. In these 2 illustrations, we can distinguish 4 segments; the first being a sequence of impulses of the strongest amplitude; followed by a segment of residue; the third and fourth segments repeating the first two but with lesser amplitude.

To arrive at this spectrogram, we had to choose the two following parameters for the time window: length and shape. The length corresponds to the number of click samplings. This number is actually a compromise between time and frequency precision. We put forth an a priori hypothesis regarding the

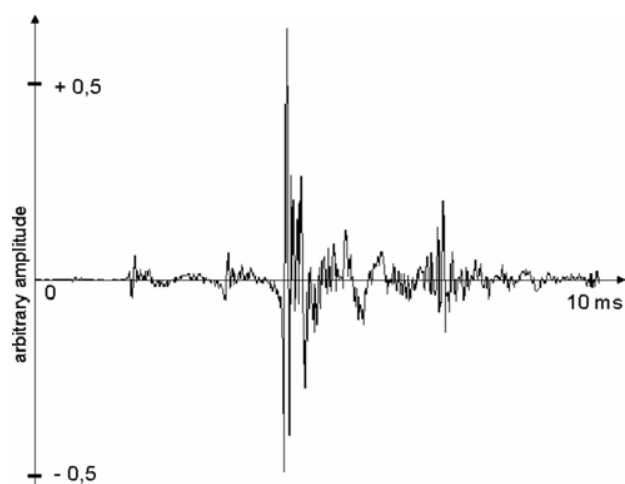

Fig. 1. Sperm whale Click. The above signal illustrates the 4 segments including the first impulse and final residue.

scope of the frequency range. Consequently, we can propose the most appropriate size for the time window reserved for this particular frequency range. The disadvantage is that through this fixing of the time window size, the precision on the higher frequencies deteriorates.

The spectrogram (figure 2) is calculated based on 64 samplings which constitute the shortest time window that can be chosen in order to consider a stationary signal for the length of a millisecond. This choice can be debated when referring to the first (and the third) segment of the click. Other frequency estimators have been defined in signal processing theory to avoid the disadvantages in using the spectrogram [15][16]. We chose to employ the Wavelet Transform [17][18][19]. We will justify this choice in the following section. Then we will illustrate the acoustic signatures obtained through the Wavelet Transform. Before concluding, we will show the results of its performance when adding the noise factor.

II. METHOD

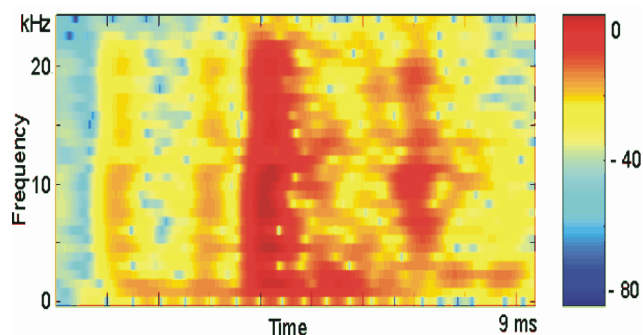

Fig. 2. Spectrogram of the sperm whale click. Above, the spectrogram results from the click recorded and shown in figure 1. In order to calculate this spectrogram we favored time precision (as opposed to frequency precision) by choosing a large time window.

To avoid inaccuracies in time-frequency localisation and compensate for the drawbacks of the spectrogram, different mathematic approaches are defined based on a projection of the signal on various vectors each having different time lengths. The objective of this projection is that it be adaptable to the frequencies we plan to research.

We have chosen the AutoRegressive parametric models (AR models) for the following reasons: firstly, this approach provides a representation of pertinent desired information in a set of coefficients which can then be used either directly in signal analysis or as input in an expert pattern recognition system. Secondly, this model is resistant to noise and can, by tracking coefficients, distinguish the presence of a marine mammal.

We have also chosen the Wavelet Transform. This transform is used with the objective of having a precise time-frequency representation and the resistance to noise.

Following is a presentation of both methods.

A. AutoRegressive Model

The parametric model is an approach used to provide a

representation of time signals [20][21][22]. Essentially, the model is a linear combination of previous signal samples or of a noise. Whether dealing with speech processing, theory of automatic domain, or a prediction of time series, a complete set of models has been defined. The basic formula is the following [20][22]:

$$Y(z) = \frac{z^{-n} B(z)}{A(z)} U(z) + \frac{C(z)}{A(z)} E(z). \quad (2)$$

Where $E(z)$ represents the Adjusted Mean (AM), generally it is a white noise that is used as input in the parametric model; where $Y(z)$ represents the AutoRegressive part (AR), past samples of the time signal are concerned; where $U(z)$ represents the eXogenous part (X): it is an external input, for example, the tendency of a time series or the need for comparison with another series is liable to influence the current model.

Figure 3 provides a graphic illustration of this basic parametric model.

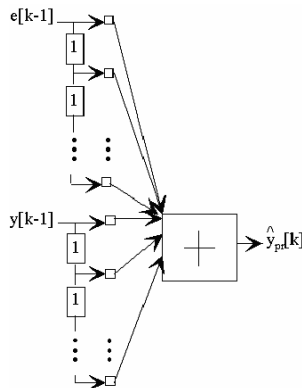

Fig. 3. Design of the ARMA model.

In order to deduce the pertinent signal information in a set of coefficients, it is best to use algorithms which cause the coefficients to converge to where optimal values are attained, according to chosen criteria of error. It is the least square average of error that is commonly used. Many algorithms can be employed; Yule-Walker, Levinson, or adaptive algorithms.

This parametric model is a generalisation of all models used in the identification of a time series. We can deduce which model to use, AR model, MA model or ARX model depending on which of the three inputs described above is more pertinent to the analysis.

We have numerous criteria at our disposal for a subsequent evaluation of these results: converging of the squared error, normalised averaged error, white test of error. In addition we can use Akake criteria also known as Final Prediction Error [23]. It is a criterion which provides a Performance/Complexity ratio:

$$FPE = \frac{N + p + 1}{N - p - 1} e^2. \quad (3)$$

Where N , p are respectively the number of signal samples studied and the number of model parameters (otherwise known as its order). e is the error between signal samples and the values calculated by this model. We note that as the order increases, the criteria increases. Therefore, for a given error, a model having many parameters is considered to be less optimal than a weaker order model.

To summarize, there are 3 steps to carrying out this approach most effectively (see figure 4): selection of model, selection of algorithm, and validation.

This approach has many advantages, particularly as it

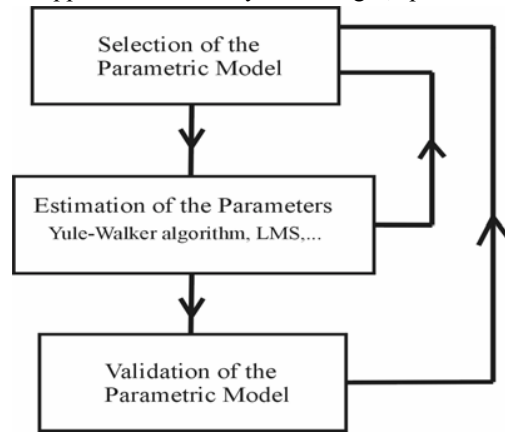

Fig. 4. Parametric approach. After having selected both model and parametric algorithm, the performance has to be evaluated. This method facilitates the selection of the best suited model for the planned application.

corresponds to the original idea that all existing physical processes can be modeled (at least in approximation) through a more or less complicated linear system. In many applications, we have to go further by choosing non-linear models only in instances where the results obtained through parametric models are unsatisfactory [20]. We will take this into consideration in further studies at a later date.

What advantages does this approach provide? We side-step the drawbacks of the Fourier estimator. It is no longer necessary to hypothesize as to the frequency of the analysed signal. It is also no longer necessary to resort to time windows of analysis. Finally, through the use of the adaptive algorithm, it is not necessary to make hypotheses in reference to the stationary nature of the signal. It is certainly this latter argument which is the preponderant for our application: the model coefficients can evolve with each introduction of a new sample making it possible, through analysis of the value of this weight, to distinguish a marine mammal's zones of presence or absence.

Finally, if for the novice, the evolution of coefficients does not provide any results, or the results are too difficult to interpret, one can arrive at the spectral representation using the following formula

$$P_{AR}(f) = \frac{\sigma^2}{|A(f)|^2}, \quad (4)$$

$$\text{with } A(f) = 1 + \sum_k a_k e^{-j2\pi kf}. \quad (5)$$

We note that it is easy to go from time representation to frequency representation (eq. 4). In addition, the model gives a spectrum having finer resolution than that of the Fourier Transform. We also note that modelling the time signal is a question of modelling its spectrum.

Also, as with the spectrogram, one can provide a time-frequency representation. We show the evolution of the spectrum we calculated using each new coefficient value (obtained with each new signal sample, for example). But one can also provide a time-model representation with a direct visualisation of the time evolutions of a set of coefficients. We apply these two modes of representation in our work.

We have chosen to develop this method for use on signals emitted by marine mammals and in particular, by sperm whales, for two principle reasons: firstly, to attribute one model to each individual cetacean and secondly, because it is more resistant to noise than the spectrogram.

Our method provides a satisfactory approximation by presenting a linear model of the process, with a period of calculation which allows one to easily imagine its real-time application.

B. Wavelet Transform

Morlet, for example, introduced time windows of various lengths which are inversely proportionate to the desired frequency. Through his approach, Morlet maintained a time precision with resolution independent of the frequency and did so even for non-stationary signals. The Wavelet Transform [24] is based on the same approach: the result is represented in a time frequency graph of varying resolution. This method provides frequency resolution (through low frequencies analysis) and time resolution (through high frequencies analysis).

As is evident in figure 5, the spectrogram gives a uniform time frequency resolution. The Wavelet Transform resolution

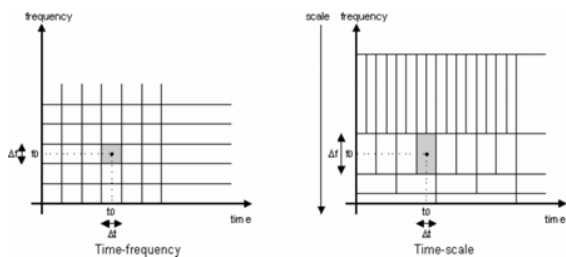

Fig. 5. The time-frequency graph

is contingent on the frequency.

The wavelets analyse finite time signals whose average is zero. Their particular shape is suited to discontinuous signals

or signals with quick impulses. In fact, the results stemming from the Wavelet Transform constitute a multi-scale approach (rather than time-frequency graph, figure 5).

The notion of frequency is replaced by that of *scale*: to consider high and low frequencies, the wavelet $\Psi(t)$ is either contracted or dilated (figure 6). We note that a given wavelet width corresponds to a fixed resolution also called *scale*. Consequently, this wavelet is projected onto the entire length of the signal for analysis.

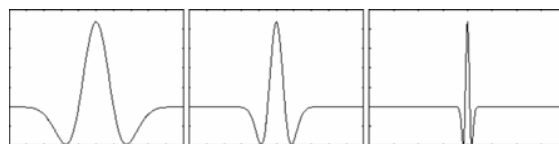

Fig. 6. Dilatation of wavelet. Once a wavelet has been selected (here, the Mexican hat) it is either contracted or dilated in order to consider the presence of all frequencies susceptible to being contained in the signal (highs and lows).

The family of wavelets is created by:

$$\Psi_{mn}(t) = a_0^{-m/2} \Psi(a_0^{-m} t - nb_0) \quad (6)$$

where $m, n \in \mathbb{Z}$; $a_0 > 1$; $b_0 \in \mathbb{R}^+$.

$\Psi(t)$ is called mother wavelet. Another expression is

$$\Psi_{a,b}(t) = \frac{1}{\sqrt{a}} \Psi\left(\frac{t-b}{a}\right), \quad (7)$$

where $\Psi_{a,b}(t)$ is the wavelet obtained from dilatation by using term $a > 0$ and by shifting by using term $b \in \mathbb{R}$ of the mother wavelet $\Psi(t)$. We therefore have two parameters that characterize the wavelet: the scale (or dilation) a , associated with frequency, and the shifting term b , associated with the temporal (time) position. The greater a , the more dilated the wavelet. As a result, the greater values of a will be associated to low frequencies and the lesser values to higher frequencies.

As with all transforms, the obtained coefficients can serve to reconstruct the signal. In our case, they quantify the similarity of the wavelet to the analysed signal. In determining these coefficients we calculate a Continuous Wavelet Transform (CWT). These coefficients allow us to better visualize the signal's content exactly as the representation of the spectre did based on the coefficients of the Fourier Transform.

As regards the CWT, we must calculate the coefficients $C_{a,b}$, as they relate to the signal analysis $x(t)$ over the domain D by the wavelet $\Psi_{a,b}(t)$:

$$C_{a,b} = \langle x, \Psi_{a,b} \rangle_D = \int_D x(t) \overline{\Psi_{a,b}(t)} dt. \quad (8)$$

Even if these coefficients lack physical meaning, their absolute value will be higher than the similarity between $x(t)$ and $\Psi_{a,b}(t)$ will be important.

To calculate a signal's Wavelet Transform, therefore, it is necessary to calculate a series of scalar products to a specific scale at any given time (or the signal's projection onto the wavelet). The steps to follow are

- 1) select a mother wavelet $\psi(t)$;
- 2) select a range of scale factors (values of a) ;
- 3) choose a range for time shifts (values of b) ;
- 4) create a wavelet $\Psi_{a,b}(t)$ for each pair (a,b) and calculate the scaled product to obtain a coefficient $C_{a,b}$.

By sampling the two parameters a and b of the wavelet, the principal is to separate the signal into two components, one representing its general form (also called *approximation*) and the other representing its *details*. This is to say that the general shape of a function is represented by its low frequencies, whereas detail is represented by its high frequencies. It is the same as using 2 filters simultaneously (low and high pass filters).

A wavelet $\psi(t)$ and a scale function of $\Psi_{a,b}(t)$ are associated with each pair of filters. With each transform, we move from a signal length N to two signals of length $N/2$. This is referred to as passing to an inferior resolution. By repeating this method, the whole range of resolutions can be accessed. The minimal decomposition leaves only one value for both the *approximation* and the *details*. In practice, it is in analysing the results obtained through various resolutions that we fix the value of the level of decomposition.

III. RESULTS AND COMMENTS

Following is a presentation of results obtained by using AutoRegressive Models and the Wavelet Transform.

A. AutoRegressive Model

In this section, we will present the results obtained when applying this method, beginning with the research of the model order, coefficients evolution and spectrogram comparisons and finally noise resistance.

After a first analysis of the spectrum of sperm whale clicks,

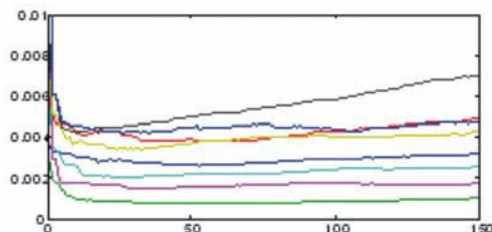

Fig. 7. Application of Akaike criteria. The above value depicts the axis corresponding to the amplitude of Akaike criteria as it pertains to the order of the AR model, of 8 clicks.

we opted to use the AutoRegressive model. We used the FPE Akaike criterion (referred to above) to obtain the optimal

model order (see figure 7).

Figure 7 shows Akaike criteria of less than 5.10^{-3} as soon as the order of AR models is higher than 25. With an order between 25 and 50, the criteria stagnate. It is in this range that we choose our model.

To avoid an unjustifiable increase of time of calculation, we set the order of AR models to 32.

We modelled the click (shown in figure 1): figure 8 shows the evolution of coefficients (on both vertical and horizontal axes) and figure 9 shows the evolution of the spectrum calculated from the coefficients.

Figure 9 is an AR spectrogram illustrating the evolution of

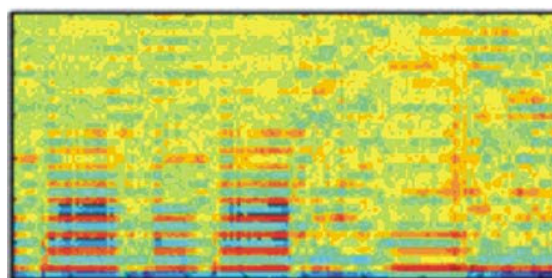

Fig. 8. Evolution of the coefficients. Time is represented on the horizontal axis. The 32 coefficients are on the vertical axis. Their amplitude is projected onto a multicolored scale.

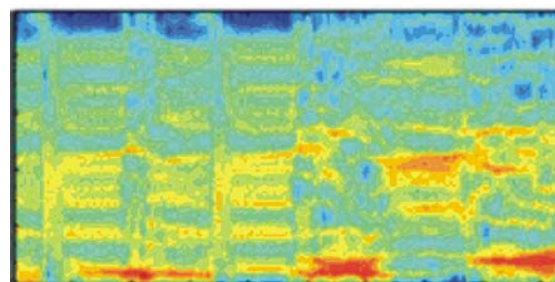

Fig. 9. Evolution of the spectrum. Time is represented on the horizontal axis. The spectrums calculated from the 32 coefficients are represented on the vertical axis. The amplitude is projected onto a multicolored scale.

spectrums with each modification of the model coefficients. In any case, this mode of representation is more easily interpreted by the cetologist. He can identify the frequency evolutions. This mode of presentation is extracted from figure 8 and it engenders increased calculation time. So, in keeping with the objective of building an expert system for detecting automatically the presence of marine mammals, the analysis of coefficients is sufficient and we can bypass this mode of presentation.

We have focused on the resistance factor in our approach for different signal-to-noise ratios (performance levels are kept stable despite the added noise factor). To reiterate, the results obtained by the Fourier spectrogram are not always easily interpreted when the signal-to-noise ratio is very weak. For the purpose of our study, we added white noise to the reference clicks. While this approach is purely theoretical, the

results obtained under unfavourable conditions can serve as a reference point. In practice, we consistently use a filter before recording the signals. Figure 10 and 11 show the results obtained with signal-to-noise ratios equal to 0 and -5 dB.

The influence of added noise is apparent in the preceding two figures. We have established a threshold to keep only the

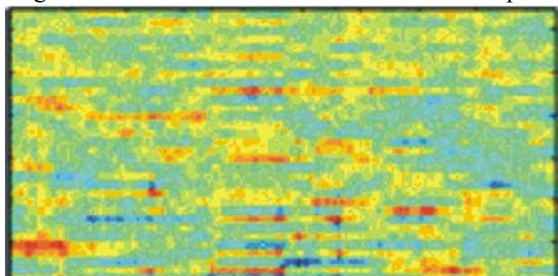

Fig. 10. Scattering of coefficients. White noise has been added. The signal-to-noise ratio is 0 dB.

important coefficients because we believe it necessary to resort to an expert system to treat these signals under unfavourable conditions. This will be the subject of an upcoming publication by our team of researchers.

B. Wavelet Transform

For the purpose of our study, we applied the Daubechies

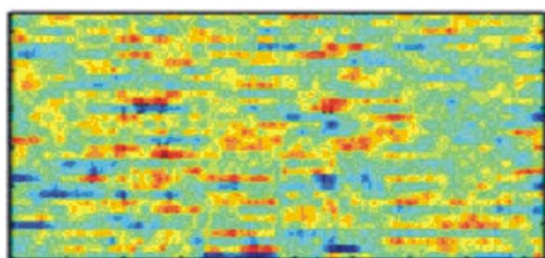

Fig. 11. Scattering of coefficients. White noise has been added. The signal-to-noise ratio is -5dB.

wavelet (order 15) [25]. We chose this wavelet for its great similarity to the shape of the referenced click [19]. We carried out the analysis based on a scale of 1 to 64 (at intervals of 1). The number 1 mark indicates half of the sampling frequency (24 kHz). One can easily distinguish the shape of the time-scale representation of the clicks.

We applied this technique to the click presented in figure 1. Figure 12 depicts the multi-scale representation.

1) *Analysis of the shape 'fanning out'*: In figure 12, we note a fan shape symbolizing the acoustic signature of the emissions from the sperm whale. This shape is the characteristic result of the Daubechies wavelet applied on the sperm whale click. This shape is entirely different from what we can discern through a killer whale's shrill whistling, for example. Thus we have laid out two distinct objectives. The first is to distinguish the species, or indicate when a sperm

whale signal has been detected. This can be done using continuous monitoring mechanisms in a given marine zone, for instance, based on global characteristics that the Wavelet Transform provides. A range corresponding to this opening or fanning out which represents the click needs to be established. We have embarked upon research that would address this. At present, the study has only been applied to a limited number of recorded sperm whales and thus needs to be further explored before it can be validated. Secondly, it is necessary to identify a single sperm whale. We could compare our method of recognition to those of digital impressions: i.e. the superimposing of new findings on those provided in a data base. We chose 10 identical points serving as references to verify the identity of an animal.

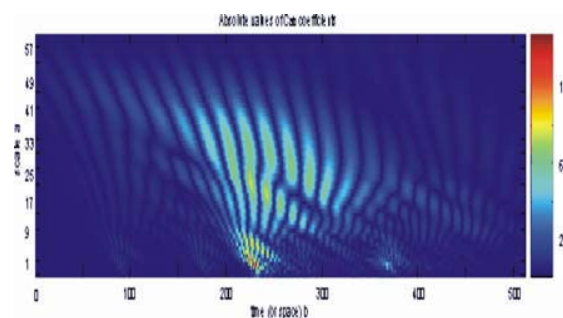

Fig. 12. Wavelet Transform of the sperm whale click. The Wavelet Transform of the click provides a characteristic representation which serves as acoustic signature of the emitted sounds of the sperm whale

2) *Results with addition of noise*: We are interested in the further testing of the Wavelet Transform when we add noise. To this end, we have purposely degraded the signal-to-noise ratio. Note that the spectrogram which has as a base the Fourier estimator is considerably noise sensitive and performance decreases rapidly when the signal-to-noise ratios are unfavorable. In such an instance, the time-frequency representation obtained is essentially non-exploitable.

Figure 13 is of particular interest while it illustrates that even when the signal-to-noise ratio is entirely unfavorable, as with SNR =5 dB, we come back to the acoustic signature of the sound emitted by the sperm whale. Certainly, there are many parasites which can interfere with pertinent information. However, it is entirely feasible that a certain number of particular terms be preserved (number of 'continuous and discontinuous lines' of the fanning out, for instance) which lead us to believe that recognition via the 'digital impression' warrants further analysis. Our studies have shown that it is possible to decrease the SNR to -10 dB all the while preserving a desired level of performance. Further results based on more sperm whale studies should be achieved in order to confirm these levels of performance.

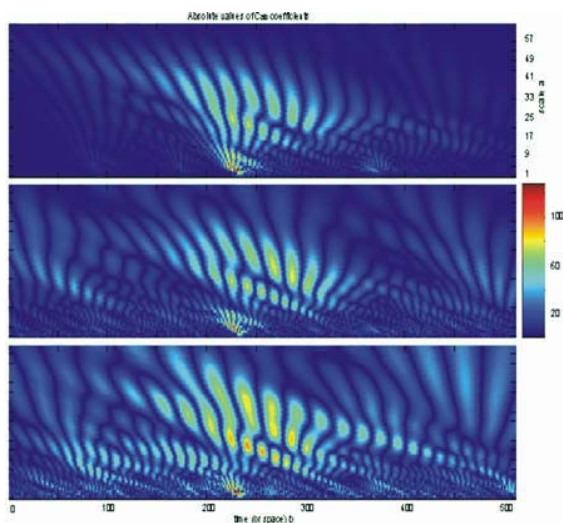

Fig. 13. Resistance to noise. White noise was used. Wavelet Transform results applied to the preceding clicks in the following cases (top to bottom): SNR =5 dB, SNR =0 dB, SNR =-5 dB.

IV. CONCLUSION

With this article, we presented two modern approaches which would avoid the drawbacks of Fourier estimators particularly when the signal-to-noise ratio has deteriorated, as is often the case with marine mammal signals recorded at sea.

Modern technology now allows for other types of real-time representations. We have seen that the parametric model is of interest not only because the algorithms that assure convergence of model coefficients are easily implemented but also because its use is not based on restrictive hypotheses of the Fourier estimators.

We must also mention the potential for calculating frequency representation based on the coefficients, which makes this method easily interpretable even by the novice.

In addition, we have demonstrated other possible uses of coefficients. We can promptly provide a time-evolved representation of these coefficients, as is the practice with the spectrogram.

From the graphic illustration, it is possible to discern the coefficients and to locate an acoustic signature. We can equally see the non-stationary nature for the entire duration of the recording and through this approach classify the ambient noise in a marine zone.

We were also satisfied with the resistance factor of our method when the signal-to-noise ratio changed.

This article also illustrates why the use of the Wavelet Transform for treating sounds emitted from sperm whales is of interest. These emitted sounds are distinctive, notably in their impulsive and brief shape.

Essentially, the Wavelet Transform could have been applied to the signals at several levels. It can serve as (1) a filter which

eliminates noise in recorded data, (2) a compression mechanism to optimise the storing of data, and (3) a projection on the basis vectors for extracting relevant information intrinsic to the sperm whale's signals. It is in this latter case that we applied this transform: our aim being to provide a characteristic representation based on the multi-scale projection, from which we could extract sufficient data to confirm the presence of the sperm whale, the discerned shape of which appears as a fanning out.

What is of particular interest is that these terms are to be used in an approach similar to the analysis of digital impressions.

In addition, this article presents the performance of the Wavelet Transform when we add white noise. We have seen that even for entirely unfavorable signal-to-noise ratios, it is nonetheless possible to detect an acoustic signature. This is encouraging for its use under real conditions, keeping in mind that at sea, noise is always present.

It is possible to envision, at present, a real-time application of this approach using the Wavelet Transform thanks to efficient algorithms and ever progressive processors.

This work will need to be carried out through applications on a greater number of sperm whales to prove thoroughly valid. At present, we can say that the approach could be implemented in a complete system of sperm whale recognition and that it is encouraging for three reasons: it allows for a specific form of an acoustic signature, it is noise resistant and its employment does not impede a real-time application.

This expert system could eventually be based on an artificial neural network [26][27][28]. This second objective is to be realized through extraction of intrinsic characteristics of the sounds emitted by each individual marine mammal followed by the treatment of these findings. A database containing the acoustic signature supplements existing information on those mammals we wish to observe which are living in or passing through the marine zone (transient or resident animals).

ACKNOWLEDGMENT

Signals of sperm whales are taken from the data base of M. André UICMM (*Unidad de Investigación para la Conservación de los Mamíferos Marinos*), University Las Palmas -Gran Canaria.

REFERENCES

- [1] R. J. Urick, *Principles of Underwater Sound*, 3rd ed., Ed. New York: McGraw-Hill, 1983.
- [2] R. F. Coates, *Underwater Acoustic Systems*. Ed. London: McMillan, 1990.
- [3] W. W. L. Au, R. W. Floyd, R. H. Penner, A. E. Murchison, "Measurements of echolocation signals of the Atlantic bottlenose dolphin," *J. Acoust. Soc. Am.*, vol. 56, pp. 128990, 1974.
- [4] D. K. Mellinger, Ch W. Clark, "A method for filtering bioacoustic transients by spectrogram image convolution," *Oceans*, 1993.
- [5] L. A. Miller, J. Pristed, B. Mohl and A. Surlykke, "The click-sounds of narwhales in Inglefield Bay," *Marine Mammal Sci.*, vol. 11, pp. 491-502, 1995.

- [6] I. Tokuda, T. Riede, J. Neubauer and M.J. Owren, "Nonlinear analysis of irregular animal vocalizations," *J. Acoust. Soc. Am.*, vol. 111, pp. 2908–19, 2002.
- [7] G. S. Campbell, R. C. Gisiner, D. A. Helweg and L. L. Milette, "Acoustic identification of female steller sea lions," *J. Acoust. Soc. Am.*, vol. 111, pp. 2920-28, 2002.
- [8] R. Backus, W. E. Schevill, "Physeter clics," *Whales, Porpoises and Dolphins*, Ed. Univ. Calif. by K. S. Norris, pp. 51028, 1966.
- [9] W. Watkins, W. Schevill, "Sperm whale codas," *J. Acoust. Soc. Am.*, vol. 62, 1977.
- [10] B. Mohl, M. Wahlberg, P. T. Madsen, "Sperm Whale Clicks: directionality and source level revisited," *J. Acoust. Soc. Am.*, pp. 638–48, 2000.
- [11] R. Boileau, "Whale soundings," *Zoological Physics*, 438, 2002
- [12] J. C. Goold, S. Jones, "Time and frequency domain characteristic of sperm whale clicks," *J. Acoust. Soc. Am.*, pp. 1279-91, 1996.
- [13] J. C. Goold, J. D. Bennell, S. E. Jones, "Sound velocity measurements in spermaceti oil under the combined influences of temperature and pressure," *Deep-Sea Res.*, vol. 43, pp. 1279-1291, 1996.
- [14] K. S. Norris, G. W. Harvey, "A theory for the function of the spermaceti organ of the sperm whale," *Physeter Catodon*, Ed. Washington DC: Nasa special publications, vol 262, pp. 397-417, 1972.
- [15] W. Lauterborn, U. Parlitz, "Methods of chaos physics and their applications to acoustic," *J. Acoust. Soc. Am.*, vol 84, pp. 1975-93, 1988.
- [16] H. Kantz, T. Schreiber, *Nonlinear Times Series Analysis*, Ed. Cambridge PU, 1997.
- [17] C. Tiemann, M. Porter, L. Frazer, "Automated Model-Based Localization of Marine Mammals near Hawaii" in Proc. of Oceans 2001 Conference, Hawaii 2001
- [18] J. Ward, K. Fitzpatrick, N. DiMarzio, "New algorithms for open ocean marine mammal monitoring," in Proc. of Oceans Conference 2000.
- [19] M. Lopatka, "Reconnaissance de signatures acoustiques pour la distinction d'individus dans un groupe de cachalots," iSnS report, University Paris 12, France, 2002.
- [20] S. Haykin, *Signal Processing*, Ed. IEEE Press, 1994.
- [21] J. Max, *Méthodes et techniques de traitement du signal et applications aux mesures physiques*, Paris: Ed. Masson, 1982.
- [22] ID. Landau, *Identification et commandes des systèmes*, Paris: Ed. Hermes, 1988.
- [23] H. Akaike, "A new look at the statistical model identification," *IEEE Trans. on Auto. Control*, vol.6, pp. 716-23, 1974.
- [24] Y. Meyer, *Les ondelettes, Algorithmes et Applications*, Paris: Ed. Armand Colin, 1992.
- [25] I. Daubechies, *Ten Lectures on Wavelets*, Philadelphia: Ed. Society for Industrial and Applied Mathematics, 1992
- [26] J. Herault, C. Jutten, *Réseaux neuronaux et traitement du signal*, Paris: Ed. Hermes, 1994
- [27] D.E. Rumelhart, G.E. Hinton, R.J. Williams, "Learning representations by back-propagation errors," *Nature*, vol. 323, pp. 533-36, 1986.
- [28] O. Adam, "Approche compare des techniques connexionnistes et adaptatives pour le traitement des signaux lidar," Thesis, University Paris VI, 1995.

Olivier Adam received the electronic engineering diploma and the PhD degree in signal processing from the University Paris 6, Paris, France in 1991 and 1995, respectively. He is Assistant Professor at the University Paris XII since 1995, where he teaches electronics, physics, signal processing and artificial neural network. His research interests include detection, identification and pattern recognition dedicated to biosignal interpretation.

Maciej Lopatka was born in Wodzislaw Slaski, Poland, on December 25, 1978. He received the M. Sc. Degree in Biomedical Engineering from the University Paris XII, France, in 2002 and the MSEE degree from the Technical University of Wroclaw, Poland, in 2003. He is currently working towards the PhD degree in signal processing of the Signal Theory Section, Institute of Telecommunication and Acoustics, Wroclaw, Poland and of the University Paris XII, France. His research interests are in the general field of signal processing with emphasis on detection and identification of non stationary transitory signals, adaptive and orthogonal filtering. M. Lopatka is a student member of IEEE.

Christophe Laplanche received the telecommunication engineer diploma from the Ecole Nationale Supérieure des Télécommunications de Bretagne,

France, in 2002. He is currently working towards the PhD degree in signal processing of the University Paris XII. His research interests include underwater acoustics, whale sounds signal processing and data analysis.

Jean-François Motsch received the Doctorat d'Etat in 1987 from the University Paris XII, France. He is Professor at the University Paris XII since 1992 where he teaches electronics and signal processing. He is the director of the iSnS research team and the president of the Scientific Committee of the Technology Institute. His research interests signal processing and its application for Biomedical.