

Feeder Reconfiguration for Loss Reduction in Unbalanced Distribution System Using Genetic Algorithm

Ganesh. Vulasala, Sivanagaraju. Sirigiri, Ramana. Thiruveedula

Abstract—This paper presents an efficient approach to feeder reconfiguration for power loss reduction and voltage profile improvement in unbalanced radial distribution systems (URDS). In this paper Genetic Algorithm (GA) is used to obtain solution for reconfiguration of radial distribution systems to minimize the losses. A forward and backward algorithm is used to calculate load flows in unbalanced distribution systems. By simulating the survival of the fittest among the strings, the optimum string is searched by randomized information exchange between strings by performing crossover and mutation. Results have shown that proposed algorithm has advantages over previous algorithms. The proposed method is effectively tested on 19 node and 25 node unbalanced radial distribution systems.

Keywords—Distribution system, Load flows, Reconfiguration, Genetic Algorithm.

I. INTRODUCTION

POWER distribution systems typically have tie and sectionalizing switches whose states determine the topological configuration of the network. The system configuration affects the efficiency with which the power supplied by the substation is transferred to the load. Power companies are interested in finding the most efficient configuration, the one which minimizes the real power loss of their three-phase distribution systems. It was estimated that distribution systems cause a loss of about 5–13% of the total power generated [1] in developing countries.

In [2]-[3] a branch exchange method was used in which approximate formulae provide the change in loss due to feeder reconfiguration. Shirmohammadi and Hong [4] proposed a technique in which the switches were opened one by one beginning from a fully meshed system, based on an optimal flow pattern. Goswami and Basu [5] proposed an algorithm based on optimal flow pattern, of a single loop, formed by closing a normally open switch, and the switch with minimum current was opened. Taylor and Lubkeman [6] developed an

expert system using heuristic rules to shrink the search space for reducing the computation time. Glaomocanin [7] used a quadratic programming technique to solve the reconfiguration problem. Wagner et al. [8] proposed a linear programming method and a heuristic search method. Borozan et al. [9] presented a method similar to that of [2]-[3], for solving reconfiguration problem. Compensation based power flow method was used to obtain power flow solution for meshed system. A survey on reconfiguration was presented in [10]. Sarfi et al. [11] developed a method based on partitioning the distribution system into group of load buses, such that the line section losses between groups of nodes were minimized.

Roytelman et al. [12] presented a heuristic-based two stage solution approach, in which weights were assigned to multi-objective functions. In [13]-[14], algorithms for distribution system switch reconfiguration and capacitor control have been proposed. McDermott et al. [15] proposed a constructive heuristic method that started with all switches open, and at each step, the switch that resulted in the least increase in the objective function was closed. Chen and Cho [16] presented an approach to derive optimal switching plan to achieve energy loss minimization, for short and long-term operation of distribution systems. Zhou et al. [17] proposed a heuristic approach for reconfiguration, which reduced operating cost over a specified time period. Schmidt et al. [18] formulated the problem as mixed integer, nonlinear optimization problem. Newton method is used to compute branch currents within the integer search.

In [19], a method was proposed to determine the configuration with minimum energy loss for a given period. In [20]–[23], solution strategies have been proposed for feeder reconfiguration using simulated annealing. Morton et al. [24] developed graph-theoretic techniques involving semi-sparse transformations of a current sensitivity matrix. In [25]–[31], different approaches were presented to obtain minimum loss configuration of the distribution system using genetic algorithm. Hsiao, Y.T [32] developed algorithms based on multi objective evolution programming method for feeder reconfiguration. A heuristic method for three-phase unbalanced systems was proposed in [33] based on approaches in [3, 4]. Wang et al. [34] proposed an algorithm to minimize loss and load balancing for a large-scale unbalanced system using network reconfiguration. In this method, explicit loss formulae were developed for determination of switching operations.

Ganesh. Vulasala is with the Jawaharlal Nehru Technological university, Anantapur, Andhra Pradesh, India. 515002. (corresponding author to provide phone: +91-94411-09230; fax: +91-8568-212314; e-mail: gani_vg@yahoo.com).

Sivanagaraju. Sirigiri, was with Jawaharlal Nehru Technological University, Kakinada, Andhrapradesh, India. (e-mail: sirigiri70@yahoo.co.in).

Ramana. Thiruveedula is with the VRSYRN College of engineering and Technology, Chirala, Andhra Pradesh, India. (e-mail: tramady@yahoo.co.in).

It can be seen from the literature heuristic based method has been proposed for the problem under consideration. Hence, there appears to be a need for developing a simple reconfiguration method using GA for unbalanced systems. In this paper, a GA is presented for reconfiguration of unbalanced distribution systems for loss minimization. A simple method for determining the open/closed states of sectionalizing and tie switches to achieve loss reduction is explained. The performance of proposed method is tested with two different unbalanced radial distribution systems consisting of 19 and 25 node unbalanced radial distribution systems.

In this work distribution system considered as three-phase three wire line sections and all of them are phase-symmetrical, but bus loads may not be equal for all phases. Therefore, the distribution network should be treated as unbalanced. The goal of this work describes a simple reconfiguration method for unbalanced radial distribution systems for loss minimization has been proposed, which is reasonably simple. The effectiveness of the proposed method has been compared with the methods of Shirmohammadi and Hong [4] and Goswami and Basu [5] in respect of switching and loss reduction.

II. PROBLEM FORMULATION LOSS MINIMIZATION

In the radial distribution system, each radial feeder is divided into load sections with sectionalizing switches and is connected to other feeders via several tie switches. The distribution systems loss minimum reconfiguration problem is to decide the position of sectionalizing switches to obtain the best minimum distribution losses with satisfying the following constraints. This problem can be formulated as

$$\text{Minimize } f = \sum_{j=1}^{nb} P_{\text{loss } j}^{abc} \quad (1)$$

where,

nb is the number of branches

$P_{\text{loss } j}^{abc}$ is the loss in branch j

Subject to the following constraints

i. Radial network constraint

Distribution network should be composed of radial structure considering operational point of view.

ii. Power source limit constraint

The total loads of a certain partial network cannot exceed the capacity limit of the corresponding power source.

$$P_s^{abc} \leq P^{max} \quad (2)$$

$$Q_s^{abc} \leq Q^{max} \quad (3)$$

iii. Voltage constraint

Voltage magnitude at each bus must lie with their permissible ranges to maintain power quality.

$$V_q^{min} \leq V_q^{abc} \leq V_q^{max} \quad (4)$$

iv. Current constraint

Current magnitude of each branch must lie within their permissible range.

$$I_j^{abc} \leq I_j^{max} \quad (5)$$

In the network reconfiguration problem the load flow study is required to calculate the overall real power loss for a given system configuration in order to rank it against other configurations.

A. Three phase Load flow

In a three phase unbalanced load flow of distribution system the following components are modeled by their equivalent circuits in terms of inductance, capacitance, resistance and injected current.

Conductors – Individual phase representation for both primary and secondary with capacitive line charging on primary conductor only.

Transformers – A general approach is recommended where by all transformer connections, including the common core transformer, are represented as individual transformers.

Capacitors – Capacitors are represented by their equivalent injected currents.

Loads – The unbalanced loads are basically considered because of single phase, two phase and unequal three phase loads which exist in different types viz. constant power, constant Impedance and constant current.

Shunt admittance and series impedance are represented by the actual phase quantities.

B. Forward- Backward Sweep Load Flow Method

There are several power flow methods based on forward/backward sweep technique. They may be classified as power summation methods and current summation methods. current summation method is used in this paper as it is more convenient and fast than power summation method because it uses only 'V' and 'I' instead of P and Q.

C. Backward Sweep

The purpose of the backward sweep is to update branch currents in each section, by considering the previous iteration voltages at each node. During backward propagation voltage values are held constant at the values obtained in the forward path and updated branch currents are transmitted backward along the feeder using backward path. Backward sweep starts from extreme end branch and proceeds along the forward path. Fig. 1 shows phase a of a three-phase system where lines between nodes p and q feed the node q and all the other lines connecting node q draw current from line between node p and q .

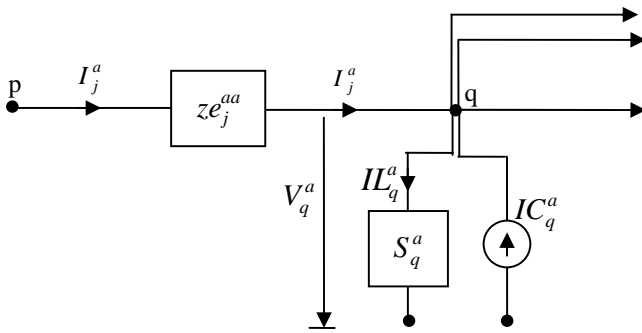

Fig.1. Single phase line section with load connected at node q between to phase 'a' and neutral n .

The parent branch current feeds the load at the q^{th} node and the sub-laterals connected to the parent branch. This current can be calculated using Eqn. (6).

$$I_j^{abc^k} = IL_q^{abc^k} + \sum_{m \in M} I_m^{abc^k} + \sum_{m \in M} \left(Y_{sh}^{abc^k} \right) \left(V_q^{abc^{k-1}} \right) \quad (6)$$

Where

$Y_{sh}^{abc^k}$ is the half line shunt admittance of the branch in k^{th} iteration.

$I_j^{abc^k}$ is the branch current vector in line section j in k^{th} iteration.

$I_m^{abc^k}$ is the current vector in branch m before updating in k^{th} iteration.

$V_q^{abc^{k-1}}$ is the voltage vector of the branch m in $(k-1)^{th}$ iteration.

M represents the set of line sections connected to j^{th} branch. If capacitor bank is placed at the receiving end of the branch then capacitor current should also be included.

D. Forward Sweep

The purpose of the forward sweep is to calculate the voltages at each node starting from the source node. The source node voltage is set as 1.0 per unit and other node voltages are calculated as

$$V_q^{abc^k} = V_p^{abc^k} + Z_e^{abc} \left(Y_{sh}^{abc} V_p^{abc^k} - I_j^{abc^k} \right) \quad (7)$$

Where

$V_q^{abc^k}$, $V_p^{abc^k}$ are the voltage vectors of phases for p^{th} and q^{th} nodes respectively in k^{th} iteration

$$Z_e^{abc} = \begin{bmatrix} z_e^{aa} & z_e^{ab} & z_e^{ac} \\ z_e^{ba} & z_e^{bb} & z_e^{bc} \\ z_e^{ca} & z_e^{cb} & z_e^{cc} \end{bmatrix}$$

$I_j^{abc^k}$ is the current vector in j^{th} branch in k^{th} iteration

These calculations will be carried out till the voltage at each bus is within the specified limits. At this point the voltages at each node, and the currents flowing in all line segments are known, which are used to find the power losses in each line segment.

Therefore the real and reactive power losses in the line between nodes p and q may be written as:

$$S_j^{abc} = \left(V_p^{abc} - V_q^{abc} \right) \left(I_j^{abc} \right)^* \quad (8)$$

Where S_j^{abc} is a vector of power loss with three, two or

single phase V_q^{abc} and V_p^{abc} are voltage vector of three phases at nodes p and q

I_j^{abc} is the branch current vector of three phases for the section connected in between p^{th} and q^{th} nodes

II. SOLUTION METHODOLOGY

Feeder reconfiguration is performed by opening/closing two types of switches; tie and sectionalizing switches. A whole feeder or part of a feeder may be served from another feeder by closing a tie switch linking the two while an appropriate sectionalizing switch must be opened to maintain radial structure. In the context of loss reduction, the problem to be addressed in this article is to identify tie and sectionalizing switches that should be closed and opened, respectively, to achieve minimize the system real losses. Genetic Algorithm (GA) is used to obtain the solution for reconfiguration of radial distribution systems to minimize the losses. The change in the losses can easily be computed from the results of two load flow studies simulating the system configurations before and after the feeder reconfiguration.

III. IMPLEMENTATION OF GENETIC ALGORITHM

A. Chromosome Coding Strategy

Encoding strategies are methods, which effect genetic operations especially during crossover. Most of available GA applications in power systems are simply employing GA and no special attention has been put on the characteristic of the solved problem, modeling and solving technique. In fact, the most critical problem in applying a GA is to find a suitable encoding method for chromosomes in the problem domain. A good choice of chromosome coding will make the search easy by limiting the search space. A poor choice will result in a

large search space and divergence. There are two basic principles for choosing a GA coding: The first principle is to select encoding such that the building blocks of the underlying designer small and relatively unrelated to building blocks at other positions. The second principle states that the user should select the smallest alphabet that permits an expansion of the design so that the number of exploitable schemes is maximized. In the following section, by making use of radial feature of distribution systems, a GA based algorithm is proposed.

B. Shorten the Length of the Chromosome

To maintain continuous power supply to all the loads, the following set of rules to be adopted for selection of switches.

Rule 1: All switches that do not belong to any loop are to be closed.

Rule 2: All switches connected to the sources are to be closed.

Rule3: Sectionalizing switches, those lie on primary side of the tie switches, are taken as opening options of the initial configuration.

Rule4: Selection of sectionalizing switches to be opened is done by taking any one switch among the available set of switches for a particular tie switch closed.

C. Genetic Operations

In this algorithm, Roulette wheel selection method is employed. This method has more advantages compared to random selection. Since here selection is implemented as a linear search through Roulette wheel with slots weighted in proportion to string fitness values. Here chromosomes are ranked in ascending order according to their fitness values. The individual with best fitness are adopted the individual with best fitness are obtained for next generation. In this proposed algorithm crossover operations are defined as to exchange between templates while mutation operations are restricted within the template.

D. Reproduction

For selecting the parents to perform crossover, Roulette wheel selection has been adopted as it gives best results than random selection. In this process fitness of each string is calculated, sorted in ascending order and then according to their fitness, parents are selected to crossover.

E. Crossover

The uniform crossover process randomly selects two parents to exchange the bits of chromosome with a crossover rate P_c i.e. a random number in the range [0 1] is generated. If that value is less than P_c , a mask is generated with the length equal to string length. If bit of mask is 1 particular bit is exchanged between two parents.

Before crossover	After crossover
10101	11110
01110	00101
Mask	01011

F. Mutation

Mutations are restricted in one string. Mutation is the occasional random alteration of value of string position i.e., changing a 1 to 0 and vice versa. In the proposed method, a

random number between 0 and 1 is generated if that number is less than P_m and bits of particular string are altered. Of course, loops might share branches in complicated power distribution system and templates may overlap, these overlaps are eliminated in this algorithm. In this situation, feasible solutions produced during GA operation and mute individual will be discarded.

G. Fitness

The fitness should be capable of reflecting the objective and directing the search towards optimal solution. Load flow calculation is performed to obtain total active power loss. Reciprocal value of total active power loss is proposed as fitness function to obtain optimal active power loss. So maximization of fitness function of the GA can be written as

$$\text{Maximize } F = \frac{1}{1+f} \quad (9)$$

$$\text{Where } f = \sum_{j=1}^{nb} P_{\text{loss } j}^{abc}$$

IV. ILLUSTRATIVE EXAMPLES

The performance of the proposed method is evaluated on two test systems of unbalanced radial distribution system to minimize the power loss by network reconfiguration. The proposed method is illustrated with two test systems consisting of 19 node and 25 node unbalanced radial distribution systems.

A. Example - 1

The 11 kV, 19 node unbalanced radial distribution system with base reconfiguration is shown in Fig. 2. Base MVA for 19 node unbalanced radial distribution system is 1 MVA. The line, load and tie switch data are given in appendix A1. The normally opened switches are s19 and s20. The GA control parameters selected are length of chromosome (12), population size (20), cross over probability (0.8), and mutation probability (0.04).

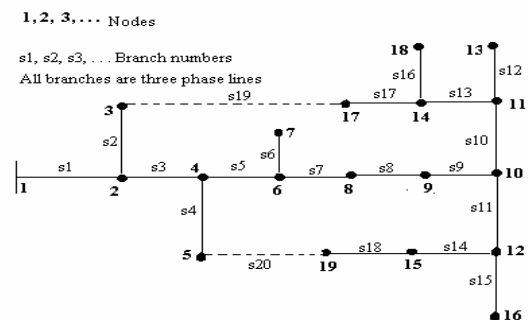

Fig. 2 Single line diagram of 19 node URDS before network reconfiguration

Voltage profile and summary of test results of 19 node URDS before and after network reconfiguration are given tables 1 and 2 respectively. From tables 1 and 2, it has been observed that the minimum voltage in phases A, B, C are improved from 0.9516, 0.9498 and 0.9505 to 0.9703, 0.9694

and 0.9690 p.u and the active power loss in phases of A, B and C are reduced from 4.45, 4.45 and 4.56 kW to 2.83, 2.53 and 2.86 kW respectively. Hence, there is an improvement in the minimum voltage and reduction in power loss when compared with the before network reconfiguration and after network reconfiguration.

TABLE I
 VOLTAGE PROFILE OF 19 NODE URDS

Node No.	Before Reconfiguration			After Reconfiguration		
	V _a (p.u)	V _b (p.u)	V _c (p.u)	V _a (p.u)	V _b (p.u)	V _c (p.u)
1	1.0000	1.0000	1.0000	1.0000	1.0000	1.0000
2	0.9875	0.9891	0.9880	0.9876	0.9893	0.9881
3	0.9854	0.9887	0.9863	0.9814	0.9850	0.9809
4	0.9824	0.9839	0.9830	0.9838	0.9853	0.9849
5	0.9820	0.9837	0.9828	0.9820	0.9834	0.9833
6	0.9793	0.9808	0.9801	0.9826	0.9842	0.9841
7	0.9786	0.9803	0.9796	0.9819	0.9837	0.9836
8	0.9728	0.9738	0.9735	0.9807	0.9821	0.9827
9	0.9659	0.9660	0.9657	0.9793	0.9801	0.9813
10	0.9563	0.9555	0.9550	0.9787	0.9793	0.9809
11	0.9550	0.9543	0.9533	0.9741	0.9778	0.9702
12	0.9548	0.9538	0.9536	0.9716	0.9716	0.9734
13	0.9544	0.9534	0.9521	0.9735	0.9769	0.9690
14	0.9545	0.9539	0.9528	0.9744	0.9781	0.9708
15	0.9527	0.9512	0.9513	0.9745	0.9748	0.9758
16	0.9534	0.9515	0.9522	0.9703	0.9694	0.9720
17	0.9537	0.9534	0.9523	0.9765	0.9804	0.9742
18	0.9538	0.9532	0.9521	0.9738	0.9775	0.9701
19	0.9516	0.9498	0.9505	0.9772	0.9778	0.9787

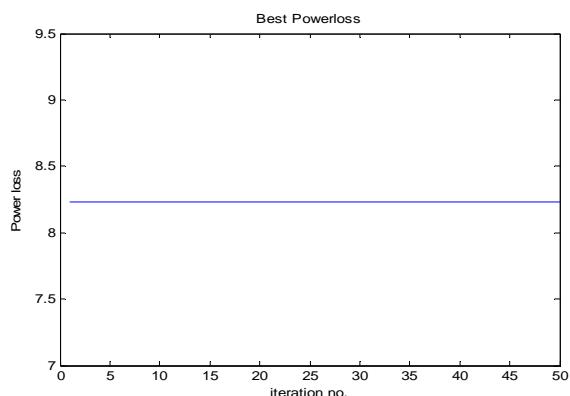

Fig. 3 Total Active power loss Vs Generation number of 19 node URDS

1, 2, 3, ... Nodes

s1, s2, s3, ... Branch numbers

All branches are three phase lines

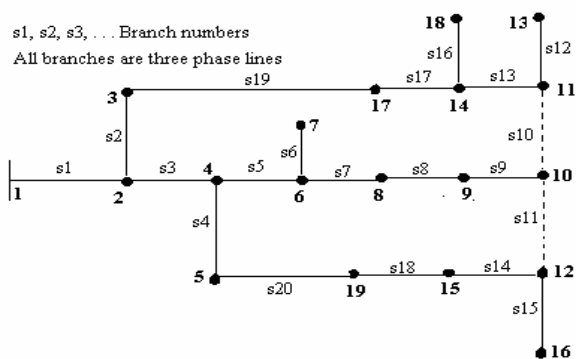

Fig. 4 Single line diagram of 19 node URDS after network reconfiguration

TABLE II
 SUMMARY OF TEST RESULTS OF 19 NODE URDS

Description	Before Reconfiguration			After Reconfiguration		
	Phase a	Phase b	Phase c	Phase a	Phase b	Phase c
Open Switches	s19, s20			s10, s11		
Minimum Voltage	0.9516	0.9498	0.9505	0.9703	0.9694	0.9690
Max. Voltage regulation (%)	4.84	5.02	4.95	2.97	3.06	3.1
Improvement of Max. Voltage regulation (%)	-	-	-	38.63	39.04	37.37
Total Active Power Loss (kW)	4.45	4.45	4.56	2.83	2.53	2.86
Total Active Power Loss reduction (%)	-	-	-	36.40	43.14	37.28
Total Reactive Power Loss (kVAr)	1.94	1.89	1.95	1.27	1.10	1.16
Total Reactive Power Loss reduction (%)	-	-	-	34.53	41.79	40.51
Total Active Power Demand (kW)	126.33	116.24	123.27	124.71	114.32	121.57
Total Released Demand (kW)	-	-	-	1.62	1.92	1.7
Total Reactive Power Demand (kVAr)	61.23	56.34	59.7	60.56	55.55	58.91
Total Released Reactive Power Demand (kVAr)	-	-	-	0.67	0.79	0.79
Total Feeder Capacity (kVA)	140.38	129.17	136.96	138.63	127.10	135.09
Total Released Feeder Capacity (kVA)	-	-	-	1.75	2.07	1.87

The normally opened switches are s19 and s20 before reconfiguration and after reconfiguration the open switches are s10 and s11 for 19 node unbalanced radial distribution system. From table 2 it is observed that the percentage reduction in active power loss after reconfiguration is 38.90%. The total active power loss Vs generation number for 19 node URDS is shown in Fig. 3. Reconfigured network of 19 node unbalanced radial distribution system is shown in the Fig. 4.

B. Example - 2

The 4.16 kV, 25 node unbalanced radial distribution system consists of three tie lines base reconfiguration is shown in Fig. 5. Base MVA for 25 node unbalanced radial distribution system is 30 MVA. The line, load and tie switch data are given in appendix A2. The normally opened switches are s25, s26 and s27. The GA control parameters selected are length of chromosome (12), population size (20), cross over probability (0.8), and mutation probability (0.04).

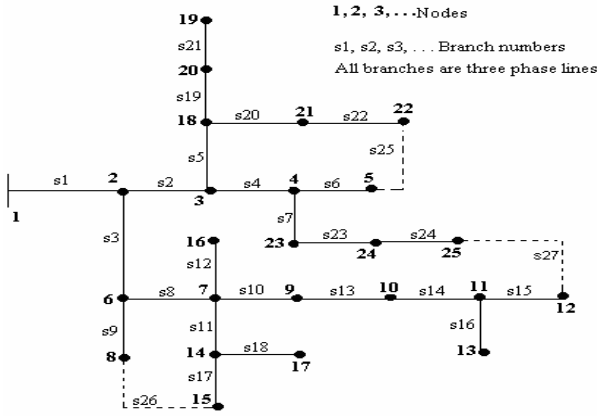

Fig. 5 Single line diagram of 25 node URDS before network reconfiguration

TABLE III
 VOLTAGE PROFILE OF 25 NODE URDS

Node No.	Before Reconfiguration			After Reconfiguration		
	$ V_a $ (p.u)	$ V_b $ (p.u)	$ V_c $ (p.u)	$ V_a $ (p.u)	$ V_b $ (p.u)	$ V_c $ (p.u)
1	1.0000	1.0000	1.0000	1.0000	1.0000	1.0000
2	0.9702	0.9711	0.9755	0.9703	0.9712	0.9755
3	0.9632	0.9644	0.9698	0.9626	0.9637	0.9693
4	0.9598	0.9613	0.9674	0.9590	0.9602	0.9668
5	0.9587	0.9603	0.9664	0.9459	0.9466	0.9531
6	0.9550	0.9559	0.9615	0.9565	0.9577	0.9629
7	0.9419	0.9428	0.9492	0.9485	0.9499	0.9551
8	0.9529	0.9538	0.9596	0.9473	0.9486	0.9545
9	0.9359	0.9367	0.9438	0.9439	0.9454	0.9509
10	0.9315	0.9319	0.9395	0.9408	0.9423	0.9479
11	0.9294	0.9296	0.9376	0.9396	0.9410	0.9468
12	0.9284	0.9284	0.9366	0.9446	0.9456	0.9541
13	0.9287	0.9287	0.9368	0.9389	0.9401	0.9460
14	0.9359	0.9370	0.9434	0.9462	0.9477	0.9525
15	0.9338	0.9349	0.9414	0.9451	0.9465	0.9526
16	0.9408	0.9418	0.9483	0.9474	0.9489	0.9542
17	0.9347	0.9360	0.9420	0.9450	0.9466	0.9512
18	0.9573	0.9586	0.9643	0.9556	0.9568	0.9628
19	0.9524	0.9544	0.9600	0.9507	0.9526	0.9585
20	0.9548	0.9563	0.9620	0.9531	0.9545	0.9605
21	0.9537	0.9549	0.9605	0.9504	0.9514	0.9575
22	0.9518	0.9525	0.9585	0.9468	0.9474	0.9538
23	0.9565	0.9584	0.9648	0.9547	0.9560	0.9632
24	0.9544	0.9565	0.9631	0.9516	0.9529	0.9606
25	0.9520	0.9547	0.9612	0.9471	0.9486	0.9566

Voltage profile and summary of test results of 25 node URDS before and after network reconfiguration are given tables 3 and 4 respectively. From tables 3 and 4, it is observed that the minimum voltage in phases A, B, C are improved from 0.9284, 0.9284 and 0.9366 to 0.9389, 0.9401 and 0.9460 and the active power loss in phases of A, B and C are reduced from 52.82, 55.44 and 41.86 kW to 47.53, 49.45 and 36.49 kW respectively. The normally opened switches s25, s26 and s27 are for before configuration and open switches s22, s17 and s15 are for after reconfiguration in the 25 node unbalanced radial distribution system. From table 4 it is

observed that the percentage reduction in active power loss after reconfiguration is 11.08%. After the reconfiguration of 25 node unbalanced radial distribution system has been shown in the Fig. 6. The total active power loss Vs generation number for 25 node URDS is shown in Fig. 7.

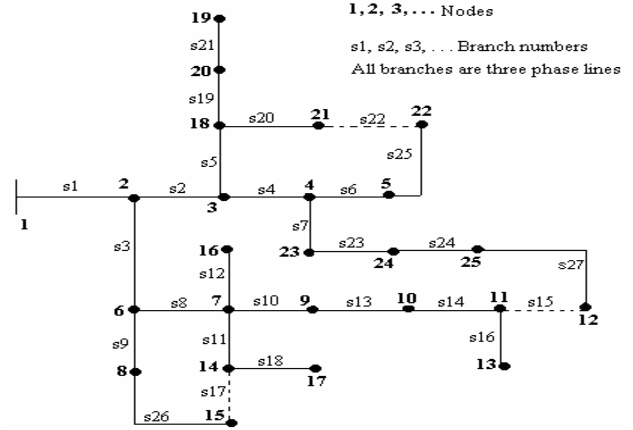

Fig. 6 Single line diagram of 25 node URDS after network reconfiguration

TABLE IV
 SUMMARY OF TEST RESULTS OF 25 NODE URDS

Description	Before Reconfiguration			After Reconfiguration		
	Phase a	Phase b	Phase c	Phase a	Phase b	Phase c
Open Switches	s25, s26, s27			s15, s17, s22		
Minimum Voltage	0.9284	0.9284	0.9366	0.9389	0.9401	0.9460
Max. Voltage regulation (%)	7.16	7.16	6.34	6.11	5.99	5.40
Improvement of Max. Voltage regulation (%)	-	-	-	14.64	16.34	14.82
Total Active Power Loss (kW)	52.82	55.44	41.86	47.53	49.45	36.49
Total Active Power Loss reduction (%)	-	-	-	10.01	9.90	12.82
Total Reactive Power Loss (kVAr)	58.32	53.29	55.69	55.20	50.19	52.22
Total Reactive Power Loss reduction (%)	-	-	-	5.34	5.81	6.23
Total Active Power Demand (kW)	1126.12	1138.74	1125.16	1120.83	1133.25	1119.79
Total Released Demand (kW)	-	-	-	5.29	5.49	5.37
Total Reactive Power Demand (kVAr)	850.32	854.29	855.69	847.20	851.19	852.52
Total Released Reactive Power Demand (kVAr)	-	-	-	3.12	3.1	3.47
Total Feeder Capacity (kVA)	1411.09	1423.57	1413.57	1404.99	1416.71	1407.38
Total Released Feeder Capacity (kVA)	-	-	-	6.1	6.86	6.19

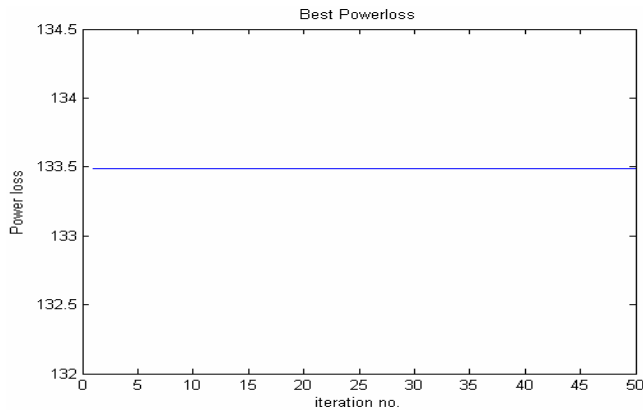

Fig. 7 Total Active Power loss Vs Generation number of 25 node URDS

TABLE V
 COMPARISON OF TEST RESULTS FOR 19 AND 25 NODE URDS WITH THE EXISTING METHODS

Methods	19 node URDS		25 node URDS	
	No of switching operation	Loss reduction (kW)	No of switching operation	Loss reduction (kW)
Shirmohammadi and Hong method [4]	6	5.19	5	16.63
Goswami and Basu method [5]	6	5.19	5	16.63
Proposed Method	6	5.21	3	16.63

Comparison of test results of the proposed method for 19 node and 25 node URDS with the existing methods are given in table 5. The proposed method has been compared with existing methods of Shirmohammadi and Hong's method [4] and Goswami and Basu's method [5] and results are presented in Table 5. From table 3.10 the effectiveness of the proposed method compared with number of switching operation and loss reduction with two existing methods. The total active power loss reduction has been improved after network reconfiguration. The number of switching operations was less for the proposed method when compared with the existing methods. Hence the proposed method is superior when compared with the existing methods.

VI. CONCLUSION

The results demonstrate the effectiveness of the proposed algorithm. In addition to power loss reduction, voltage profile is also improved by the proposed method. The objective function of this paper has been shown that genetic algorithm can be used to find the configuration of the unbalanced distribution networks which minimizes overall power losses of the distribution system. It has been found that the proposed method switching options are lesser than the existing methods. The effectiveness of proposed method has been tested on two unbalanced radial distribution systems.

APPENDIX

TABLE A1
 LOAD DATA AND LINE CONNECTIVITY OF 19 NODE UNBALANCED RADIAL DISTRIBUTION SYSTEM

branch	Sending End	Receiving End	Conductor type	Length, km	Receiving end load in kVA		
					Phase A	Phase B	Phase C
1	1	2	1	3.0	10.38 + j5.01	5.19 + j2.52	10.38 + j5.01
2	2	3	1	5.0	11.01 + j5.34	5.19 + j2.52	9.72 + j4.71
3	2	4	1	1.5	4.05 + j 1.95	5.67 + j2.76	6.48 + j3.15
4	4	5	1	1.5	6.48 + j3.15	5.19 + j2.52	4.53 + j2.19
5	4	6	1	1.0	4.20 + j2.04	3.09 + j1.50	2.91 + j1.41
6	6	7	1	2.0	9.72 + j4.71	8.10 + j3.93	8.10 + j3.93
7	6	8	1	2.5	7.44 + j3.60	5.34 + j2.58	3.39 + j1.65
8	8	9	1	3.0	12.3 + j5.97	14.91 + j7.23	13.29 + j6.42
9	9	10	1	5.0	3.39 + j1.65	4.20 + j2.04	2.58 + j1.26
10	10	11	1	1.5	7.44 + j3.60	7.44 + j3.60	11.01 + j5.34
11	10	12	1	1.5	9.72 + j4.71	8.10 + j3.93	8.10 + j3.93
12	11	13	1	5.0	4.38 + j2.13	5.34 + j2.58	6.48 + j3.15
13	11	14	1	1.0	3.09 + j1.50	3.09 + j1.50	4.05 + j1.95
14	12	15	1	5.0	4.38 + j2.13	4.86 + j2.34	6.96 + j3.36
15	12	16	1	6.0	7.77 + j3.78	10.38 + j5.01	7.77 + j3.78
16	14	17	1	3.5	6.48 + j3.15	4.86 + j2.34	4.86 + j2.34
17	14	18	1	4.0	5.34 + j2.58	5.34 + j2.58	5.52 + j2.67
18	15	19	1	4.0	8.76 + j4.23	10.05 + j4.86	7.14 + j3.45

Type	Impedance in ohms/km		
	a	b	c
1	a	1.5609 + j0.67155	0.5203 + j0.22385
	b	0.5203 + j0.22385	1.5609 + j0.67155
	c	0.5203 + j0.22385	1.5609 + j0.67155

TABLE A2
 LOAD DATA AND LINE CONNECTIVITY OF 25 NODE UNBALANCED RADIAL DISTRIBUTION SYSTEM

branch	Sending End	Receiving End	Conductor type	Length, ft	Receiving end load in kVA		
					Phase A	Phase B	Phase C
1	1	2	1	1000	0	0	0
2	2	3	1	500	35 + j25	40 + j30	45 + j32
3	2	6	2	500	40 + j30	45 + j32	35 + j25
4	3	4	1	500	50 + j40	60 + j45	50 + j35
5	3	18	2	500	40 + j30	40 + j30	40 + j30
6	4	5	2	500	40 + j30	40 + j30	40 + j30
7	4	23	2	400	60 + j45	50 + j40	50 + j35
8	6	7	2	500	0	0	0
9	6	8	2	1000	40 + j30	40 + j30	40 + j30
10	7	9	2	500	60 + j45	50 + j40	50 + j35
11	7	14	2	500	50 + j35	50 + j40	60 + j45
12	7	16	2	500	40 + j30	40 + j30	40 + j30
13	9	10	2	500	35 + j25	40 + j30	45 + j32
14	10	11	2	300	45 + j32	35 + j25	40 + j30
15	11	12	3	200	50 + j35	60 + j45	50 + j40
16	11	13	3	200	35 + j25	45 + j32	40 + j30
17	14	15	2	300	133.3 + j100	133.3 + j100	133.3 + j100
18	14	17	3	300	40 + j30	35 + j25	45 + j32
19	18	20	2	500	35 + j25	40 + j30	45 + j32
20	18	21	3	400	40 + j30	35 + j25	45 + j32
21	20	19	3	400	60 + j45	50 + j35	50 + j40
22	21	22	3	400	50 + j35	60 + j45	50 + j40
23	23	24	2	400	35 + j25	45 + j32	40 + j30
24	24	25	3	400	60 + j45	50 + j30	50 + j35

Type	Impedance in ohms/mile			
	a	b	c	
1	a	0.3686 + j0.6852	0.0169 + j0.1515	0.0155 + j0.1098
	b	0.0169 + j0.1515	0.3757 + j0.6715	0.0188 + j0.2072
	c	0.0155 + j0.1098	0.0188 + j0.2072	0.3723 + j0.6782
2	a	0.9775 + j0.8717	0.0167 + j0.1697	0.0152 + j0.1264
	b	0.0167 + j0.1697	0.9844 + j0.8654	0.0186 + j0.2275
	c	0.0152 + j0.1264	0.0186 + j0.2275	0.9810 + j0.8648
3	a	1.9280 + j1.4194	0.0161 + j0.1183	0.0161 + j0.1183
	b	0.0161 + j0.1183	1.9308 + j1.4215	0.0161 + j0.1183
	c	0.0161 + j0.1183	0.0161 + j0.1183	1.9337 + j1.4236

REFERENCES

[1] Asian Development Bank, "Power systems efficiency through loss reduction and load management," *Proceedings of the Regional Conference on Power Systems Efficiency through Loss Reduction and Load Management*, 1985.

[2] S. Civanlar, J.J. Grainger, H. Yin and S.h. Lee "Distribution feeder reconfiguration for loss reduction," *IEEE Trans. Power Deliv.* 3, (3), pp. 1217-1223,1988.

[3] M.E. Baran, and F.F. Wu "Network reconfiguration in distribution for loss reduction and load balancing," *IEEE Trans. Power Syst.*, 4, (3), pp. 1401-1407, 1989.

[4] D. Shirmohammadi and H.W. Hong "Reconfiguration of electric distribution networks for resistive line loss reduction," *IEEE Trans. Power Deliv.*, 4, (2), pp. 1492-1498,1989.

[5] S.K. Goswami and S.K. Basu " new algorithm for the reconfiguration of distribution feeders for loss minimization," *IEEE Trans. Power Deliv.*, 7, (3), pp. 1484-1491, 1992.

[6] T. Taylor and D. Lubkeman "Implementation of heuristic strategies for distribution feeder reconfiguration," *IEEE Trans. Power Deliv.*, 5, (1), pp. 239-246, 1990.

[7] V. Glaomocanin "Optimal loss reduction of distribution networks," *IEEE Trans. Power Syst.*, 5, (3), pp. 774-781, 1990.

[8] T.P. Wagner, A.Y. Chikhani and R.Hackam "Feeder reconfiguration for loss reduction," *IEEE Trans. Power Deliv.*, 6, (4), pp. 1922-1933, 1991.

[9] V. Borozan, D. Rajicic and R. Ackovski "Improved method for loss minimization in distribution networks," *IEEE Trans. Power Syst.*, 10, (3), pp. 1420-1425, 1995.

[10] R.J. Sarfi, M.M.A. Salama and A.Y. Chikhani "A survey of the state of the art in distribution system reconfiguration for system loss reduction," *Electr. Power Syst. Res.*, 31, pp. 61-70, 1994.

[11] R.J. Sarfi, M.M.A. Salama and A.Y. Chikhani "Distribution system reconfiguration for loss reduction: an algorithm based on network partitioning theory," *IEEE Trans. Power Syst.*, 11, (1), pp. 504-510, 1996.

[12] I. Roytelman, V. Melnik, S.S. H.Lee and R.L. Lugtu "Multi-objective feeder reconfiguration by distribution system management system," *IEEE Trans. Power Syst.*, 11, (2), pp. 661-667, 1996.

[13] D. Jiang and R. Baldick "Optimal electric distribution system reconfiguration and capacitor control," *IEEE Trans. Power Syst.*, 11, (2), pp. 890-897, 1996.

[14] G.J. Peponis, M.P. Papadopoulos and N.D. Hatziaargyriou "Optimal operation of distribution networks," *IEEE Trans. Power Syst.*, 11, (1), pp. 59-67, 1996.

[15] T.E. McDermott, I. Drezga and R.P. Broad Water "A heuristic non-linear constructive method for distribution system reconfiguration," *IEEE Trans. Power Syst.*, 14, (2), pp. 478-483, 1998.

- [16] C.S. Chen and M.Y. Cho "Energy loss reduction by critical switches," *IEEE Trans. Power Deliv.*, 8, (3), pp. 1246–1253, 1993.
- [17] Q. Zhou, D. Shirmohammadi and W.H.E Liu "Distribution feeder reconfiguration for operation cost reduction," *IEEE Trans. Power Syst.*, 12, (2), pp. 724–729, 1997.
- [18] H.P. Schmidt, N. Ida, N. Kagan and J.C. Guaraldo "Fast reconfiguration of distribution systems considering loss minimization," *IEEE Trans. Power Syst.*, 20, (3), pp. 1311–1319, 2005.
- [19] R. Taleski, and D. Rajcic "Distribution network reconfiguration for energy loss reduction," *IEEE Trans. Power Syst.*, 12, (1), pp. 293–406, 1997.
- [20] H.D. Chiang and R.M. Jean-Jameau "Optimal network reconfiguration in distribution systems, Part 1: a new formulation and a solution methodology," *IEEE Trans. Power Deliv.*, 5, (4), pp. 1902–1909, 1990.
- [21] H.D. Chiang and R.M. Jean-Jameau "Optimal network reconfiguration in distribution systems, Part 2: solution algorithms and numerical results," *IEEE Trans. Power Deliv.*, 5, (3), pp. 1568–1574, 1990.
- [22] H.C. Cheng and C.C. Kuo "Network reconfiguration in distribution systems using simulated annealing," *Electr. Power Syst. Res.*, 29, pp. 227–238, 1994.
- [23] Y.J. Jeon, J.C. Kim, J.O. Kim, J.R. Shin and K.Y. Lee "An efficient simulated annealing algorithm for network reconfiguration in large-scale distribution systems," *IEEE Trans. Power Deliv.*, 17, (4), pp. 1070–1078, 2002.
- [24] A.B. Morton and I.M. Mareels "An efficient brute-force solution to the network reconfiguration problem," *IEEE Trans. Power Syst.*, 15, (3), pp. 996–1000, 2000.
- [25] L. Liu and X.Y. Cheng, "Reconfiguration of Distribution networks based on fuzzy Genetic algorithms," *Proceedings of the CSEE*, , vol. 20, no. 2, pp. 66–69, February 2000.
- [26] K. Nara, A. Shiose, M. Kitagawa and T. Ishihara "Implementation of genetic algorithm for distribution system loss minimum reconfiguration," *IEEE Trans. Power Syst.*, 7, (3), pp. 1044–1051, 1992.
- [27] J.Z. Zhu "Optimal reconfiguration of electrical distribution network using the refined genetic algorithm," *Electr. Power Syst. Res.*, 62, pp. 37–42, 2002.
- [28] E. Lopez, H. Opazo, L. Garcia and P. Bastard "Online reconfiguration considering variability demand: applications to real networks," *IEEE Trans. Power Syst.*, 19, (1), pp. 549–553, 2004.
- [29] Y.Y. Hong and S.Y. Ho "Determination of network configuration considering multi-objective in distribution systems using genetic algorithms," *IEEE Trans. Power Syst.*, 20, (2), pp. 1062–1069, 2005.
- [30] J.P. Chiou, C.F. Chung and C.T. Su "Variable scaling hybrid differential evolution for solving network reconfiguration of distribution systems," *IEEE Trans. Power Syst.*, 20, (2), pp. 668–674, 2005.
- [31] J. Mendoza, R. Lopez, D. Morales, E. Lopes, P. Dessante and R. Moraga "Minimal loss reconfiguration using genetic algorithms with restricted population and addressed operators: real application", *IEEE Trans. Power Syst.*, 21, (2), pp. 948–954, 2006.
- [32] Y.T. Hsiao "Multi-objective evolution programming method for feeder reconfiguration," *IEEE Trans. Power Syst.*, 19, (1), pp. 594–599, 2004.
- [33] V. Borozan, D. Rajcic and R. Ackovski "Minimum loss reconfiguration of unbalanced distribution networks," *IEEE Trans. Power Deliv.*, 12, (1), pp. 435–442, 1997.
- [34] J.C. Wang, H.D. Chiang and G.R. Darling "An efficient algorithm for real time network reconfiguration in large scale unbalanced distribution systems," *IEEE Trans. Power Syst.*, 11, (1), pp. 511–517, 1996.
- [35] D.E. Goldberg, *Genetic Algorithms in Search, Optimization and Machine Learning*, Boston: Addison Wesley, 1989.
- [36] W.H. Kersting, *Distribution System Modeling and Analysis*, CRC press, 2002.

Ganesh Vulasala received the M. Tech. in Power System Operation and Control from S V University, Tirupati, Andhra Pradesh, India in 2003. Currently, he is a Research Scholar in Electrical Engineering Department of JNT University, Anantapur, India. He is an Assistant Professor in the Department of Electrical and Electronics Engineering, JNTU College of Engineering, Anantapur, Andhra Pradesh, India. His areas of research include Power System, Distribution Systems, Optimization Techniques, GA application to Power Distribution System.

Sivanagaraju Sirigiri received the M. Tech. in Power System from IIT, Karaghpur, West Bengal, India in 2000. He received the Ph.D. in Electrical and Electronics Engineering from JNT University, Hyderabad in 2004. He is an Associate Professor in Electrical and Electronics Engineering, JNTU College of Engineering, Kakinada. His areas of research include Power System, FACTS, Distribution Systems, Optimization Techniques, GA applications to Power Systems and FACTS.

Ramana Thiruveedula is pursuing the M. Tech. in Power and Industrial Drives from JNT University, Kakinada, Andhra Pradesh, India. He is an Assistant Professor in the Department of Electrical and Electronics Engineering, VRSYRN College of Engineering and Technology, Chirala, Andhra Pradesh, India. His areas of research include Power System, FACTS, Distribution Systems, Optimization Techniques, GA applications to Power Systems and FACTS.