

On the Analysis of IP Traffic Distribution in the Network of Suranaree University of Technology

Paramet Nualmuenwai and Chutima Prommak*

Abstract—This paper presents the IP traffic analysis. The traffic was collected from the network of Suranaree University of Technology using the software based on the Simple Network Management Protocol (SNMP). In particular, we analyze the distribution of the aggregated traffic during the hours of peak load and light load. The traffic profiles including the parameters described the traffic distributions were derived. From the statistical analysis applying three different methods, including the Kolmogorov Smirnov test, Anderson Darling test, and Chi-Squared test, we found that the IP traffic distribution is a non-normal distribution and the distributions during the peak load and the light load are different. The experimental study and analysis show high uncertainty of the IP traffic.

Keywords—IP traffic analysis, IP traffic distribution, Traffic uncertainty

I. INTRODUCTION

UNDERSTAND the IP traffic characteristics is essential to manage the network resource utilization effectively. Various applications transferred over IP networks require different levels of service quality and guarantee. The network service providers need to manage network resources available to accommodate traffic demands and compromise between the limited network capacity and the service performance. The uncertainty behavior of IP traffic brings challenges to the IP network provisioning and management.

Several works in literature have paid attention on the study of the IP traffic characteristics. In [1], the authors present the implementation of the network traffic supervision system by using the method that analyzing traffic feature parameters distribution. In [2], the internet traffic model with a linear-time generation algorithm was proposed. The generated traffic trace is long-range dependent and its rates are distributed with a shifted gamma distribution. In [3], the authors present the internet aggregate traffic analysis at the flow level, in both spatial and temporal dimensions. In [4], a close relationship among network traffic, network user and network application in the complex network environment were studied and analyzed. The authors proposed a new network traffic model based on the use of Gini coefficient. The proposed model takes into consideration the network traffic profiles, user behaviors

This work was supported in part by Suranaree University of Technology, the Office of the Higher Education Commission under NRU project of Thailand and the National Research Council of Thailand (NRCT).

P. Nualmuenwai and C. Prommak*, are with the School of Telecommunication Engineering, Suranaree University of Technology, Nakhon Ratchasima, 30000 Thailand (phone: 66-44-224393; fax: 66-44-224603; e-mail: cprommak@sut.ac.th). *corresponding author

and the network applications. In [5], the authors report the growth of the internet traffic and bandwidth availability of three major Internet service providers in Thailand.

Most existing works in literature focused on the study of traffic applications and interested in management and analysis of traffic network. While the results and finding reveal crucial characteristics, the literature lacks of the study on the aggregate traffic behaviors. Therefore, this paper presents the study of the temporal characteristics of the aggregated traffic that was collected from the network of Suranaree University of Technology using the software based on the Simple Network Management Protocol (SNMP). In particular, we analyze the distribution of the aggregated traffic during the hours of peak load and light load and derive the traffic profiles including the parameters described the traffic distributions.

The rest of this paper is structured as follows. Section II presents the network structure and the experiment setup. Section III presents the IP traffic characteristic and the distribution analysis. The parameters of the distribution are derived. Finally, we conclude the paper in section IV.

II. NETWORK STRUCTURE AND EXPERIMENT DESIGN

Network for the distribution feature analysis in this study is network within Suranaree University of Technology. This is internal network connected to external networks, which the network spend Firewall between internal network and external network to network security. Firewall is protected safety for network by the traffic connect to multilayer switch of internal network through optic cable size 10 Gbps and then distribute to switch of building through optic cable size 10 Gbps and forward to subswitch of the agency or organization through optic cable size 1 Gbps and distribute to Access Point, which Access Point is wireless local area network (WLAN) that connect through Unshielded Twisted Pair cable (UTP) size 1 Gbps. We select feature analysis of traffic internet of dormitories within campus. As shown in Figure 1, which network of dormitories within campus use volume of traffic as 80 percent of all volume of traffic.

For analysis of traffic feature, we are operation using monitor traffic program for traffic detection to save data of traffic. The monitor traffic program will run in the application layer of OpeSystem Interconnection Reference Model (OSI), which protocol is Simple Network Management Protocol (SNMP). But, some programs might use other protocols to help for monitor traffic. In this research, we operate using PRTG Traffic Grapher Program [8] to save data of traffic.

We operate to save data of traffic in one month by collection data on both main switch and subswitch. we are show example of main switch (Switch S4) in Fig. 2 and subswitch (Switch S13) in Fig. 3, which both shows an example usage around traffic within 7 days (1 week) by this is saved to every 1 minute. We observe that more volume of traffic on main switch than volume of traffic on subswitch explicitly. In Fig. 4 shows the comparison of traffic in each day of each week, by show an example on Thursday which is working day and Sunday which is a holiday. Both show that

volume of traffic for each day of each week is used in the same way, which working day will be running volume of traffic rather than the holiday. For analysis of traffic feature, we have analyzed symmetric and outlier and then consider histogram of data. We operate using EasyFit program [9] to analyze the distribution of traffic in Peak-load hour and Light-load hour with Kolmogorov Smirnov test, Anderson Darling test and Chi-Squared test. The results of these analysis show that distribution feature and we check the accuracy of the distribution feature of traffic with P-P Plot.

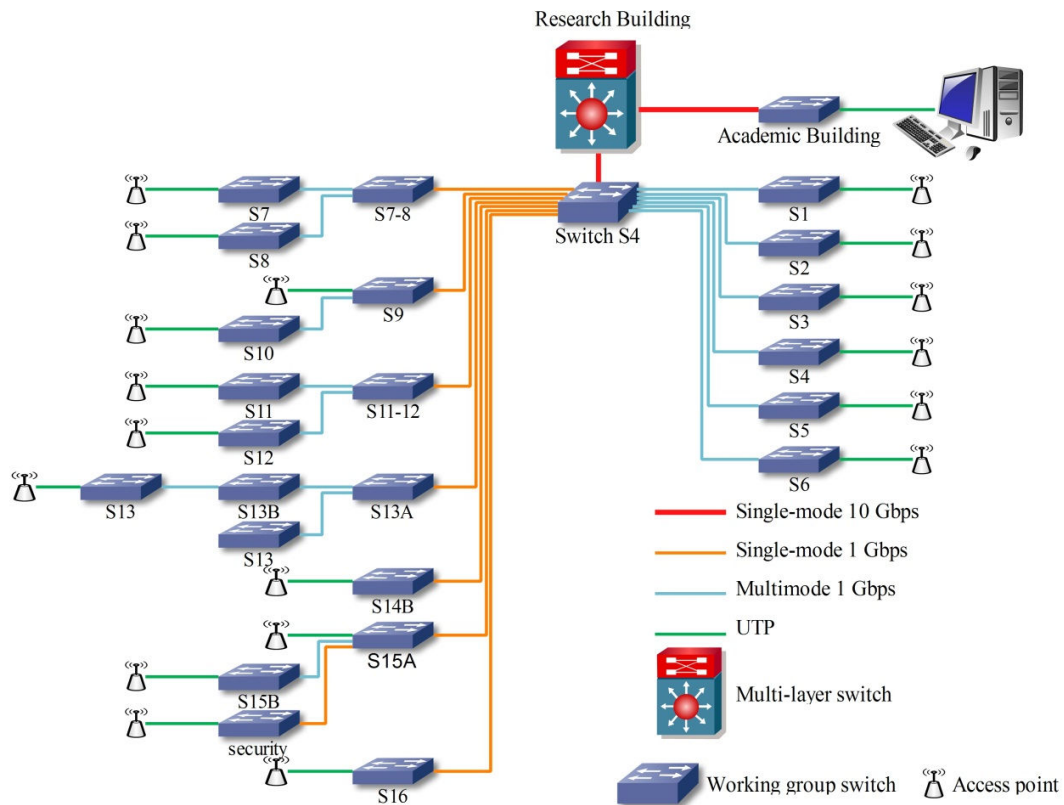

Fig. 1 Structure of the network in Suranaree University of Technology

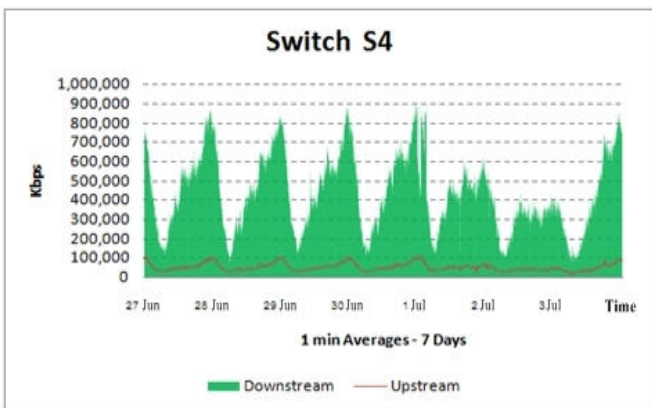

Fig. 2 Traffic volume at Switch S4

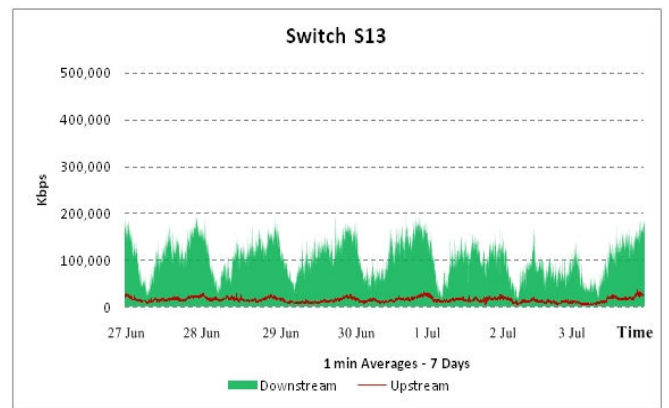
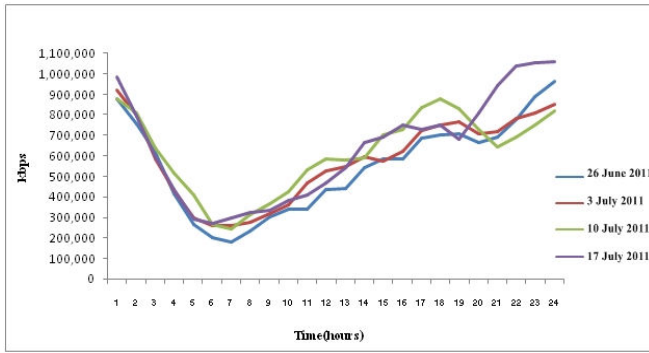
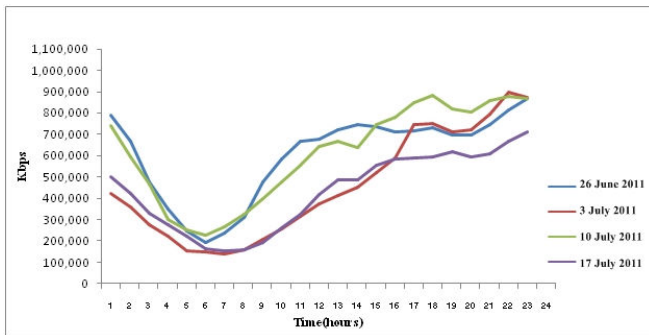

Fig. 3 Traffic volume at Switch S13



(a) Thursday



(b) Sunday

Fig. 4 Comparison of traffic at Switch S4

III. ANALYSIS DISTRIBUTION FEATURE OF TRAFFIC

We obtained data of traffic from monitor traffic program. We analyze of traffic feature during peak-load hour and Light-load hour. First, the traffic data is outlier analysis, and select devoid outlier data. We obtained data set into histogram to symmetric analysis. In Fig. 5-6 show the histogram of Switch S4 (main switch) for Peak-load hour and Light-load hour respectively. In Fig. 7-8 show the histogram of Switch S13 (subswitch) for Peak-load hour and Light-load hour respectively. We found that distribution feature of data for histogram in the Peak-load is left skewed and distribution feature of data in the Light-load is right skewed which represent is asymmetric, this means that traffic data feature is non-normal distribution.

Due to traffic data is non-normal distribution. Thus, we analyze traffic data using EasyFit program to rank distribution with Goodness of fit tests by Kolmogorov Smirnov Test, Anderson Darling Test and Chi-Squared Test, which we obtained the distribution feature [6] as shown in table I. Switch S4 in Peak-load hour is Beta distribution, Switch S4 in Light-load hour is Johnson SB Distribution, Switch S13 in Peak-load hour is Gen. Extreme Value Distribution and Switch S13 in Light-load hour is Johnson SB Distribution, by we show parameter value for the distribution feature [6] of traffic data in table I.

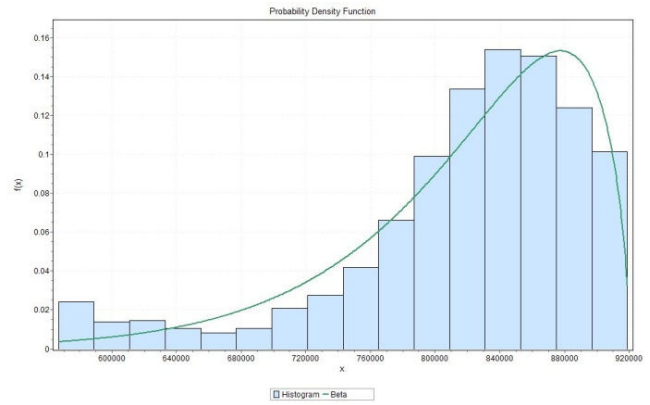

Fig. 5 Histogram of traffic during peak-load hours at Switch S4

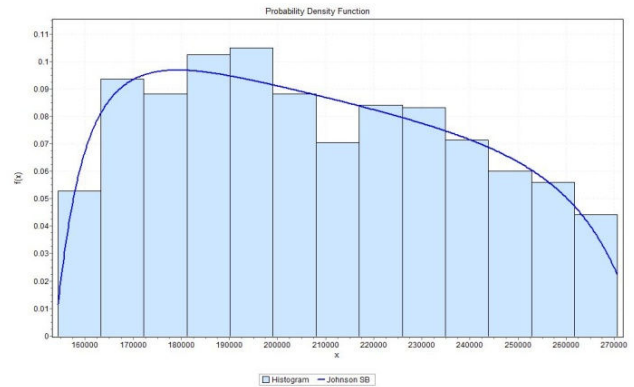

Fig. 6 Histogram of traffic during light-load hours at Switch S4

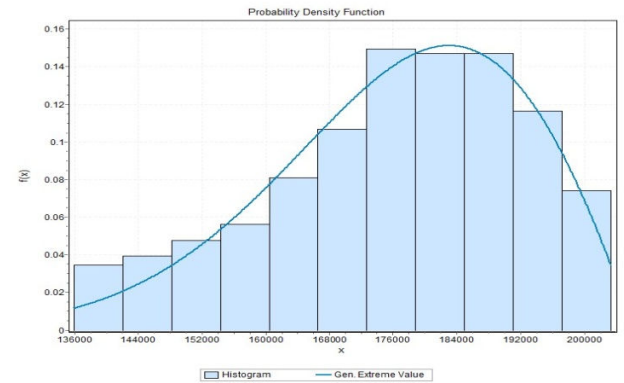

Fig. 7 Histogram of traffic during peak-load hours at Switch S13

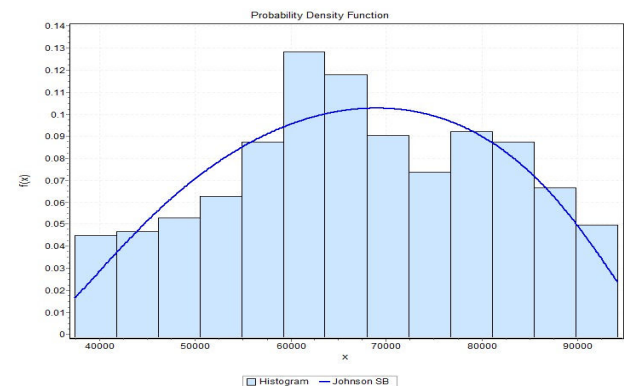

Fig. 8 Histogram of traffic during light-load hours at Switch S13

We analyzed distribution feature of traffic using Goodness of fit tests with Kolmogorov Smirnov Test, Anderson Darling Test and Chi-Squared Test which we obtained distribution feature of traffic, and then we check the accuracy of the distribution with P-P Plot analysis, as shown in Fig. 9-10 which each figure represents that probability of data traffic for the distribution feature is similar to probability of theory for the distribution features. This means that traffic is the distribution feature according to distribution features of traffic that obtained from Goodness of fit tests.

TABLE I
DISTRIBUTION PARAMETERS

Switch	Distribution	Parameters
S4 peak-load	Beta	$a_1 = 36.612$ $a_2 = 1.6628$ $a = -1.4285 \times 10^6$ $b = 9.2046 \times 10^5$
S4 light-load	Johnson SB	$\gamma = 0.21722$ $\delta = 0.74927$ $\lambda = 1.2320 \times 10^5$ $\xi = 1.5313 \times 10^5$
S13 peak-load	Gen. Extreme Value	$k = -0.52069$ $\sigma = 17618.0$ $\mu = 1.7224 \times 10^5$
S13 light-load	Johnson SB	$\gamma = -0.1054$ $\delta = 1.0219$ $\lambda = 69493.0$ $\xi = 30793.0$

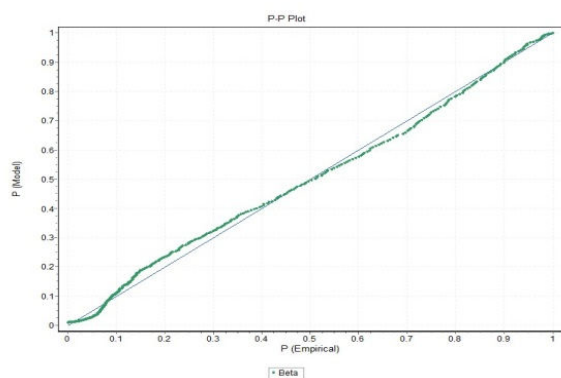

Fig. 9 P-P Plot of the peak-load hour at Switch S4

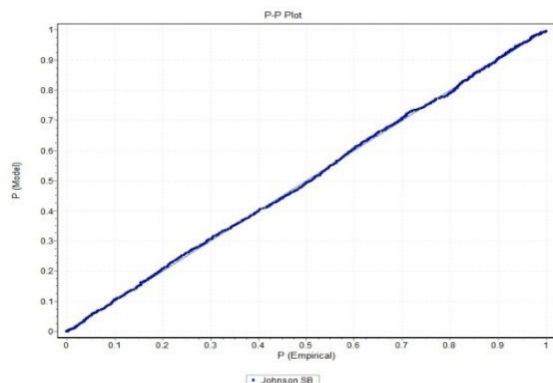

Fig. 10 P-P Plot of the light-load hour at Switch S4

IV. CONCLUSION

In this paper, we analyzed the distribution feature of traffic with Monitor Traffic for Internet Traffic of dormitories within Suranaree University of Technology. Furthermore, we consider used in the Peak-load hour and Light-load hour by analysis the distribution feature of traffic with histogram that represents the data that is non-normal distribution. Therefore, we analyzed of feature of traffic using Goodness of fit tests with Kolmogorov Smirnov Test, Anderson Darling Test and Chi-Squared Test, and check the accuracy of the distribution feature of traffic with P-P Plot to indicate the traffic distribution feature of property.

REFERENCES

- [1] X. Du, Y. Yang and X. Kang, "A Network Traffic Supervision System Based on Feature Parameters Distribution," in *Proc. 3rd Int. Conf. Innovative Computing Information and Control*, 2008, pp. 377-381.
- [2] S. Kim, J. Y. Lee, and D. K. Sung, "A Shifted Gamma Distribution Model for Long-Range Dependent Internet Traffic," *IEEE Communications Letters*, Vol. 7, No. 3, Mar. 2003, pp. 124-126.
- [3] L. Rodrigues and P. R. Guardieiro "A Spatial and Temporal Analysis of Internet Aggregate Traffic at the Flow Level," in *2004 Proc. IEEE Int. Conf. Communications Society Globecom*, pp. 685-691.
- [4] P. Liu, F. Liu and Z. Lei, "Model of Network Traffic based on Network Applications and Network Users," in *2008 Proc. IEEE Int. Symposium Conf. Computer Science and Computational Technology*, pp. 171-174.
- [5] P. Rungroj and C. Charnsripinyo, "Measuring Traffic on the Network to the Internet in Thailand," in *2007 NSTDA Annual Conf.*, pp. 926-931.
- [6] R. Jain, "The Art of Computer Systems Performance Analysis," New York: John Wiley & Sons, 1991, ch. 29.
- [7] Net-SNMP (2011, May 26). [Online]. Available: <http://www.net-snmp.org/>
- [8] Paessler AG The Network Monitoring Company 1998-2011. [Online]. Available: <http://www.paessler.com/prtg/>
- [9] MathWave Technologies 2004-2011. [Online]. Available: <http://www.mathwave.com/>

Chutima Prommak received her Ph.D. and M.S. degree in Telecommunications from the University of Pittsburgh in 2005 and from the University of Colorado at Boulder in 1998, respectively and received her B.S. from the University of Khon Kaen in 1992. She is now an assistant professor at the School of Telecommunication Engineering, Suranaree University of Technology, Thailand. Her research interests include wireless network design, optical network design, network optimization and heuristic approaches for network design.

Paramet Nualmuenwai received him B.S. degree in Telecommunication Engineering from Suranaree University of Technology, Thailand in 2010. Currently he is pursuing him M.S. degree in the school of Telecommunication Engineering, Suranaree University of Technology. He is a member at the Wireless Communication Research Lab at Suranaree University of Technology.