

The Comprehensive Study Based on Ultrasonic and X-ray Visual Technology for GIS Equipment Detection

Wei Zhang, Hong Yu, Xian-ping Zhao, Da-da Wang, Fei Xue

Abstract—For lack of the visualization of the ultrasonic detection method of partial discharge (PD), the ultrasonic detection technology combined with the X-ray visual detection method (UXV) is proposed. The method can conduct qualitative analysis accurately and conduct reliable positioning diagnosis to the internal insulation defects of GIS, and while it could make up the blindness of the X-ray visual detection method and improve the detection rate. In this paper, an experimental model of GIS is used as the trial platform, a variety of insulation defects are set inside the GIS cavity. With the proposed method, the ultrasonic method is used to conduct the preliminary detection, and then the X-ray visual detection is used to locate and diagnose precisely. Therefore, the proposed UXV technology is feasible and practical.

Keywords—GIS, ultrasonic, visual detection, X-ray

I. INTRODUCTION

AT present, the GIS equipment is used widely in the power system. It is important that the PD detection ensures the normal operation of GIS. PD signals contain plenty of insulation status information. They can not only reflect defects in the manufacture and the installation, but also detect the failure occurrence and severity. An alarm can be given in the early stage of the accident, in order to arrange the scheduled maintenance, to reduce the damage to the equipment, and to avoid the great loss caused by the accident [1].

Currently, the ultrasonic detection of PD in GIS has been widely used. This method can effectively detect the PD signals inside the device. According to the signal characteristics, the basic type of defects can be determined. Using multiple ultrasonic probes, the initial positioning of insulation defects can be achieved.

Wei Zhang is with North China Electric Power University, China (e-mail:zhangwei3211@163.com)

However, the detection method has a certain uncertainty. A new visual technique (X-ray detection technology) comes into being. After X-ray irradiation, the internal structure of the GIS cavity can be observed clearly from the X-ray photo. The method makes up the uncertainty of the ultrasonic diagnosis [2]-[4]. In this paper, several common types of PD models are designed inside GIS equipment. Firstly, the ultrasonic signal is used to determine preliminarily, and then X-ray is utilized to irradiate the GIS equipment. The accurate judgment and the precise location are got ultimately.

II. PD AND DETECTION METHODS

When the insulation exists the defects inside the device, under the long-term effect of high voltage, PD develops constantly. PD is an important signal of the insulation deterioration. It also can promote the further deterioration of insulation materials. Then the electrical insulation performance is degraded. The insulation breakdown occurs and the accident happens. The PD influence is multifaceted, such as physical, chemical, electrical and so on. With the development of PD, there are lots of sound, light, electricity, heat and other signals [5]. These different characteristics of signals correspond to the different detection methods. The ultrasound will be issued when PD occurs inside GIS. Ultrasonic signal only propagates longitudinal wave inside the cavity. Outside the cavity, it spreads either transversal wave or propagation wave. The PD point inside GIS can be seen as a point source to spread signals around. The ultrasonic wavelength is shorter, so it has strong directionality. Thus its energy is very concentrated. The ultrasonic signal can be received through the ultrasonic probes which are attached to the outer surface of the cavity. The signals are transmitted to the computer and then are analyzed [6], [7]. X-ray visual

detection technology has been effectively applied in the medical, aerospace and other fields. It is used as an aid to detect insulation defects inside GIS, to achieve the location and identification of structural insulation defects. This method provides an effective and reliable detection means for PD monitoring and pattern recognition. It is a fast and accurate method of defect identification and location for internal insulation defects in GIS, and provides the favorable basis for the field application in the insulation experiment in GIS [8].

III. THE PROPOSED METHOD OF THE UXV

In this paper, the UXV method is proposed, which uses the ultrasonic technology and the X-ray visual detection technology successively. The ultrasonic detection method realizes the initial diagnosis and the preliminary location. X-ray visual detection achieves the final structural defect location. In the laboratory, the experimental flow chart of the UXV is shown in the Fig. 1.

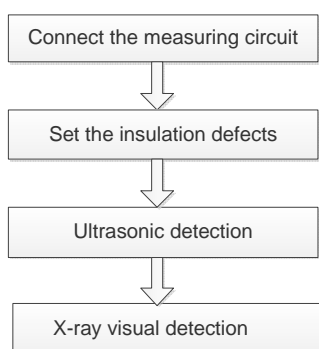

Fig. 1 The experimental flow chart of the UXV

From the experimental flow chart of the UXV in the Fig. 1, first, the measuring circuit is arranged for the experiment. Then, the insulation defect is set inside the GIS cavity. The ultrasonic method is used to detect preliminarily. If the PD signal is detected, X-ray is used to irradiate the GIS, It is to determine whether there is the insulation defect. The PD detection in GIS cannot depart from the actual operation. If it uses simply coaxial cavity as experimental object, the experimental results will be quite different from the actual situation. So the experiment uses 252kVZF11-252 (L)-type test model which is designed and manufactured specially. Fig. 2 and Fig. 3 show the physical photo and the structure diagram of the experimental model respectively.



Fig. 2 The physical photo

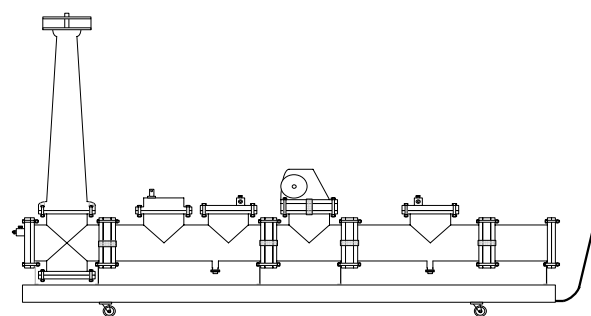

Fig. 3 The structure diagram

The circuit diagram of the experimental system is shown in Fig. 4. The power is output from the self-dual regulator. In order to avoid the interference of the external PD signals, the transformer used in the experiment is the experimental transformer without the corona which is made by WMB. The high-voltage wire uses the soft aluminum tube whose diameter is 100mm, and which ensures maximally a "clean" experimental background. The circuit connects in series with a protection resistor to avoid the damage to the detection resistance and the experimental system after the breakdown. The experimental system ensures a good ground. The ultrasonic sensors are furnished outside the GIS chamber to detect the ultrasonic signal, as shown in Fig. 5 (a) below. The ultrasonic signal is transferred to the data acquisition unit, and then is transmitted to the computer for data analysis and processing.

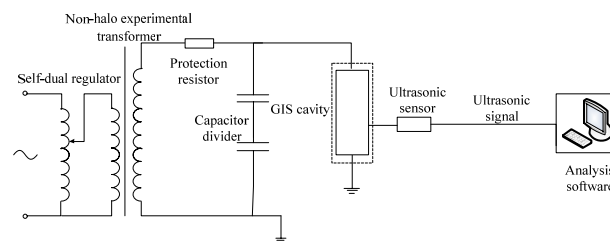

Fig. 4 Schematic diagram of the measuring system

X-ray visual detection system is composed of the X-ray

machine, the imaging plate, the computer workstation and other components. During the detection process, the X-ray machine is placed at a certain distance in front of the GIS model, and the imaging plate is close to the GIS cavity and is behind it. The head of the X-ray machine is at the same horizontal line with the center of the imaging plate, and the imaging plate is connected to the computer workstation through the software to receive, display, store and process the data. The site layout photos of the X-ray machine and the imaging plate are shown in Fig. 5 (b).



(a) Site layout of the ultrasonic detection equipment

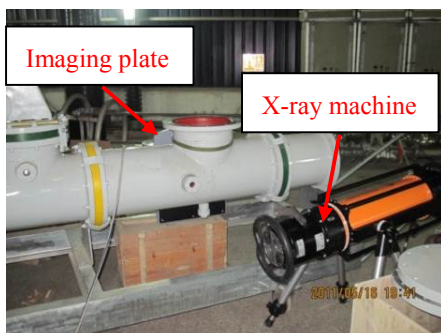

(b) Site layout of the X-ray detection equipment

Fig. 5 The site layout photos of the detection equipment

IV. INSULATION DEFECT MODELS

The GIS running experience shows that the insulation failures often happen and the majority of the accidents are caused by the insulation faults. In the process of production, transportation and site assembly, it exits inevitably insulation defects which ultimately affect the reliability of the operation. Such defects include mainly the electrode surface protrusion, free conductive particles, insulator surface particles, and internal defects of solid insulation (such as bubbles), etc. They lead to PD under the electric field. They could eventually cause the insulation damage. This paper selects the metal

protrusion and the metal suspension as the insulation defect models which are usually caused by poor processing, mechanical damage or scratches when assembling. The high field strength area is created around the metal protrusion, and PD occurs consequently. During the experiment, a section of copper wire is wrapped around the high-voltage conductive pole in the bus segment chamber to simulate this defect type. It is shown in Fig. 6 (a). The length of the tip is 40 mm and the diameter is equivalent to 300 μ m. The second defect model is shown in Fig. 6 (b). A metal tip is set inside the GIS chamber wall. The material is iron wire whose equivalent diameter is 100 μ m and whose cutting-edge length is 30mm. The third model is shown in Fig. 6 (c). A piece of aluminum block is hung in the high-voltage conductive pole by the insulation rope. The distance is 20mm between the aluminum block and the high-voltage conductive pole.



(a) Tip on the high-voltage conductive pole



(b) Tip on the ground electrode



(c) Floating potential

Fig. 6 The physical layout photos of teh simulated insulation defects

V. EXPERIMENTAL RESULTS AND ANALYSIS

According to those three discharge models above, the experiment uses the ultrasonic and the X-ray digital imaging technologies for detection. The ultrasonic method uses AIA ultrasonic detector which is produced by Norwegian. The ultrasonic signal is sent to the signal display unit through the cable for data display and processing. The frequency range of the ultrasonic sensor is 10-100 kHz, and the front-end gain is 40dB. And further, the X-ray visual detection method identifies and locates the defect type accurately. The X-ray machine and the imaging plate are produced by the GE Company.

When the discharge occurs near the conductor, the PD source can form a point source to launch spherical wave in all directions. The high-frequency part transmits directly along the cavity, while the low-frequency part transmits to the multiple angles, and the path is far away. When the acoustic wave is propagated along the cavity, the reflection and refraction occurs.

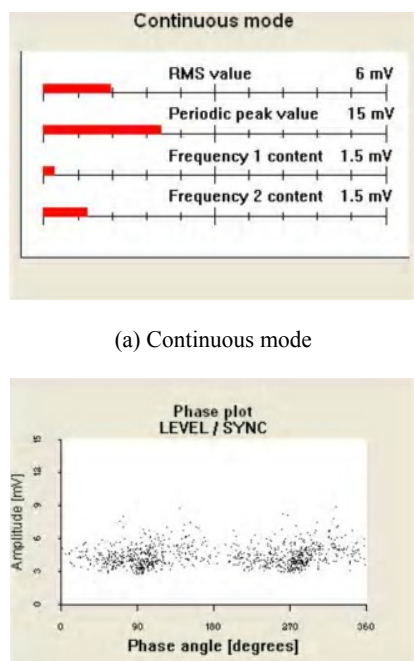

Fig. 7 AIA ultrasonic detection spectrums

Under the applied voltage amplitude of 101kV, the continuous mode and the phase pattern are shown in Fig. 7. The ultrasonic detection spectrums can be seen: (a) By the continuous mode, 100Hz correlation is greater than 50Hz

correlation; (b) From the phase mode, the discharge pulse focuses near the peak value of the voltage.

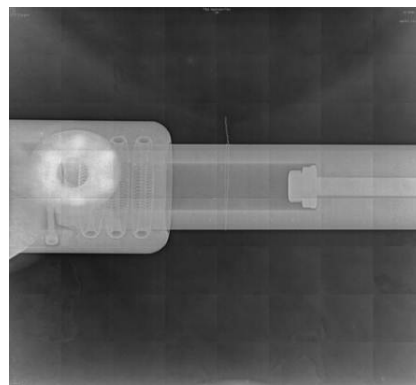

Fig. 8 X-ray photo of the tip set on the high-voltage conductive pole

Fig. 8 shows that the X-ray photo of a tip which is placed on the high-voltage conductive pole inside the bus segment chamber. The photo works well, and you can clearly see the tip from the photo. A tip is set inside the GIS cavity wall. When the voltage is applied to a certain value, PD occurs.

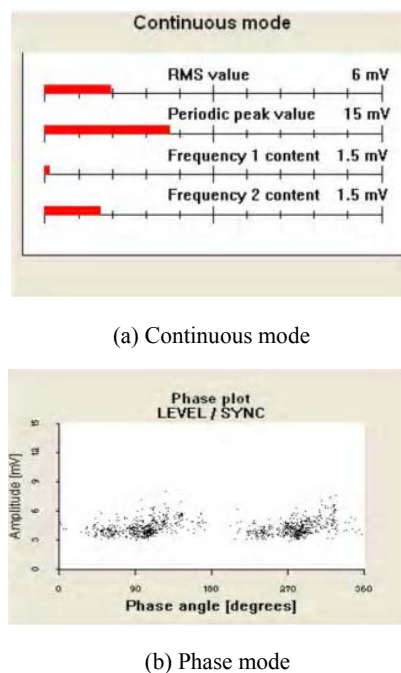

Fig. 9 AIA ultrasonic detection spectrums

From the ultrasonic detection spectrums in Fig. 9 of view, 100Hz correlation is greater than 50Hz correlation. The size of the discharge amount and the distribution shape of the discharge are still similar to the spectrums in Fig. 7, and the phase has some drift with the change of the applied voltage value.

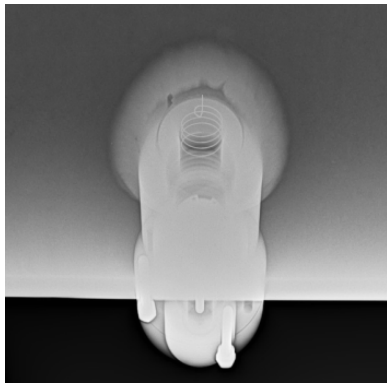
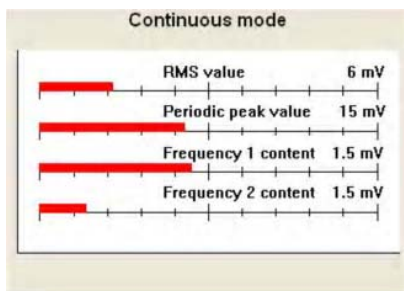

Fig. 10 X-ray photo of the tip set inside the GIS chamber wall

Fig. 10 gives the X-ray photo. The metal wire is fixed on the gas hole on the bottom of the GIS chamber, which can be clearly seen from the X-ray photo. It is clear that the X-ray visual technology is valid to the defect type.

The discharge of the floating potential near the high-voltage conductive pole is simulated by applying different voltages.



(a) Continuous mode

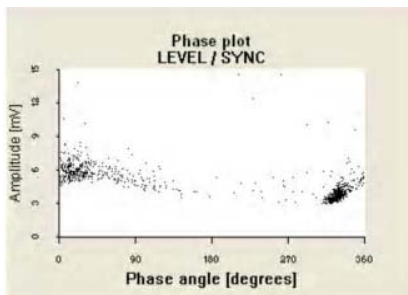

(b) Phase mode

Fig. 11 AIA ultrasonic detection spectrums

From the ultrasonic phase spectrums in Fig. 11(b), it can be clearly seen that the pulses mainly concentrate around $0^\circ \sim 45^\circ$ and $315^\circ \sim 360^\circ$. The continuous mode and the phase mode are shown in Fig. 11.



Fig. 12 The X-ray photo of a metal aluminum block on the high-voltage conductive pole inside the bus segment

Fig. 12 shows an aluminum block hung on the high-voltage conductive pole inside the bus segment. After the X-ray irradiation, the aluminum block can be clearly observed from the X-ray photo. Therefore, the X-ray visual detection technique is also effective to the insulation defect.

VI. CONCLUSION

The X-ray visual detection technology can observe the insulation situation inside the GIS cavity. For the tip on the high-voltage conductive pole, the tip on the ground electrode, the floating potential, and other types of insulation defects, the X-ray detection technology can be observed directly by the human eye from the X-ray photo. However, for the traditional detection methods, such as the pulse current method, the ultrasonic method, and the ultra-high frequency method, the insulation condition can be judged through PD signals inside the GIS, and the PD source can be located initially with the help of the technical staffs' experiences. Therefore, the UXV is proposed in this paper, which is an effective and perfect PD detection technology. It improves the accuracy of the PD location. So it could be extended to the field application.

REFERENCES

- [1] LI Da-jian, LIANG Ji-zhong, BU Ke-wei, YANG Jing-gang, LI Yan-ming. Ultrasonic Detection of Partial Discharge on Typical Defects in GIS. High Voltage Apparatus, Vol.45, No.1, Feb. 2009: 72-74
- [2] Yang Yuan, Li Cheng-rong. Study on Ultrasonic Characteristics of Typical Partial Discharge of GIS. Modern Electric Power. Vol. 26, No.5, Oct. 2009: 18-23

- [3] YAN Bin, HE Xi-mei, WANG Zhi-hui, LI Sheng-ping. Application of X-ray Digital Imaging Defect Detection System in GIS Equipment. High Voltage Apparatus, Vol.46, No.11, Nov. 2010: 89-91
- [4] S. Rizzeto, N. Fujimoto and G. C. Stone. A System for the Detection and Location of Partial Discharge Using X-Rays. Conference Record of the 1988 IEEE International Symposium on Electrical Insulation, Boston, MA, June 5-8, 1988, pp: 262-266
- [5] CHEN Min, Koji Urano, LI You-Cheng, and Atsuhide Jinno. Application of Combined PD Sensor for GIS PD Detection and Condition Monitoring. 2008 International Conference on Condition Monitoring and Diagnosis, Beijing, China, April 21-24, 2008
- [6] FANG Qing, LIU Wei-Dong, DENG Wei, TANG Xin. A new Ultrasonic Diagnosis Technology for Internal Default of GIS Equipment. High Voltage Apparatus. Vol.44, No.6, Dec. 2008: 589-595
- [7] K. Raja and T. Floribert. Comparative Investigations on UHF and Acoustic PD Detection Sensitivity in Transformers. Conference Record of the 2002 IEEE International Symposium on Electrical Insulation, MA USA, April 7-10 2002, pp: 150-153
- [8] YAN Bin, HE Xi-mei, WU Tong-sheng, WANG Zhi-hui, LI Sheng-ping. X-ray visualization detection technology for GIS equipment. Electric Power. Vol. 43, No. 7, Jul. 2010: 44-47