

# Computer Simulations of an Augmented Automatic Choosing Control Using Automatic Choosing Functions of Gradient Optimization Type

Toshinori Nawata

**Abstract**—In this paper we consider a nonlinear feedback control called augmented automatic choosing control (AACC) using the automatic choosing functions of gradient optimization type for nonlinear systems. Constant terms which arise from sectionwise linearization of a given nonlinear system are treated as coefficients of a stable zero dynamics. Parameters included in the control are suboptimally selected by minimizing the Hamiltonian with the aid of the genetic algorithm. This approach is applied to a field excitation control problem of power system to demonstrate the splendidness of the AACC. Simulation results show that the new controller can improve performance remarkably well.

**Index Terms**—augmented automatic choosing control, nonlinear control, genetic algorithm, zero dynamics.

## I. INTRODUCTION

GENERALLY, it is easy to design the optimal control laws for linear systems, but it is not so for nonlinear systems, though they have been studied for many years[1]~[8]. One of most popular and practical nonlinear control laws is synthesized by applying a linearization method by Taylor expansion truncated at the first order and the linear optimal control method. This is only effective in a small region around steady state points or in almost linear systems[1]~[3].

Another nonlinear control called an automatic choosing control (ACC) has been studied [6]. This controller is effective in nonlinear systems with high nonlinearity and wider regions. But constant terms, which generally appear in equations when linearized by Taylor expansion, lead the controller to have bias at the origin, so the resulting ACC must be modified by bothersome unbiased nonlinear functions in view of stability.

To overcome these weakness, in this paper we consider an augmented automatic choosing control (AACC) for nonlinear systems[7][8] and its design procedure is as follows.

Assume that a system is given by a nonlinear differential equation. Choose a separative variable, which makes up nonlinearity of the given system. The domain of the variable is divided into some subdomains. On each subdomain, the system equation is linearized by Taylor expansion around a suitable point so that a constant term is included in it. This constant term is treated as a coefficient of a stable zero dynamics. The given nonlinear system approximately makes up a set of augmented linear systems, to which the optimal linear control theory is applied to get the linear quadratic

(LQ) controls[2]. These LQ controls are smoothly united by automatic choosing functions of gradient optimization type to synthesize a single nonlinear feedback controller.

This controller is of a structure-specified type which has some parameters, such as the number of division of the domain, regions of the subdomains, points of Taylor expansion, and gradients of the automatic choosing function. These parameters must be selected optimally so as to be just the controller's fit. Since they lead to a nonlinear optimization problem, we are able to solve it by using the genetic algorithm (GA)[9] suboptimally. In this paper the suboptimal values of these parameters are selected by minimizing the Hamiltonian.

This approach is applied to a field excitation control problem of power system, which is Ozeki-Power-Plant of Kyushu Electric Power Company in Japan, to demonstrate the splendidness of the AACC. Simulation results show that the new controller using the GA is able to improve performance remarkably well.

## II. AUGMENTED AUTOMATIC CHOOSING CONTROL USING ZERO DYNAMICS

Assume that a nonlinear system is given by

$$\dot{x} = f(x) + g(x)u, \quad x \in \mathbf{D} \quad (1)$$

where  $\dot{\cdot} = d/dt$ ,  $x = [x[1], \dots, x[n]]^T$  is an  $n$ -dimensional state vector,  $u = [u[1], \dots, u[r]]^T$  is an  $r$ -dimensional control vector,  $f: \mathbf{D} \rightarrow R^n$  is a nonlinear vector-valued function with  $f(0) = 0$  and is continuously differentiable,  $g(x)$  is an  $n \times r$  driving matrix with  $g(0) \neq 0$ ,  $\mathbf{D} \subset R^n$  is a domain, and  $T$  denotes transpose.

Considering the nonlinearity of  $f$ , introduce a vector-valued function  $C: \mathbf{D} \rightarrow R^L$  which defines the separative variables  $\{C_j(x)\}$ , where  $C = [C_1 \dots C_j \dots C_L]^T$  is continuously differentiable. Let  $D$  be a domain of  $C^{-1}$ . For example, if  $x[2]$  is the element which has the highest nonlinearity in  $f$ , then

$$C(x) = x[2] \in D \subset R \quad (L = 1)$$

(see Section IV). The domain  $D$  is divided into some subdomains:  $D = \cup_{i=0}^M D_i$ , where  $D_M = D - \cup_{i=0}^{M-1} D_i$  and  $C^{-1}(D_0) \ni 0$ .  $D_i (0 \leq i \leq M)$  endowed with a lexicographic order is the Cartesian product  $D_i = \prod_{j=1}^L [a_{ij}, b_{ij}]$ , where  $a_{ij} < b_{ij}$ .

Introduce a stable zero dynamics :

$$\dot{x}[n+1] = -\sigma_i x[n+1] \quad (2)$$

T. Nawata is with the Department of Human-Oriented Information Systems Engineering, Kumamoto National College of Technology, Koshi, Kumamoto, 861-1102 JAPAN e-mail: nawata@kumamoto-nct.ac.jp .

$$(x[n+1](0) \simeq 1, \quad 0 < \sigma_i < 1).$$

Eq.(1) combines with (2) to form an augmented system

$$\dot{\mathbf{X}} = \bar{f}(\mathbf{X}) + \bar{g}(\mathbf{X})u \quad (3)$$

where

$$\mathbf{X} = \begin{bmatrix} x \\ x[n+1] \end{bmatrix} \in \mathbf{D} \times R$$

$$\bar{f}(\mathbf{X}) = \begin{bmatrix} f(x) \\ -\sigma_i x[n+1] \end{bmatrix}, \bar{g}(\mathbf{X}) = \begin{bmatrix} g(x) \\ 0 \end{bmatrix}.$$

We assume a cost function being

$$J = \frac{1}{2} \int_0^\infty (\mathbf{X}^T \mathbf{Q} \mathbf{X} + u^T R u) dt \quad (4)$$

where  $\mathbf{Q} = \mathbf{Q}^T > 0$ ,  $R = R^T > 0$ , and the values of these matrices are properly determined based on engineering experience.

On each  $D_i$ , the nonlinear system is linearized by the Taylor expansion truncated at the first order about a point  $\hat{X}_i \in C^{-1}(D_i)$  and  $\hat{X}_0 = 0$  (see Fig. 1):

$$f(x) + g(x)u \simeq A_i x + w_i + B_i u \quad \text{on } C^{-1}(D_i) \quad (5)$$

where

$$A_i = \left. \frac{\partial f(x)}{\partial x^T} \right|_{x=\hat{X}_i}, \quad w_i = f(\hat{X}_i) - A_i \hat{X}_i, \\ B_i = g(\hat{X}_i).$$

Make an approximation of (3) by

$$\dot{\mathbf{X}} = \bar{A}_i \mathbf{X} + \bar{B}_i u \quad \text{on } C^{-1}(D_i) \times R \quad (6)$$

where

$$\bar{A}_i = \begin{bmatrix} A_i & w_i \\ 0 & -\sigma_i \end{bmatrix}, \bar{B}_i = \begin{bmatrix} B_i \\ 0 \end{bmatrix}.$$

An application of the linear optimal control theory [2] to (4) and (6) yields

$$u_i(\mathbf{X}) = -R^{-1} \bar{B}_i^T \mathbf{P}_i \mathbf{X} \quad (7)$$

where the  $(n+1) \times (n+1)$  matrix  $\mathbf{P}_i$  satisfies the Riccati equation :

$$\mathbf{P}_i \bar{A}_i + \bar{A}_i^T \mathbf{P}_i + \mathbf{Q} - \mathbf{P}_i \bar{B}_i R^{-1} \bar{B}_i^T \mathbf{P}_i = 0. \quad (8)$$

Introduce an automatic choosing function of gradient optimization type:

$$I_i(x) = \prod_{j=1}^L \left\{ 1 - \frac{1}{1 + \exp(2N_i(C_j(x) - a_{ij}))} - \frac{1}{1 + \exp(-2N_i(C_j(x) - b_{ij}))} \right\} \quad (9)$$

where  $N_i$ : positive real value,  $-\infty \leq a_{ij}$ ,  $b_{ij} \leq \infty$ .  $I_i(x)$  is analytic and almost unity on  $C^{-1}(D_i)$ , otherwise almost zero (see Fig. 2).

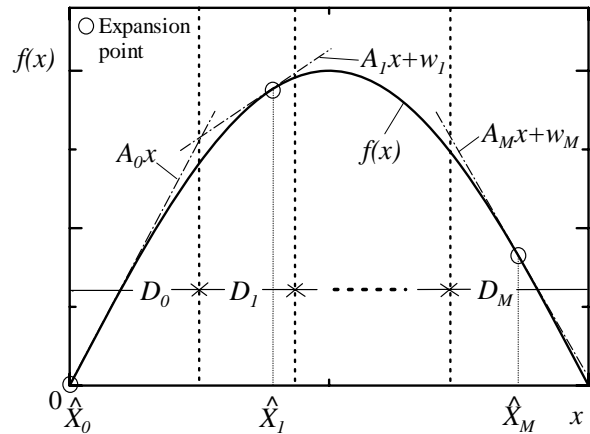

Fig. 1 Sectionwise linearization

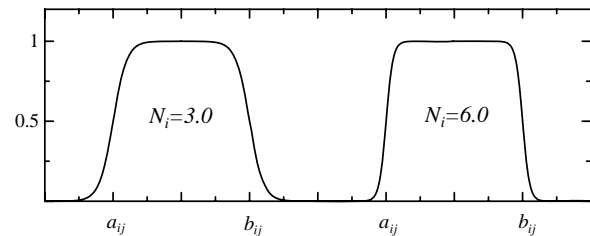

Fig. 2 Automatic Choosing Function ( $N_i=3.0, 6.0$ )

Uniting  $\{u_i(\mathbf{X})\}$  of (7) with  $\{I_i(x)\}$  of (9), we have an augmented automatic choosing control

$$u(\mathbf{X}) = \sum_{i=0}^M u_i(\mathbf{X}) I_i(x). \quad (10)$$

### III. PARAMETER SELECTION BY GA

The Hamiltonian for Eqs.(3) and (4) is given by

$$H(\mathbf{X}, u, \lambda) = \frac{1}{2} (\mathbf{X}^T \mathbf{Q} \mathbf{X} + u^T R u) + \lambda^T (\bar{f}(\mathbf{X}) + \bar{g}(\mathbf{X})u). \quad (11)$$

Assume that the adjoint vector  $\lambda \in R^{n+1}$  is

$$\lambda = \sum_{i=0}^M \mathbf{P}_i \mathbf{X} I_i(x). \quad (12)$$

The necessary condition of the optimality is  $\partial H / \partial u = 0$  or  $u = -R^{-1} \bar{g}(\mathbf{X})^T \lambda$ , which derives Eq.(10) using Eq.(12) and

$$H(\mathbf{X}, u, \lambda) = \frac{1}{2} \mathbf{X}^T \mathbf{Q} \mathbf{X} - \frac{1}{2} u^T R u + \bar{f}^T(\mathbf{X}) \lambda \quad (13)$$

using Eq.(11).

Thus we can define a performance

$$PI = \int_{\mathbf{D}} |H(\mathbf{X}, u, \lambda)| / \mathbf{X}^T \mathbf{X} d\mathbf{X}. \quad (14)$$

A set of parameters included in the control of Eq.(10) is

$$\bar{\Omega} = \{M, N_i, a_{ij}, b_{ij}, \hat{X}_i\} \quad (15)$$

which is suboptimally selected by minimizing  $PI$  with the aid of GA[9] as follows.

<ALGORITHM>

**step1:Apriori:** Set values  $\bar{\Omega}_{apriori}$  appropriately.

**step2:Parameter:** Choose  $\Omega \subset \bar{\Omega}$  to be improved and rewrite

$$\Omega = \{N_i, a_i, b_i \dots\} = \{\alpha_k : k = 1, \dots, K\}.$$

**step3:Coding:** Represent each  $\alpha_k$  with a binary bit string of  $\tilde{L}$  bits and then arrange them into one string of  $\tilde{L}K$  bits.

**step4:Initialization:** Randomly generate an initial population of  $\tilde{q}$  strings

$$\{\Omega_p : p = 1, \dots, \tilde{q}\}.$$

**step5:Decoding:** Decode each element  $\alpha_k$  of  $\Omega_p$  by

$$\alpha_k = (\alpha_{k,max} - \alpha_{k,min})A_k / (2^{\tilde{L}} - 1) + \alpha_{k,min}$$

where  $\alpha_{k,max}$ :maximum,  $\alpha_{k,min}$ :minimum, and  $A_k$ :decimal values of  $\alpha_k$ .

**step6:Control:** Design  $u = u(\mathbf{X})_p$  ( $p = 1, \dots, \tilde{q}$ ) for  $\Omega_p$  by using Eq.(10).

**step7:Adjoint:** Make  $\lambda = \lambda(\mathbf{X})_p$  ( $p = 1, \dots, \tilde{q}$ ) for  $\Omega_p$  by using Eq.(11).

**step8:Fitness value calculation:** Calculate

$$PI_p = \int_{\mathbf{D}} \left| \frac{1}{2} \mathbf{X}^T \mathbf{Q} \mathbf{X} - \frac{1}{2} u(\mathbf{X})_p^T R u(\mathbf{X})_p + \bar{f}^T(\mathbf{X}) \lambda(\mathbf{X})_p \right| / \mathbf{X}^T \mathbf{X} d\mathbf{X} \quad (16)$$

by Eqs.(13) and (14), or fitness  $F_p = -PI_p$ . Integration of (16) is approximated by a finite sum.

**step9:Reproduction:** Reproduce each of individual strings with the probability of

$$F_p / \sum_{j=1}^{\tilde{q}} F_j.$$

**step10:Crossover:** Pick up two strings and exchange them at a crossing position by a crossover probability  $P_c$ .

**step11:Mutation:** Alter a bit of string (0 or1) by a mutation probability  $P_m$ .

**step12:Repetition:** Repeat step5~step11 until prespecified  $G$ -th generation. If unsatisfied, go to step2.

As a result, we have a suboptimal control  $u(\mathbf{X})$  for the string with the best performance over all the past generations.

IV. NUMERICAL EXAMPLE

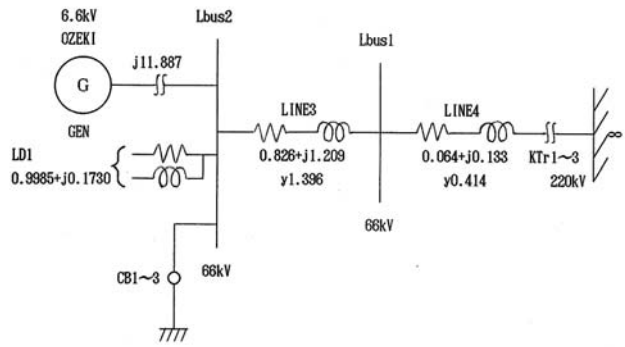

Fig. 3 Diagram of Ozeki-Power-Plant

Consider a field excitation control problem of power system. Fig. 3 is a diagram of Ozeki-Power-Plant of Kyushu Electric Power Company in Japan. This system is assumed to be described[8] by

$$\begin{aligned} \tilde{M} \frac{d^2 \delta}{dt^2} + \tilde{D} \frac{d\delta}{dt} + P_e &= P_{in} \\ P_e &= E_I^2 Y_{11} \cos \theta_{11} + E_I \tilde{V} Y_{12} \cos(\theta_{12} - \delta) \\ E_I + T'_{d0} \frac{dE'_q}{dt} &= E_{fd} \\ E_I &= E'_q + (X_d - X'_d) I_d \\ I_d &= -E_I Y_{11} \sin \theta_{11} - \tilde{V} Y_{12} \sin(\theta_{12} - \delta) \\ \tilde{D} &= \tilde{V}^2 \left\{ \frac{T''_{d0} (X'_d - X''_d)}{(X'_d + X_e)^2} \sin^2 \delta \right. \\ &\quad \left. + \frac{T''_{q0} (X_q - X''_q)}{(X_q + X_e)^2} \cos^2 \delta \right\}, \end{aligned}$$

where  $\delta$ : phase angle,  $\dot{\delta}$ : rotor speed,  $\tilde{M}$ : inertia coefficient,  $\tilde{D}(\delta)$ : damping coefficient,  $P_{in}$ : mechanical input power,  $P_e(\delta)$ : generator output power,  $\tilde{V}$ : reference bus voltage,  $E_I$ : open circuit voltage,  $E_{fd}$ : field excitation voltage,  $X_d$ : direct axis synchronous reactance,  $X'_d$ : direct axis transient reactance,  $X_e$ : external impedance,  $Y_{11} \angle \theta_{11}$ : self-admittance of the network,  $Y_{12} \angle \theta_{12}$ : mutual admittance of the network, and  $I_d(\delta)$ : direct axis current of the machine. Put  $x = [x[1], x[2], x[3]]^T = [E_I - \hat{E}_I, \delta - \hat{\delta}_0, \dot{\delta}]^T$  and  $u = E_{fd} - \hat{E}_{fd}$ , so that

$$\begin{bmatrix} \dot{x}[1] \\ \dot{x}[2] \\ \dot{x}[3] \end{bmatrix} = \begin{bmatrix} f_1(x) \\ f_2(x) \\ f_3(x) \end{bmatrix} + \begin{bmatrix} g_1(x) \\ 0 \\ 0 \end{bmatrix} u \quad (17)$$

where

$$\begin{aligned} f_1(x) &= -\frac{1}{kT_{d0}} (x[1] + \hat{E}_I - \hat{E}_{fd}) \\ &\quad + \frac{(X_d - X'_d) \tilde{V} Y_{12}}{k} X_3 \cos(\theta_{12} - x[2] - \hat{\delta}_0) \\ f_2(x) &= x[3] \\ f_3(x) &= -\frac{\tilde{V} Y_{12}}{M} (x[1] + \hat{E}_I) \cos(\theta_{12} - x[2] - \hat{\delta}_0) \\ &\quad - \frac{Y_{11} \cos \theta_{11}}{M} (x[1] + \hat{E}_I)^2 - \frac{\tilde{D}}{M} x[3] + \frac{P_0}{M} \\ g_1(x) &= \frac{1}{kT_{d0}}, \quad k = 1 + (X_d - X'_d) Y_{11} \sin \theta_{11}. \end{aligned}$$

Parameters are

$$\begin{aligned} \tilde{M} &= 0.016095[pu] & T_{d0} &= 5.09907[sec] \\ \tilde{V} &= 1.0[pu] & P_0 &= 1.2[pu] \\ X_d &= 0.875[pu] & X'_d &= 0.422[pu] \\ Y_{11} &= 1.04276[pu] & Y_{12} &= 1.03084[pu] \\ \theta_{11} &= -1.56495[pu] & \theta_{12} &= 1.56189[pu] \\ X_e &= 1.15[pu] & X''_d &= 0.238[pu] \\ X_q &= 0.6[pu] & X''_q &= 0.3[pu] \\ T'_{d0} &= 0.0299[pu] & T''_{q0} &= 0.02616[pu] \\ \hat{E}_I &= 1.52243[pu] & \hat{\delta}_0 &= 48.57^\circ \\ \hat{\delta}_0 &= 0.0[deg/sec] & \hat{E}_{fd} &= 1.52243[pu]. \end{aligned}$$

Set  $\mathbf{X} = [x^T, x[4]]^T = [x[1], x[2], x[3], x[4]]^T$ ,  $n = 3$ ,  $\hat{X}_0 = \hat{\delta}_0 = 48.57^\circ$ ,  $C(x)=x[2]$ ,  $L = 1$ ,  $\mathbf{Q}=\text{diag}(1, 1, 1, 1)$ ,  $R=1$ ,  $\sigma_i = 0.33294(0 \leq i \leq M)$ , and  $x[4](0)=1$ . Experiments are carried out for the new control(AACC), and the ordinary linear optimal control(LOC)[2].

1) AACC( $N_i$  : GA):

$M=1$ ,  $\hat{X}_1 = 80^\circ$ ,  $D_0 = (-\infty, a - \hat{\delta}_0)$ ,  $D_1=[a - \hat{\delta}_0, \infty)$ . The parameters are suboptimally selected along the algorithm of section III.  $\Omega=\{N_i, a\}$ ,  $G=100$ ,  $\tilde{q}=100$ ,  $\tilde{L}=8$ ,  $P_c=0.8$ ,  $P_m=0.03$ ,  $\mathbf{D}=[0.0, 2.0] \times [-0.5, 2.0] \times [-5.0, 5.0] \times [0.0, 1.5]$ . It results that  $N_0=2.517647$ ,  $N_1=1.035294$  and  $\hat{a}=74.215686^\circ$ .

2) AACC( $N_i$  : fix):

The parameters are suboptimally selected by using the same way of the AACC( $N_i$  : GA) which uses the fixed gradient of the automatic choosing function[7].  $\Omega=\{N, a\}$ . It results that  $N=4.882353$  and  $\hat{a}=75.0^\circ$ .

Table1 shows performances by the AACC( $N_i$  : GA), the AACC( $N_i$  : fix) and the LOC. The cost function of Table1 is

$$\tilde{J} = \frac{1}{2} \int_0^{25} (\mathbf{X}^T \mathbf{Q} \mathbf{X} + u^T \mathbf{R} u) dt.$$

Figs. 4, 5 and 6 show the responses in case of  $x^T(0) = [0, 1.2, 0]$ . Figs. 7, 8 and 9 show the responses in case of  $x^T(0) = [0, 1.0, -5]$ . Figs. 10, 11 and 12 show the responses in case of  $x^T(0) = [0, 1.298, 0]$ . These results indicate that the AACC( $N_i$  : GA) is better than the AACC( $N_i$  : fix) and LOC.

### V. CONCLUSIONS

We have studied an augmented automatic choosing control using the automatic choosing functions of gradient optimization type for nonlinear systems. This approach was applied to a field excitation control problem of power system to demonstrate the splendiness of the AACC. Simulation results have shown that this controller could improve performance remarkably well.

### REFERENCES

[1] Y. N. Yu, K. Vongsuriya and L. N. Wedman, "Application of an Optimal Control Theory to a Power System", *IEEE Trans. Power Apparatus and Systems*, 89-1, pp.55-62, 1970.  
 [2] A. P. Sage and C. C. White III, "Optimum Systems Control (2nd edition)", *Prentice-Hall, Inc.*, 1977.  
 [3] M. Vidyasagar, "Nonlinear Systems Analysis", *Prentice-Hall, Inc.*, 1978.  
 [4] K.Glover and J.C.Doyle, "State-Space Formula for All Stabilizing Controllers that Satisfy and  $H_\infty$ -norm Bound and Relations to Risk Sensitivity", *System & Letters*, Vol.11-2, pp.167-172, 1988.

[5] A.Isidori, "Nonlinear Control Systems : An Introduction (2nd edition)", *Springer-Verlag*, 1989.  
 [6] H.Takata, "Automatic Choosing Control Design via GA for Nonlinear Systems", *Proc.38th IEEE CDC*, pp.5301-5306, 1999.  
 [7] H.Takata and T.Nawata, An Augmented Automatic Choosing Control Using Zero Dynamics for Nonlinear Systems, *Proc. 2001 NOLTA*, pp.649-652, 2001.  
 [8] T.Nawata and H.Takata, An Augmented Automatic Choosing Control Using Zero Dynamics for Nonlinear Systems and Its Application to a Power System, *Proc. 22nd IASTED MIC*, pp.191-196, 2003.  
 [9] D. E. Goldberg, "Genetic Algorithms in Search, Optimization, and Machine Learnings", *Addison-Wesley Pub. Co. Inc.*, 1989.

**Toshinori Nawata** received his B.S.degree in Computer Science from Kyushu Institute of Technology in 1990 and his Dr. Eng. degree in System Information Engineering from Kagoshima University in 2003. He is currently an Associate Professor at the Department of Human-Oriented Information Systems Engineering, Kumamoto National College of Technology. His reserch interests include the nonlinear system control theory. Dr. Nawata is a member of IEEJ, IEICE and ISClE.

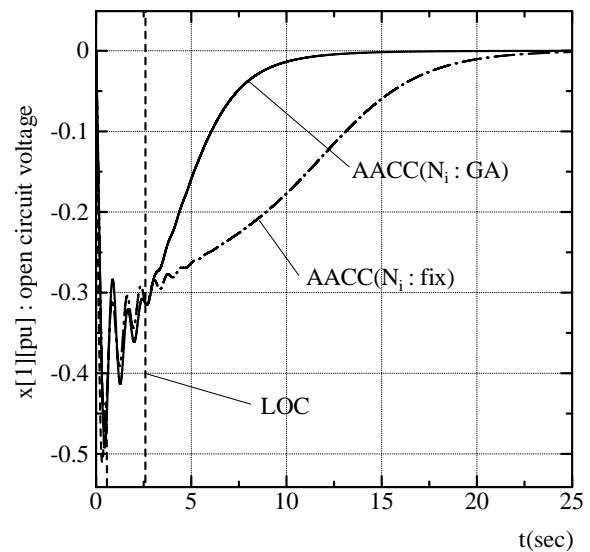

Fig. 4 Responses of LOC, AACC( $N_i$  : fix), AACC( $N_i$  : GA) ( $x^T(0) = [0, 1.2, 0]$ )

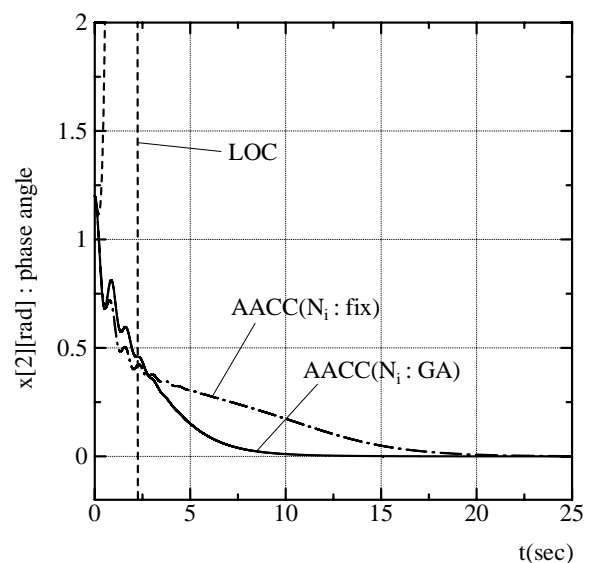

Fig. 5 Responses of LOC, AACC( $N_i$  : fix), AACC( $N_i$  : GA) ( $x^T(0) = [0, 1.2, 0]$ )

TABLE I  
 PERFORMANCES

Method	$x^T(0)$ : initial point				
	[0, 0.4, 0]	[0, 0.5, 0]	[0, 1.0, -5]	[0, 1.2, 0]	[0, 1.298, 0]
LOC	0.95375	×	×	×	×
AACC( $N_i$ : fix)	0.94691	1.35947	7.60293	2.31948	×
AACC( $N_i$ : GA)	0.94224	1.23581	7.19167	1.90626	2.84883

× : very large value

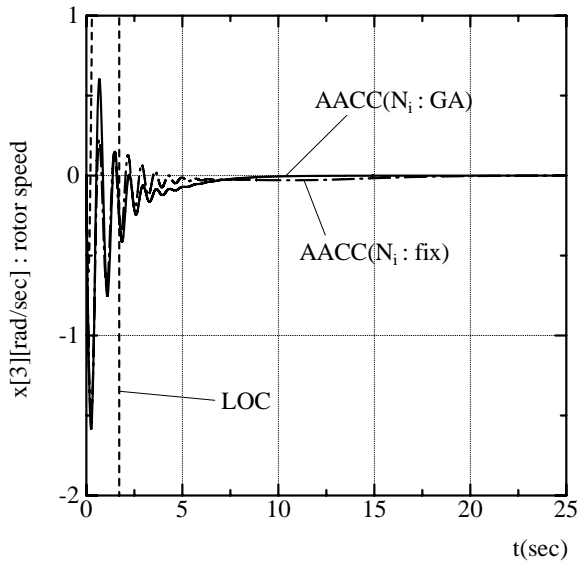

Fig. 6 Responses of LOC, AACC( $N_i$  : fix), AACC( $N_i$  : GA)  
 ( $x^T(0) = [0, 1.2, 0]$ )

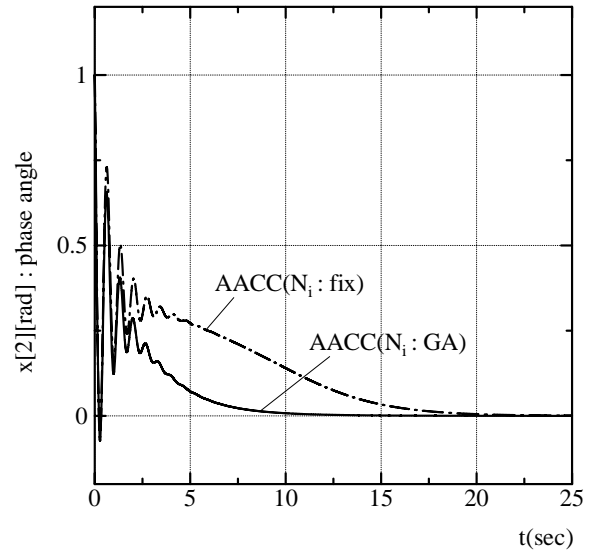

Fig. 8 Responses of AACC( $N_i$  : fix), AACC( $N_i$  : GA)  
 ( $x^T(0) = [0, 1.0, -5]$ )

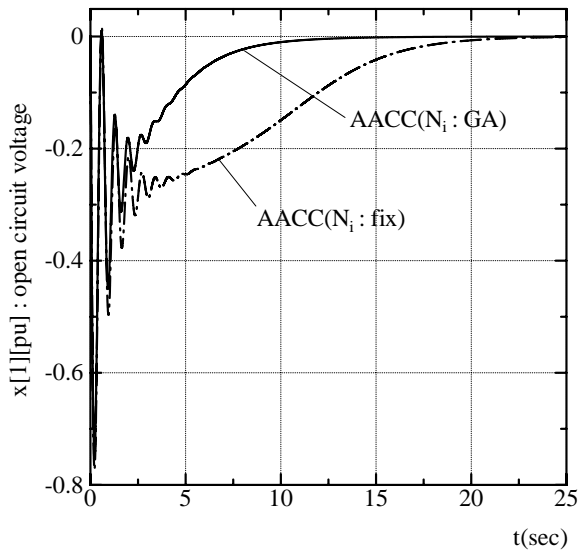

Fig. 7 Responses of AACC( $N_i$  : fix), AACC( $N_i$  : GA)  
 ( $x^T(0) = [0, 1.0, -5]$ )

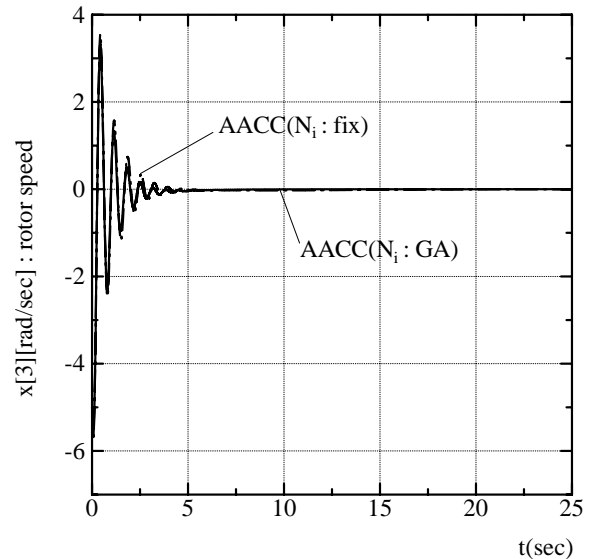

Fig. 9 Responses of AACC( $N_i$  : fix), AACC( $N_i$  : GA)  
 ( $x^T(0) = [0, 1.0, -5]$ )

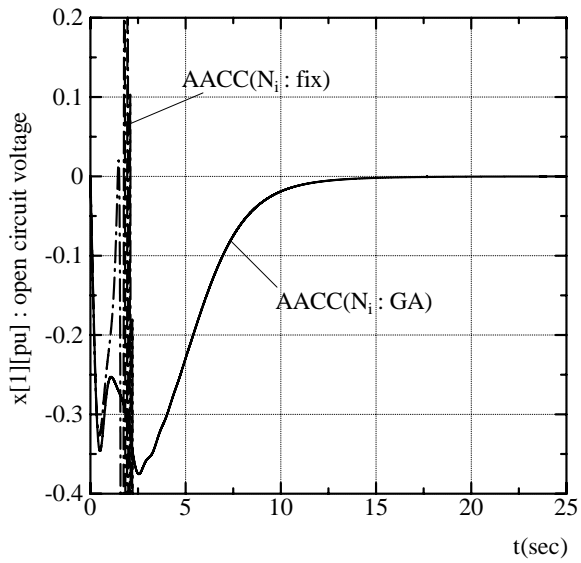

Fig.10 Responses of AACC( $N_i$  : fix), AACC( $N_i$  : GA)  
 $(x^T(0) = [0, 1.298, 0])$

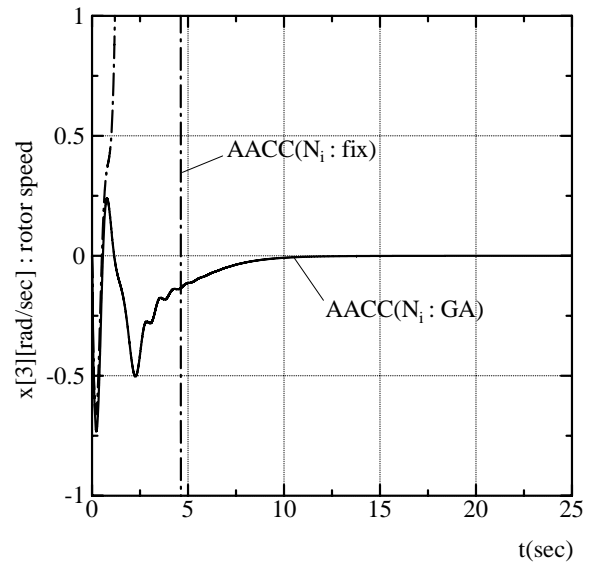

Fig.12 Responses of AACC( $N_i$  : fix), AACC( $N_i$  : GA)  
 $(x^T(0) = [0, 1.298, 0])$

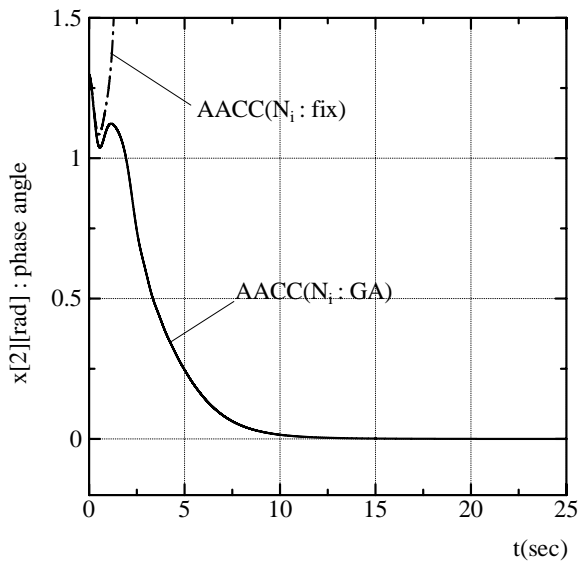

Fig.11 Responses of AACC( $N_i$  : fix), AACC( $N_i$  : GA)  
 $(x^T(0) = [0, 1.298, 0])$