

# Numerical Analysis for the Performance of a Thermoelectric Generator According to Engine Exhaust Gas Thermal Conditions

Jinkyu Park, Yungjin Kim, Byungdeok In, Sangki Park and Kihyung Lee\*

**Abstract**—Internal combustion engines rejects 30-40% of the energy supplied by fuel to the environment through exhaust gas. thus, there is a possibility for further significant improvement of efficiency with the utilization of exhaust gas energy and its conversion to mechanical energy or electrical energy. The Thermo-Electric Generator (TEG) will be located in the exhaust system and will make use of an energy flow between the warmer exhaust gas and the external environment. Predict to th optimum position of temperature distribution and the performance of TEG through numerical analysis. The experimental results obtained show that the power output significantly increases with the temperature difference between cold and hot sides of a thermoelectric generator.

**Keywords**—Thermoelectric generator, Numerical analysis, Seebeck coefficient, Figure of merit

## I. INTRODUCTION

THE worldwide trend intends to tighten even vehicle fuel consumption with regulations to reduce CO<sub>2</sub> gas which is a main factor of global warming. In case of internal combustion engines, only 30-40% of fuel energy can be converted into useable power and the others are wasted as cooling loss from coolant and exhaust gas. Therefore vehicle engine efficiency could be improved with minimizing the loss of coolant and exhaust gas. In present day, technologies to use the wasted energies of the vehicle have been attracting [1].

Hi-Z Technology Inc. developed an 1kW-thermoelectric generation system using a wasted thermal energy of a heavy duty diesel engine instead of using mechanical electric generator and as a result, they finally improved fuel consumption [2]. Douglas et al. studied a combination technology of a generator and TEG using a passenger car [3]. Richard drew a result of increasing in 6% of fuel consumption with numerical analysis using a thermo-electric regenerator of a passenger car [4].

Jinkyu Park, Department of mechanical engineering, Hanyang university, Seoul, Korea (e-mail: jojijkp2001@naver.com).

Yungjin Kim, Department of mechanical engineering, Hanyang university, Seoul, Korea (e-mail: eliotkyj@hanyang.ac.kr).

Byungdeok In, Department of mechanical engineering, Hanyang university, Seoul, Korea (e-mail: sirusony@hanmail.net).

Sangki Park, Department of mechanical engineering, Hanyang university, Seoul, Korea (e-mail: pak3391@gmail.com).

Kihyung Lee, Department of mechanical engineering, Hanyang university, Seoul, Korea (Corresponding author; phone: +82-31-418-9293; fax: +82-31-400-4064; e-mail: hylee@hanayng.ac.kr).

Thermoelectric generator to improve fuel economy is an energy converting device which can directly convert thermal energy into electric energy and so it could be one of the environmental - friendly technologies generating electric power without using any other extra energy source and mechanical equipment.

The principle of thermoelectric generating is an electric flow from heat absorption and generation phenomena of thermoelectric module using Seebeck effect which electromotive force is occurred by temperature difference between both ends of two different thermoelectric devices.

In this study, we could expect the efficiency of a thermoelectric generator using a simulation modeling before taking an experiment with a real thermoelectric generator.

## II. NUMERICAL ANALYSIS AND METHOD

### A. Modeling of Numerical Analysis

In this study, WAVE simulation modeling of Ricardo was used to expect the performance of the thermoelectric generator with 2 liter common rail type diesel engine shown in Fig. 1. The engine bore and stroke were set as 83mm and 92mm, the compression ratio was set as 18.4 appeared in TABLE I. The temperature of the air-fuel mixture was set as 350K. The injector nozzle size and spray angle were 0.1mm and 40°.

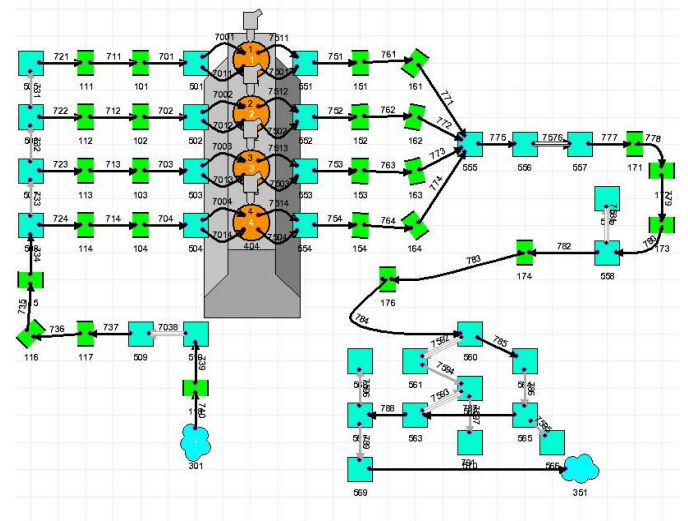

Fig. 1 Diagram of simulation modeling

TABLE I  
 SPECIFICATION OF ENGINE

Contents	Condition
Displacement	2000 cc
Bore	83 mm
Stroke	92 mm
Injection duration (msec)	18.4

### B. Method of Numerical Analysis

We organized several test conditions to carry out a simulation modeling as follows. At first, the target engine speed was increased from 1000rpm to 4000rpm and the data was acquired every 500rpm increased while the exhaust gas temperature was varied at 4 different positions of the exhaust pipe line. The first setting position was for the pure combustion gas condition and the others were set at further positions of ducts from the exhaust port.

For the second, we drew results from the exhaust gas obtained under the estimation, which the thermoelectric module was belonging to the same chain as Bi<sub>2</sub>Te<sub>3</sub>, to explain the principle of thermoelectric generating, which an electric flow occur from heat absorption and generation phenomena of the thermoelectric module. The temperature of the lower temperature part of the module was selected as 120 °C.

The performance equations of thermoelectric generating appear as following equations [5]-[7]. The Seebeck coefficient ( $\alpha$ ) and electric resistance (R) could be calculated experimentally from (1) [8]. The Seebeck coefficient was calculated with the temperature difference between both ends of a thermoelectric device and the voltage (V) at non-load condition (I=0). The electric resistance of the thermoelectric device module was calculated from the average value of the electric resistance appeared.

$$P = VI = (\alpha \Delta T - IR)I \quad (1)$$

$$Z = \alpha^2 \theta / R \quad (2)$$

$$Q_h = \alpha T_h + \frac{\Delta T}{\theta} - \frac{1}{2} I^2 R \quad (3)$$

### III. RESULT AND DISCUSSION

Fig. 2 shows the variation of exhaust gas temperature according to various thermal conditions. As shown in Fig. 2, Duct 777 has a little temperature variation but other conditions have big temperature variation. Therefore when the thermoelectric module was applied; it was possible to predict a high consistent temperature could be used at the duct 777. So the performance result of the thermoelectric module was anticipated using the temperature of duct 777. Accordingly, when the thermoelectric module was applied to a commercial vehicle, advantages of efficiency and performance could be expected from the duct 777 position.

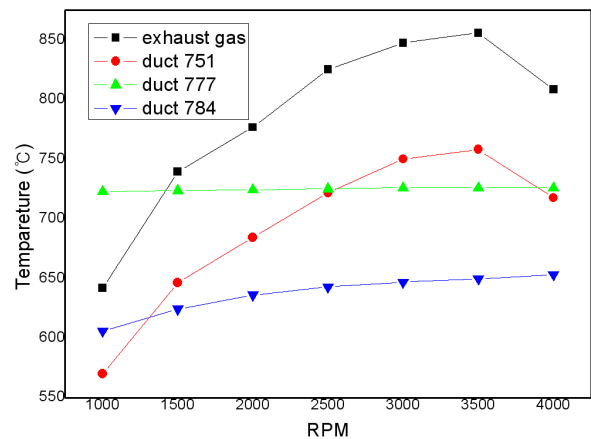

Fig. 2 Diagram of simulation modeling

Fig. 3 and 4 show the Seebeck coefficient and electrical resistance of the thermoelectric module, and Fig. 5 shows the figure of merit to the thermoelectric module.

Seebeck coefficient was decreased according to RPM increased, thereafter the values of Seebeck coefficient were almost same over 3000 rpm. Also electrical resistance and figure of merit was kept similar after decreasing. Accordingly, figure of merit with Seebeck coefficient and electrical resistance of the thermoelectric module was excellent at lower RPMs.

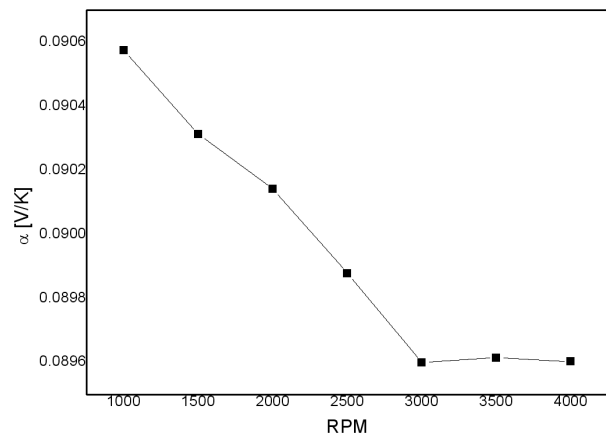

Fig. 3 Seebeck coefficient of TEM

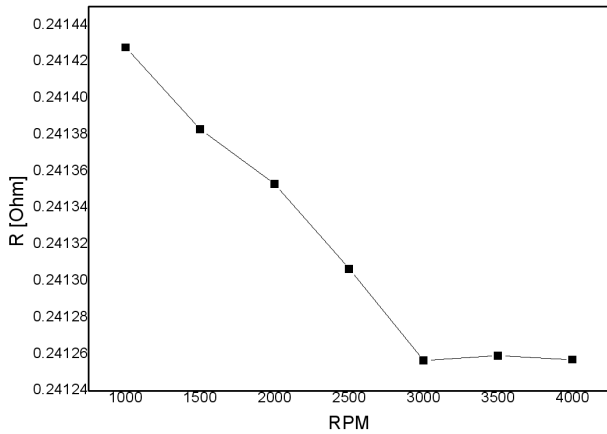

Fig. 4 Electrical resistance of TEM

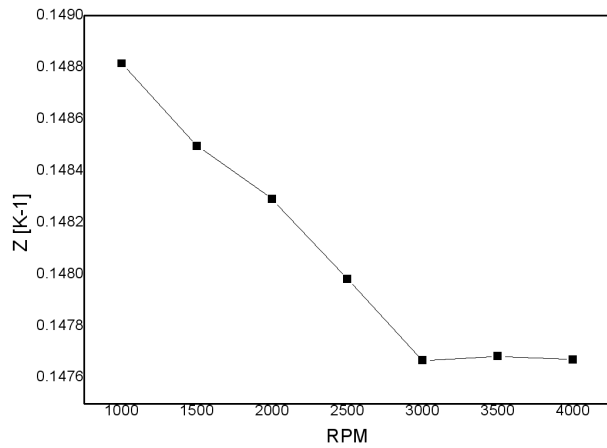
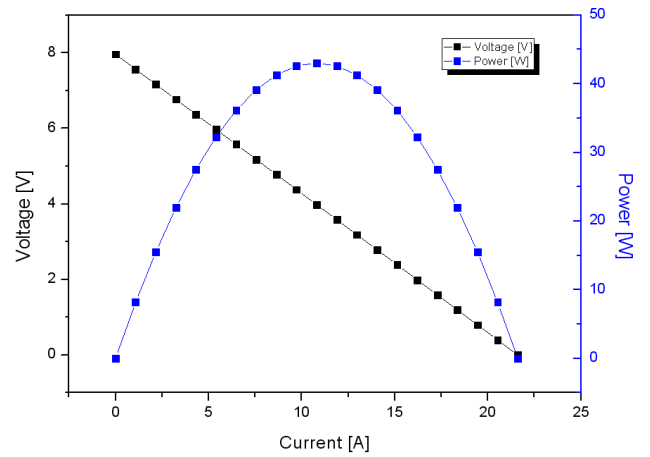
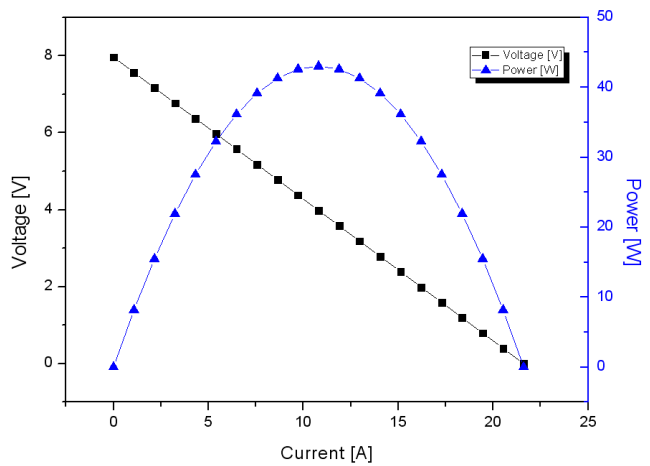

Fig. 5 Figure of merit



(a) Engine speed: 1000 rpm



(b) Engine speed: 1500 rpm

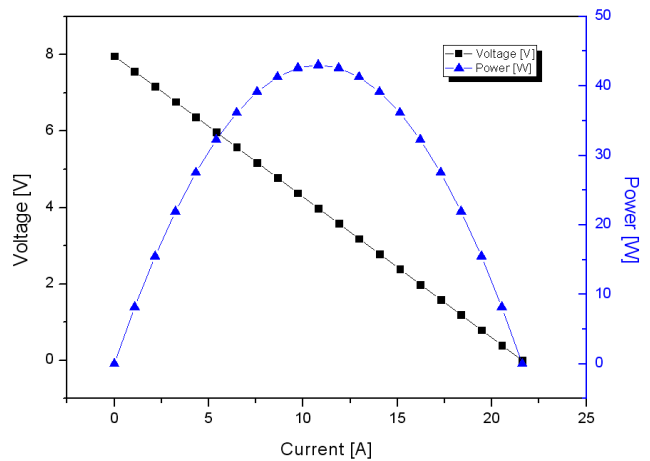

(c) Engine speed: 2000 rpm

Fig. 6 shows the performance curve of the thermoelectric generator according to the temperature difference between cold and hot sides of the thermoelectric module. Output voltage was linearly decreased according to current value increased; the value of output power was increased then decreased after the maximum power at the current of about 12A. It means the peak characteristic of output power exists in process of output power generation in all cases, and moreover, the maximum value of each condition is almost same because the temperature of high heat source is constant. From this result, it was concluded that the difference of the thermal condition including temperature between both ends of the thermoelectric module is most important factor in the thermoelectric generation performance to make electric power.

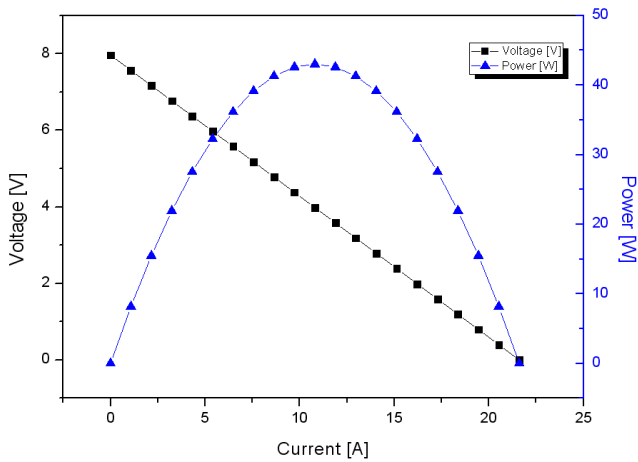

(d) Engine speed: 2500 rpm

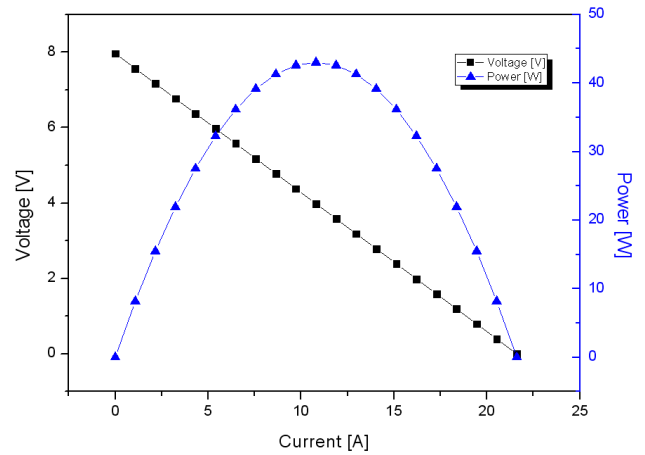

(g) Engine speed: 4000 rpm

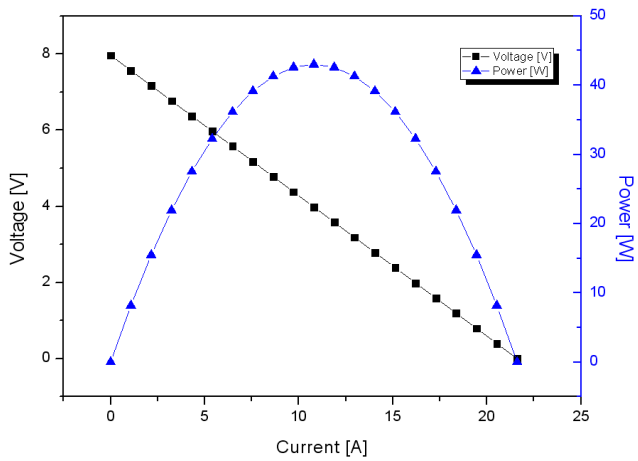

(e) Engine speed: 3000 rpm

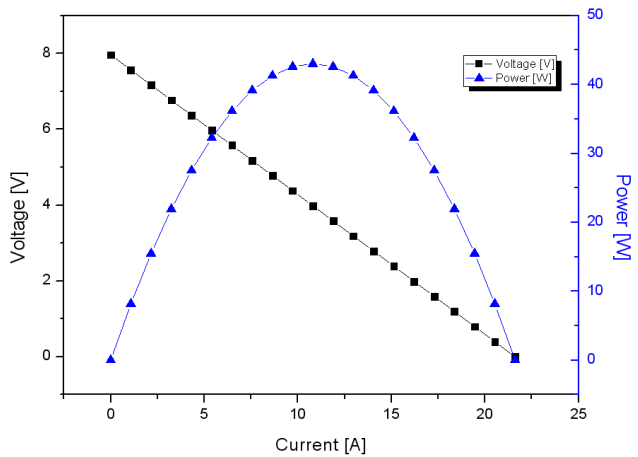

(f) Engine speed: 3500 rpm

Fig. 6 Performance curves according to RPM

This calculation result could not be well matched with that in real situation and it could be difficult to apply to vehicles, however, thermoelectric generators could be used as a part of heat recovery system for vehicles near future after developing better materials and efficiency or decreasing the price.

#### IV. CONCLUSIONS

In this research, the performance of a thermoelectric module was investigated with the characteristics of exhaust gas temperature anticipated by simulation modeling. Constant temperature positions of the exhaust pipe line were found and then Seebeck coefficient, electrical resistance, figure of merit, electric power and voltage of the thermoelectric module was understood.

- 1) Exhaust gas temperature was surveyed from various parts of exhaust pipe line. From the result, duct 777 was maintained a low temperature variation and constant temperature. Therefore the thermoelectric module could get constant performance and efficiency at duct 777.
- 2) Figure of merit, electrical resistance and Seebeck coefficient of the thermoelectric module decreased with increasing engine speed and they became constant at over 3000rpm. It shows the lower engine speed makes larger values of them.
- 3) Output voltage was linearly decreased according to current value increased; the value of output power was increased then decreased after the maximum power at the current of about 12A. The maximum value of each condition is almost same because the temperature of high heat source is constant.
- 4) The difference of the thermal condition including temperature between both ends of the thermoelectric module is most important factor in the thermoelectric generation performance to make electric power.

- 5) A development of materials and an increase of the efficiency for the thermoelectric module should be needed to apply to the real heat recovery system for vehicles.

#### ACKNOWLEDGMENT

This work was supported by the National Research Foundation of Korea(NRF) grant funded by the Korea government(MEST).

#### REFERENCES

- [1] Endo, T., Kwajiri, S., Kojima, Y., Takahashi, K. et al., "Study on Maximizing Exergy in Automotive Engines," *SAE Technical Paper*, 2007-01-0257, 2007.
- [2] Aleksandr, S.K., John, C.B., Saeid, G., Norbert, B.E., Richard, A.B., David, F., Mike, M., "Thermoelectric Development ay Hi-Z Technology," *Technical Paper*, 2001
- [3] Crane, D., Jackson, G., and Holloway, D., "Towards Optimization of Automotive Waste Heat Recovery Using Thermoelectrics," *SAE Technical Paper*, 2001-01-1021, 2001
- [4] Stobert, R. and Milner, D., "The Potential for Thermo-Electric Regeneration of Energy in Vehicles," *SAE Technical Paper*, 2009-01-1333, 2009.
- [5] Rowe, D. M., "Thermoelectric Handbook Macro to Nano," *Taylor and Francis Group Press, Wales*, 2007.
- [6] Bass, J. C., Elsner, N. B. and Leavitt, F. A., "Performance of the 1kW thermoelectric generator for diesel engines," *Proceedings of the 13th International Conference on Thermoelectrics*, pp. 295-298, 1994.
- [7] Wu, C., "Analysis of waste-heat thermoelectric power generators," *Applied Thermal Eng.*, Vol. 16, No. 1, pp. 63-69, 1996.
- [8] Huang, B. J. Chin, C. J., and Duang, C. L., "A design method of thermoelectric cooler," *Int. J. Refrigeration*, Vol. 23, pp. 208-218, 2000.