

Preparation and Evaluation of New Nanocatalysts for Selective Oxidation of H₂S to Sulfur

Mohammad Rezaee, Mohammad Kazemeini, Ali Morad Rashidi and Moslem Fattahi

Abstract—Selective oxidation of H₂S to elemental sulfur in a fixed bed reactor over newly synthesized alumina nanocatalysts was physio-chemically investigated and results compared with a commercial Claus catalyst. Amongst these new materials, Al₂O₃-supported sodium oxide prepared with wet chemical technique and Al₂O₃ nanocatalyst prepared with spray pyrolysis method were the most active catalysts for selective oxidation of H₂S to elemental sulfur. Other prepared nanocatalysts were quickly deactivated, mainly due to the interaction with H₂S and conversion into sulfides.

Keywords—H₂S, Claus process, Al₂O₃, Spray pyrolysis method, Wet chemical technique

I. INTRODUCTION

HYDROGEN sulfide is a highly poisonous and corrosive gas, which causes serious damage to process equipment. There are various methods to remove hydrogen sulfide from gas streams such as adsorption, direct conversion and reversible absorption. Hydrogen sulfide is usually removed by the famous Claus process in industry [1, 2]. The Claus process consists of two steps: thermal oxidation (*i.e.*; Equation (1)) and catalytic reaction (*i.e.*; Equation (2)). In the thermal oxidation step, one-third of the hydrogen sulfide is first burned with air to sulfur dioxide in a waste heat furnace. Then in the catalytic reaction step, SO₂ is reacted with unconverted H₂S to elemental sulfur over an Al₂O₃ catalyst. However, due to thermodynamic limitations, only 95-97% of H₂S might be converted into sulfur.

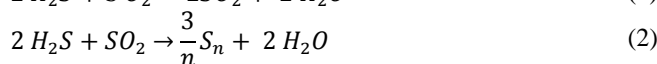
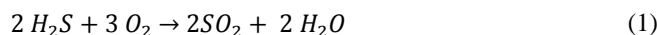

M. Rezaee is with the Department of Chemical and Petroleum Engineering, Sharif University of Technology, Azadi Avenue, P.O. Box 11365-9465, Tehran, Iran.

M. Kazemeini is with the Department of Chemical and Petroleum Engineering, Sharif University of Technology, Azadi Avenue, P.O. Box 11365-9465, Tehran, Iran (corresponding author to provide phone: +98-21-6616-5425; fax: +98-21-6602-2853; e-mail: kazemini@sharif.edu).

A.M. Rashidi is with the Nanotechnology Research Center, Research Institute of Petrochemical Industry (RIPI), Tehran, Iran (e-mail: rashidiam@ripi.ir).

M. Fattahi is with the Department of Chemical and Petroleum Engineering, Sharif University of Technology, Azadi Avenue, P.O. Box 11365-9465, Tehran, Iran (e-mail: moslemfattahi@che.sharif.edu).

In order to increase fractional conversion of hydrogen sulfide to elemental sulfur in comparison with the Claus process a single step selective oxidation of H₂S to elemental sulfur which is practically irreversible and does not have thermodynamic limitations have been developed. Synthesis of active and selective catalysts for this oxidation process is indeed necessary in order to increase conversion of H₂S to elemental sulfur.

Recently, a TiO₂/SiO₂ catalyst with stoichiometric amount of oxygen has been investigated and has shown good activity [3]. The Ce-V mixed oxide with a V/Ce atomic ratio of one and with the CeVO₄ crystal structure gave very high sulfur selectivity values (close to one) at almost complete conversion of H₂S, for O₂/H₂S mole ratios close to 0.5 [4].

In the present study, several alumina nanocatalyst were prepared and their activity compared with the commercial Claus catalyst. Nano alumina particles with three methods consisted of wet chemical, co-precipitation and spray pyrolysis were synthesized. In spray pyrolysis method a setup made and based on statistical design of experiments (Box-Behnken design), the best alumina based catalyst with the highest BET surface area in the H₂S oxidation setup utilized.

II. EXPERIMENTAL

A. Catalyst Preparation

Three alumina nano-particles catalysts were prepared by wet chemical, co-precipitation and spray pyrolysis method. In wet chemical method 5g aluminum chloride hexahydrate (97%, supplied by the Aldrich Chemical) was dissolved in 325ml distilled water at 55°C. A mixture of 2g sorbitol and 5g ammonia were added drop wise to the first solution. The desired pH value of the solution reached through adding NH₄OH. Then temperature of solution was raised to 70°C under vigorous stirring and insulating with aluminum foil. The resulting precipitate was left under fast agitation for 10 minutes and was then filtered and washed to get neutralized. This precipitate was washed with a solution of 100ml ethanol and 100ml distilled water. This was then dried at 60°C for 24h and calcined at 600°C for 4h to get γ-Al₂O₃. In co-precipitation method 5g aluminum chloride hexahydrate was dissolved into 325ml distilled water at 55°C. Then according to stoichiometry of sodium carbonate with aluminum chloride

hexahydrate 3.29g sodium carbonate was dissolved in the minimum distilled water at 50°C and then sorbitol was added to this solution. Next, this was added drop wise to the first solution. The other steps are like wet chemical method excluding the neutralization step completely.

In Spray Pyrolysis an experimental set-up consisted of: 1) a pressure nozzle, 2) a stainless steel-310 Tube of 2in id and 2m length located in a cylindrical furnace equipped with a static mixer, 3) a gauge pressure, 4) two metering valve for adjusting rate of two solutions, 5) two tanks for holding solutions and a water collector (Fig. 1) was prepared. Statistical design of experiments (box-behken design) utilized in order to screen effects of significant synthesis parameters. 14 runs were tested and for each run BET surface area measured and the best one with the BET surface area of about 395m²/g was tested in H₂S oxidation set up. Three parameters, namely, temperature, concentration and rate, based on the literature reviews were selected [5, 6]. In all experiment two equimolar solutions of aluminum nitrate nonahydrate (Al(NO₃)₃·9H₂O, p.a., 99.997% purity, provided by the Aldrich chemicals) and sodium carbonate (Na₂CO₃ 99.99%, supplied by Merck chemicals) were mixed in a static mixer and then by using a pressure nozzle were sprayed into the reactor. Air was used as a carrier gas in this system. Its pressure was 2 bars. The particles were collected into a water trap at the exhaust of the reactor.

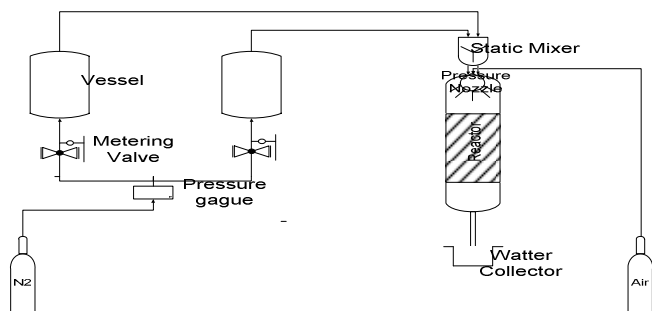

Fig. 1 Schematic representation of the pyrolysis processing equipment used in this work

B. Reactor Test

Selective oxidation of H₂S was carried out in an apparatus working isothermally under atmospheric pressure. A schematic flow diagram of the catalytic oxidation process is shown in Fig. 2. The fixed-bed reactor used for this study was constructed from a stainless steel-316 tube of 12.5mm ID and 450mm length. The gas mixture was passed downwards through the catalytic bed. The reactor was vertically mounted in an electrical furnace; the temperature was controlled by a thermal indicator controller. The flow rates of the gases (O₂, He, H₂S) were monitored and controlled with Bronkhorst mass flow meters linked to a JUMO (d-TRON 304) electronic control units. The catalyst was heated from room to the reaction temperature (heating rate of 5°C/min) in the presence of He. At this point the reactant flow started into the reactor.

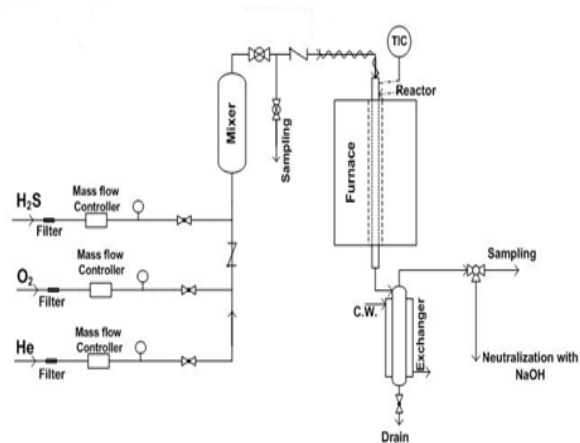

Fig. 2 Schematic diagram of the H₂S oxidation system utilized in this study

C. Catalyst Characterization Techniques

The BET surface areas of the samples were determined by N₂ adsorption at liquid N₂ temperature on a Micromeritics Gemini-2360 Surface area analyzer. Scanning electron microscopy (SEM) micrographs were obtained with a Philips, XL30 device. Gold was used as a conductive material for sample coating. The pore size and surface area measurements were performed with a Micromeritics ASAP-2010 instrument by adsorption of nitrogen at 77K. X-ray powder diffraction measurements were conducted using standard powder diffraction procedure carried out with a Philips Diffractometer PW-1840 (Lump 3ukα, λ=1.54Å). The sulfur content was determined with a high temperature measurement of sulfur content using IR detector and UOP-864 method with a LECO CS600. H₂S concentration was analyzed using a Mettler potentiometer (DL70-ES), with an accuracy of ±1% of ±1mL equipped with an Ag-Ag₂S electrode (DM141-SC) and UOP-163 methods with detection threshold of 0.5 ppm. Product stream was passed through KOH solution (25wt %) at different times each time for 10 min to measure its H₂S content.

III. RESULTS AND DISCUSSION

The XRD results obtained for Al₂O₃ nanoparticles with co-precipitation method is shown in Fig. 3. Two peaks are at 2θ=47 and 2θ=67-68 observed. The first peak relates to sodium oxide (Na₂O). Because most of sodium was washed during synthesizing alumina its peak was rather weak. The second peak related to γ-Al₂O₃.

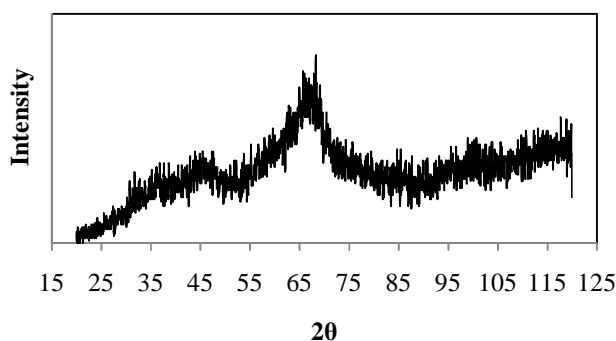

Fig. 3 Experimental powder X-ray diffraction patterns for alumina nanoparticles with co-precipitation method

Fig. 4 showed the XRD results obtained for Al_2O_3 nanoparticles utilizing wet chemical method. A weak broad peak at $2\theta=67-68$ indicated amorphous $\gamma-Al_2O_3$ nanoparticles. Fig. 5 showed SEM micrographs of $\gamma-Al_2O_3$ nanoparticles prepared through wet chemical method. It might be observed that the prepared particles were spherical, smooth, non-aggregated and relatively uniform in size (<100 nm).

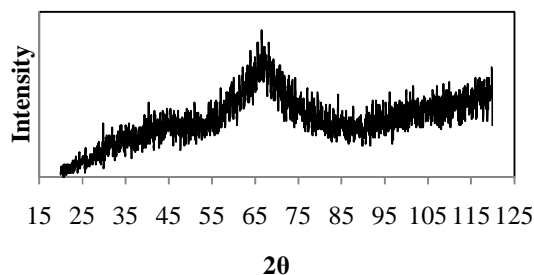

Fig. 4 Experimental powder X-ray diffraction patterns for alumina nanoparticles with wet chemical method

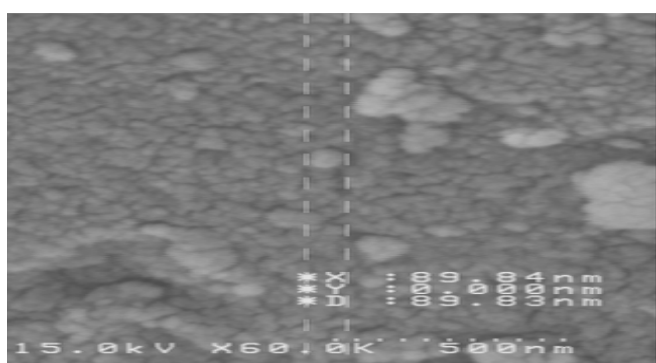

Fig. 5 SEM micrograph for alumina nanoparticles prepared with wet chemical method

Fig. 6, showed the XRD pattern of the best sample of Al_2O_3 nanoparticles with spray pyrolysis method possessing the highest BET surface area. A weak peak at $2\theta=47$ indicated the existence of sodium oxide and the next peak at $2\theta=67-68$ related to $\gamma-Al_2O_3$.

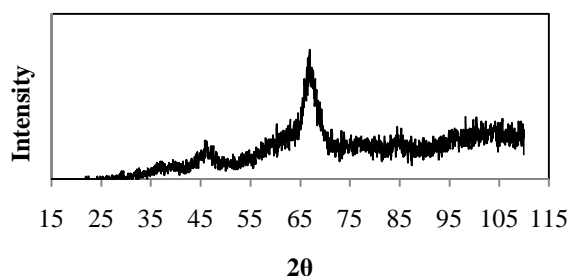

Fig. 6 Experimental powder X-ray diffraction pattern for alumina nanoparticles with spray pyrolysis method

A. Initial screening of the space parameter for synthesizing of Al_2O_3 nanoparticles with spray pyrolysis method employing Box-Behnken design

Efficient response resulting in the maximum BET surface area required the early identification of key process parameters. Based upon the literature [5-9] with the spray pyrolysis method the following process variables for the optimization were considered: (i) concentration, (ii) temperature and (iii) rate. These were varied in range of 0.05-0.15mol/l, 500-650⁰C and 70-150 ml/min; respectively. The Box-Behnken design may find the influences of each process variable as a variety of others' levels as well as; the interactions amongst these variables on the synthesis of alumina nanoparticles. Three level designs with 3 key variables were developed. Therefore, the total runs were limited to 14. Effects of the following process variables on the synthesis of alumina nanoparticles were investigated in the aforementioned design study: the (A) temperature; (B) concentration and (C) rate. Fixed levels of these three variables provided in Table 1. The analysis of variance (*i.e.*, ANOVA) on the synthesis of alumina nanoparticles were summarized in Table 2. The F-test statistic defined as $F = MSF/MSE$, where MSF and MSE were the mean squares of factors or interactions and errors; respectively. If the calculated value of F was greater than the value in the F-Table at a specified probability level, a statistically significant factor or interaction was determined. From a combination of estimates for the process variables and the ANOVA results, a linear model with statistical significance might be generated. This model, quantitatively elucidating the effects of process variables with statistical significance and presented as follows:

$$\text{Surface area} = -2142.53 + 4.23 * A - 17.93 * A * B - 0.02 * A * C \quad (3)$$

The multiple correlation coefficient squared, $R^2 = 1 - (SSE/SST)$, equaled to 0.99 for Equation (3), indicated a very good fitting for the experimental data of surface area on factors A, B and C. Result revealed that, the BET surface area of alumina nanoparticles increased by enhanced reaction temperatures. In other words, by increasing the reaction temperature the rate of reaction increased, hence the reaction between the two solutions took place more efficiently. Thus,

the BET surface area of alumina nanoparticles increased. This BET specific area of alumina nanoparticles was also increased by lowering the concentration. In other words, by decreased concentration, the reaction between the two solutions occurred at microscopic level. Nonetheless, at higher concentrations a lump of each solutions reacted and possibly agglomeration happened. Ultimately, the increased BET area of alumina nanoparticles occurred by decreasing rate because the residence time enhanced and while the reaction between solutions were more highly pronounced, the BET surface area of alumina nanoparticles also raised.

TABLE I
FACTORS AND LEVELS FOR THE 3-LEVEL BOX-BEHNKEN DESIGN

Factor	Variable	Level		
A	Temperature(°C)	500	575	650
B	Concentration(mole/l)	0.2	0.9	1.6
C	Rate(ml/min)	70	110	150

TABLE II
ANALYSIS OF VARIANCE FOR THE SYNTHESIS OF ALUMINA NANOPARTICLE FROM THE EXPERIMENTAL DESIGN

Factor	Df	SS	MS	F
A	1	21424.5	21424.5	13.77
B	1	5151.13	5151.13	3.31
C	1	3828.12	3828.12	2.46
AB	1	18090.25	18090.25	11.63
AC	1	9120.25	9120.25	5.86
BC	1	256	256	0.16
Error		12.5		
Total		68762.36		

B. Comparison between the commercial Claus catalyst and synthesized nanocatalysts

Alumina based Claus catalyst (CR-3S) and Titania based Claus catalyst (CRS-31) tested in H₂S oxidation setup (Fig. 2) at Claus operating conditions [9, 10]. Specifications of Claus catalysts provided in Tables 3 and 4. Experiments performed at temperature of 250°C, pressure of 1atm, 12-14 mesh size of catalyst (1.3mm), GHSV=5500h⁻¹, O₂/H₂S=0.5 and 6.6% H₂S in the feed stream. In addition, synthesized nanoparticles tested and fractional conversions calculated for each one. Instantaneous fractional conversion of H₂S defined as follows:

$$\text{conversion of } H_2S (\%) = \frac{[H_2S]_{in} - [H_2S]_{out}}{[H_2S]_{in}} \times 100 \quad (4)$$

And H₂S concentration calculated from the following utilizing a Mettler potentiometer with detection threshold of 0.5 ppm:

$$\text{ppm } H_2S = \frac{16000 \times N_{Ag^+} \times V_{Ag^+}}{M} \quad (5)$$

where N_{Ag⁺} is normality of AgNO₃ solution, V_{Ag⁺} is the volume consumed and M is molecular weight of gas sample.

Steady state conversion as seen from Fig. 7 obtained after 6h for nanoparticles prepared in this research. It was observed that amongst materials prepared in this research; alumina nanoparticles prepared with wet chemical and spray pyrolysis methods had higher activities and resulted in higher conversions than the commercial Claus catalyst. Because the reaction between H₂S and O₂ is irreversible, no thermodynamic restrictions existed hence, conversions higher than 95-97% might be achieved. In addition, from the ASAP analysis (see Table 5) one may see that alumina nanoparticles in the wet chemical and spray pyrolysis method have a higher BET surface area and total pore volume than other synthesized materials, thus, resulted in higher conversion than even the commercial Claus catalyst. Pore size distributions (PSD) were measured for fresh alumina nanoparticles with wet chemical method (See Fig. 8). The original pore size shown in the fresh alumina is 1.66nm which indicated micro-pore. It is known that micropores have higher surface area and capillary action than mesopores and macropores, thus, reactions between reactant and surface of catalyst is stronger and more hydrogen sulfide might be converted into elemental sulfur. Furthermore, the total sulfur analysis for the Claus conventional catalyst and synthesized nanocatalyst after reaction at 250°C, GHSV = 5500h⁻¹, O₂/H₂S=0.5 and 6.6% H₂S in the feed stream shown in Table 6. It is seen that synthesized nanocatalyst had more sulfur adsorbed on its surface. In industry, removal of H₂S and converting it into sulfur is done either by the thermal or catalytic technique including 3-5 steps. Whereas, system with catalysts developed in this research included one fixed bed reactor which adsorbed more H₂S on the surface of the catalyst, hence higher conversion into elemental sulfur and other products resulted.

TABLE III
CR-3S CLAUS CATALYST SPECIFICATIONS

Physical Properties		
	Unit	Typical Value
Bulk Density	kg/m ³	660
Surface Area (BET)	m ² /g	320
Porosity (Macroporosity)	ml/g	0.2
Chemical Analysis		
Al ₂ O ₃	%	>93.8
Na ₂ O	ppm	2000

TABLE IV
CRS-31 CLAUS CATALYST SPECIFICATIONS

Physical Properties		
	Unit	Typical Value
Bulk Density	kg/m ³	1000
Surface Area (BET)	m ² /g	130
Chemical Analysis		
TiO ₂	%	>85

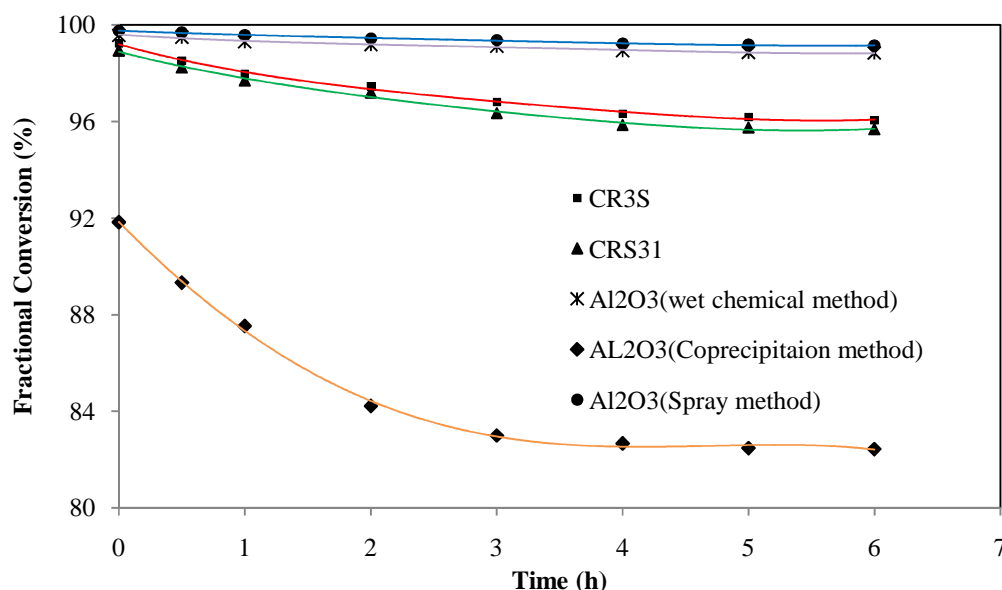

Fig. 7 Comparison of fractional conversion of H₂S to elemental sulfur over synthesized nanocatalyst and commercial Claus catalyst

TABLE V
ASAP ANALYSIS OF SYNTHESIZED NANOPARTICLES

Sample	A _s (BET) (m ² /g)	Total pore Volume (cm ³ /g)	Mean pore diameter(nm)	R _{p,peak} (Area) (nm)
Al ₂ O ₃ (Wet Chemical)	278.24	0.7174	10.313	1.66
Al ₂ O ₃ (spray method)	395	0.7415	11.52	1.62

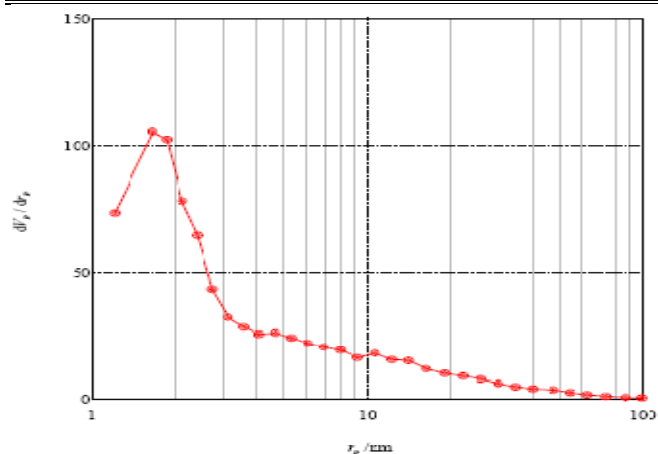

Fig. 8 Pore size distributions for alumina nanoparticles prepared with wet chemical method

TABLE VI
TOTAL SULFUR ANALYSIS OF CLAUS COMMERCIAL CATALYST AND ALUMINA SYNTHESIZED NANOPARTICLES WITH WET CHEMICAL METHOD IN THIS WORK

Sample name	Weight percent of sulfur on surface of catalyst (%)
Commercial catalyst	3.02
Alumina nanoparticles synthesized with wet chemical method	5.94

IV. CONCLUSIONS

Reactor test results as well as; the porosimetric properties of materials under study, made it clear that larger pore volumes and more surface areas were desired for obtaining more resistant catalyst towards deactivation. In these cases cobalt clusters might have presented themselves better to the reaction media hence the determined activity and selectivity outcomes were improved. In addition, It is a foregone conclusion that the first calcination made the highest impact on catalyst deactivation while stepwise decrease in the porosimetric properties of the catalyst through further calcinations with more moderate yet still negative slopes was observed. This meant that for the final catalyst to be more active and selective (*i.e.*; needed more surface area and pore volume) fewer number of calcinations preferred. Ultimately, adsorption isotherms indicated that calcination just reduced the pore volume and the extent of adsorption by blocking some pores. Nonetheless, calcinations didn't change the shape of adsorption isotherms in order to change its type, hence deactivation behavior.

REFERENCES

- [1] Kirk-Othmer, Encyclopedia of chemical technology, vol. 22, 3rd Ed, Wiley/Interscience: New York, 1983, p. 276.
- [2] M.-II Kim, W.-D. Ju, K.-H. Kim, D.-W. Park, and S.-S. Hong, "Selective oxidation of hydrogen sulfide to elemental sulfur and ammonium thiosulfate using VO_x/TiO₂ catalysts," *Stud. Surf. Sci. Catal.*, vol. 159, pp. 225-228, 2006.
- [3] S. W. Chun, J. Y. Jang, D. W. Park, H. C. Woo, and J. S. Chung, "Selective oxidation of H₂S to elemental sulfur over TiO₂/SiO₂ catalysts," *Appl. Catal., B*, vol. 16, pp. 235-243, 1998.
- [4] S. Yasyerli, G. Dogu, and T. Dogu, "Selective oxidation of H₂S to elemental sulfur over Ce-V mixed oxide and CeO₂ catalysts prepared by the complexation technique," *Catal. Today*, vol. 117, pp. 271-278, 2006.
- [5] J. H. Kim, K. Y. Jung, K. Y. Park, and S. B. Cho, "Characterization of mesoporous alumina particles prepared by spray pyrolysis of Al(NO₃)₃·9H₂O precursor: Effect of CTAB and urea," *Microporous Mesoporous Mater.*, vol. 128, pp. 85-90, 2010.

- [6] T. Novakovic, N. Radic, B. Grbic, V. Dondur, M. Mitric, D. Randjelovic, D. Stoychev, and P. Stefanov, "The thermal stability of porous alumina/stainless steel catalyst support obtained by spray Pyrolysis," *Appl. Surf. Sci.*, vol. 255, pp. 3049-3055, 2008.
- [7] G. P. Kalignan, D. J. Seo, and S. B. Park, "Characterization of Sr β -alumina prepared by sol-gel and spray pyrolysis methods," *Mater. Chem. Phys.*, vol. 85, pp. 286-293, 2004.
- [8] M. R. Zachariah, and B. Y.H. Liu, "Synthesis of nanoporous particles," U.S. Patent No. 7276224 B2, 2007.
- [9] O. I. Platonov, and L. S. Tsemekhman, "Gas composition effect on the Klaus process efficiency", *Russ. J. Appl. Chem.*, vol. 82, pp. 1314-1316, 2009.
- [10] P. D. Clark, N. I. Dowling, M. Huang, O. Okemona, G. D. Butlin, R. Hou, and W. S. Kijlstra, "Studies on sulfate formation during the conversion of H₂S and SO₂ to sulfur over activated alumina," *Appl. Catal., A*, vol. 235, pp. 61-69, 2002.