

Image Compression Using Multiwavelet and Multi-stage Vector Quantization

S. Esakkirajan, T. Veerakumar, V. Senthil Murugan, P. Navaneethan

Abstract—The existing image coding standards generally degrades at low bit-rates because of the underlying block based Discrete Cosine Transform scheme. Over the past decade, the success of wavelets in solving many different problems has contributed to its unprecedented popularity. Due to implementation constraints scalar wavelets do not possess all the properties such as orthogonality, short support, linear phase symmetry, and a high order of approximation through vanishing moments simultaneously, which are very much essential for signal processing. New class of wavelets called ‘Multiwavelets’ which possess more than one scaling function overcomes this problem. This paper presents a new image coding scheme based on non linear approximation of multiwavelet coefficients along with multistage vector quantization. The performance of the proposed scheme is compared with the results obtained from scalar wavelets.

Keywords—Image compression, Multiwavelets, Multi-stage vector quantization.

I. INTRODUCTION

DIGITAL representation of image has created the need for efficient compression algorithms that will reduce the storage space and the associated channel bandwidth for the transmission of images. Wavelet transforms have become more and more popular in the last decade in the field of image compression. They have an advantage over the block-based transforms such as Discrete Cosine Transform (DCT) [1] which exhibits blocking artifact. Wavelets with compact support provide a versatile alternative to DCT. The groundbreaking single-wavelet examples [2] provided multiresolution function-approximation bases formed by translations and dilations of a single approximation functions and detail functions. In the last years multiwavelets, which consist of more than one wavelet have attracted many researchers [3], [4]. Certain properties of wavelets such as orthogonality, compact support, linear phase, and high

approximation/vanishing moments of the basis function, are found to be useful in image compression applications. Unfortunately, the wavelets can never possess all the above mentioned properties simultaneously [2]. To overcome these drawbacks, more than one scaling function and mother wavelet function need to be used. Multiwavelets possess more than one scaling function offer the possibility of superior performance and high degree of freedom for image processing applications, compared with scalar wavelets. Multiwavelets can achieve better level of performance than scalar wavelets with similar computational complexity. In the case of nonlinear approximation with multiwavelet basis, the multiwavelet coefficients are effectively “reordered” according to how significant they are in reducing the approximation error.

Vector quantization has proven to be a very powerful technique in low bit-rate image coding due to its inherent theoretical superiority over scalar quantization [5]. The applicability of Vector Quantization (VQ) is limited by an exponential growth of the computational complexity with the vector dimension. For this reason, low-dimensionality vector quantizers are typically used in image compression, but such vector quantizers limit the coding efficiency and tend to yield highly visible block boundaries in low bit rate applications. Multistage codebook makes it possible to implement high-dimensional vector quantizers with relatively low complexity. Multistage Vector Quantization (MSVQ) is a structured VQ scheme in which substantial complexity (search time and codebook storage) reduction with respect to optimal VQ is obtainable [6]. In this paper, we propose a new image compression scheme for gray scale image compression using successive approximation quantization of vectors of the multiwavelet transformed image.

This paper is organized as follows: Section II deals with the concept of multiwavelet and multiwavelet filter banks. Section III deals with the concept of non-linear approximation where the multiwavelet coefficients are reordered, the significant transform coefficients of the image are retained and set the rest to zero. Section IV gives brief introduction to MSVQ. The proposed algorithm is discussed in section V. Results and discussion are presented in section VI and finally conclusions are drawn in the section VII.

II. MULTI WAVELETS

Manuscript received August, 2007.

S. Esakkirajan is working as a Lecturer, in the Department of Instrumentation and Control Systems Engineering, PSG College of Technology, Coimbatore, India. (Corresponding author to provide phone: 91-422-2572177; E-mail: rajanesakki@yahoo.com).

T. Veerakumar is working as a Lecturer, in the Department of Electronics and Communication Engineering, PSG College of Technology, Coimbatore, India. (E-mail: tveerakumar@yahoo.co.in).

V. Senthil Murugan is with Mahindra and Mahindra, India (E-mail: senthilmurugan_eee@yahoo.co.in).

Dr. P. Navaneethan is working as a Professor, in the Department of Electrical and Electronics Engineering, PSG College of Technology, Coimbatore, India.

The wavelet transform is a type of signal transform that is commonly used in image compression. Because of their energy compaction properties and correspondence with the human visual system, wavelet representations have produced superior objective and subjective results in image compression. Since a wavelet basis consists of functions with short support for high frequencies and long support for low frequencies, large smooth areas of an image may be represented with few bits, which is vital for image compression. Multiwavelet offers all of these traditional advantages of wavelets, as well as the combination of orthogonality, symmetry and linear phase properties simultaneously. The short support of multiwavelets filters limits ringing artifacts due to subsequent quantization. Symmetry of the filter bank not only leads to efficient boundary handling, it also preserves centers of mass, lessening the blurring of fine-scale features. Orthogonality is useful because it means that rate-distortion optimal quantization strategies may be employed in the transform domain and still lead to optimal time-domain quantization, at least when error is measured in a mean-square sense. Thus it is natural to consider the use of multiwavelets in a transform based image coder.

Multiwavelets are very similar to wavelets but have some important differences. Wavelets are associated with one scaling function $\Phi(t)$ and a wavelet function $\Psi(t)$, whereas multiwavelets have two or more scaling and wavelet functions. The multiscaling function is given by equation (1)

$$\Phi(t) = [\phi_1(t), \phi_2(t), \dots, \phi_r(t)]^T \quad (1)$$

Similarly the multiwavelet function is given by equation (2)

$$\Psi(t) = [\psi_1(t), \psi_2(t), \dots, \psi_r(t)]^T \quad (2)$$

When $r = 1$, is called a scalar wavelet or simply wavelet. While in principle 'r' can be arbitrarily large, the multiwavelets are analyzed primarily for $r = 2$.

The multiwavelet two-scale relationship are given by equation (3) and equation (4)

$$\Phi(t) = \sqrt{2} \sum_{k=-\infty}^{\infty} H_k \Phi(2t - k) \quad (3)$$

$$\Psi(t) = \sqrt{2} \sum_{k=-\infty}^{\infty} G_k \Phi(2t - k) \quad (4)$$

Where $\{H_k\}$ and $\{G_k\}$ are matrix filters defined as

$$H_k = \begin{bmatrix} h_0(2k) & h_0(2k+1) \\ h_1(2k) & h_1(2k+1) \end{bmatrix} \quad (5)$$

such that $\sum_k h_0(k)^2 = 1$ and $\sum_k h_1(k)^2 = 1$

$$G_k = \begin{bmatrix} g_0(2k) & g_0(2k+1) \\ g_1(2k) & g_1(2k+1) \end{bmatrix} \quad (6)$$

such that $\sum_k g_0(k)^2 = 1$ and $\sum_k g_1(k)^2 = 1$.

The matrix elements provide more degrees of freedom than a traditional scalar wavelet. These extra degrees of freedom

can be used to incorporate useful properties into the multiwavelet filters, such as orthogonality, symmetry, and high order of approximation. The multiwavelet transform is implemented through a filter bank structure [7].

The multiwavelet decomposition of 'Barbara' image is shown in Fig. 1. Unlike scalar wavelets, in which Mallat's pyramid algorithms [8] can be employed directly, the application of multiwavelets requires that the input signal first be vectorised namely preprocessing, this is popularly known as multiwavelet initialization or prefiltering [9]. In this paper, the preprocessing is based on Strela's algorithms [4], [10].

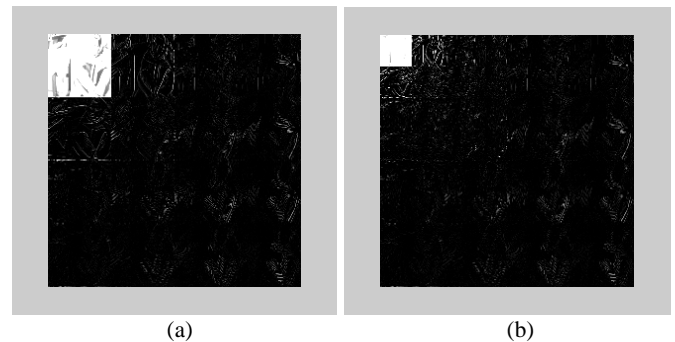

Fig. 1 (a) First Level (b) Second Level multiwavelet decomposition of Barbara image

A preprocessing scheme is described based on the approximation properties of the multiwavelets which yield a critically sampled image each of size $(MXN)/4$. Another advantage of this preprocessing is that it fits naturally with symmetric extension to multiwavelets.

III. NON-LINEAR APPROXIMATION

Recent activity in image processing has resulted in an important shift in the way linear image representations are designed and exploited. Given a basis and image representation in terms of this basis, linear approximation based techniques insist on viewing this representation in terms of a specific order, namely the order determined by the a priori ordering of the basis functions. Nonlinear approximation [11] based techniques on the other hand have no a priori order of preferences, and they have the capability to utilize different orderings depending on the signal application. Let $X(N-1)$ be an 'N' dimensional signal and assume that we are given a linear, invertible transform. Let $h_i(N-1)$, $i=1, \dots, N$ denote the reconstruction basis, and let c_i , $i=1, 2, \dots, N$, denote the corresponding transform coefficients of X . We have

$$X = \sum_{i=1}^N c_i h_i \quad (7)$$

The distinction between the two approaches manifests itself when we consider approximations \hat{X}_{linear} and of X with a limited number, say $K < N$, of transform coefficients. The two types of approximations can be written as

$$\hat{X}_{linear}(K) = \sum_{i=1}^N c_i h_i \quad (8)$$

$$\hat{X}_{nonlinear}(K) = \sum_{i \in \xi(x)} c_i h_i \quad (9)$$

where the cardinality of the index set $\xi(x)$ in (9) is $\text{card}(\xi(x)) = K$, and the notation indicates the dependence of the index set on the signal. It is evident that linear approximation becomes one particular form of nonlinear approximation if $\text{set } \xi(x) = \{1, \dots, K\}$, however, nonlinear approximation becomes much more advantageous when we follow for the optimal choice of $\xi(x)$ that minimizes the mean squared approximation error for each 'x'. For orthonormal transforms, the optimal can be constructed as the indices of the 'K' largest magnitude transform coefficients of 'X'.

We have performed non-linear approximation of multiwavelet coefficients and compared our results with non-linear approximation of wavelet based ones. In the case of nonlinear approximation with a multiwavelet basis, the multiwavelet coefficients are effectively "reordered" according to how significant they are in reducing the approximation error. Hence, for a given number of retained multiwavelet coefficients in nonlinear approximation, there is a need to evaluate the number of bits necessary to encode the "addressing" of these coefficients, i.e., the number of bits necessary to convey which coefficients have been retained. Our PSNR results indicate that nonlinear approximation of multiwavelet coefficients performs better than the wavelet based ones.

IV. MULTI-STAGE VECTOR QUANTIZATION

Vector quantization is a powerful tool for data compression. Vector quantization extends scalar quantization to higher dimensional space. By grouping input samples into vectors and using a vector quantizer, a lower bit rate and higher performance can be achieved. However, the codebook size and the computational complexity increase exponentially as the rate increases for a given vector size. Full-search VQ such as entropy-constrained VQ (ECVQ) enjoys small quantization distortion. However, it has long compression time, and may not be well suited for real time signal compression systems. Tree-structured VQ (TSVQ) although can significantly reduce the compression time, has the disadvantage that the storage size required for the VQ is usually very large and cannot be controlled during the design process. Therefore, it may not be convenient to use TSVQ for the applications where the storage size is a major concern.

A structured VQ scheme which can achieve very low encoding and storage complexity is MSVQ [12]. This appealing property of MSVQ motivated us to use MSVQ in the quantization stage. The basic idea of multistage vector quantization is to divide the encoding task into successive stages, where the first stage performs a relatively crude quantization of the input vector. Then a second-stage

quantizer operates on the error vector between the original and the quantized first-stage output. The quantized error vector then provides a second approximation to the original input vector thereby leading to a refined or more accurate representation of the input. A third stage quantizer may then be used to quantize the second-stage error to provide a further refinement and so on.

In this paper, we have implemented two-stage vector quantizer. The input vector is quantized by the initial or first-stage vector quantizer denoted by VQ1 whose code book is $C_1 = \{c_{10}, c_{11}, \dots, c_{1(N_1-1)}\}$ with size N_1 . The quantized approximation \hat{x}_1 is then subtracted from x producing the error vector. This error vector is then applied to a second vector quantizer VQ2 whose code book is $C_2 = \{c_{20}, c_{21}, \dots, c_{2(N_2-1)}\}$ with size N_2 yielding the quantized output.

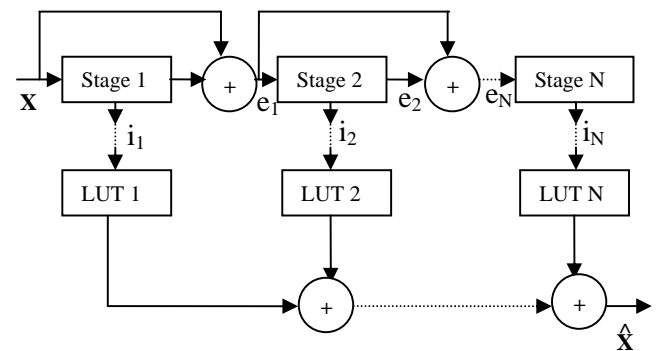

Fig. 2 Multistage Vector Quantization System

The encoder transmits a pair of indices specifying the selected codeword for each stage and the task of the decoder is to perform two table lookups to generate and then sum the two code words. In fact, the overall codeword or index is the concatenation of code words or indices chosen from each of two codebooks. Thus, the equivalent product codebook can be generated from the Cartesian product $C_1 \times C_2$. Compared to the full-search VQ with the product codebook C , the two stage VQ can reduce the complexity from $N = N_1 \times N_2$ to $N_1 + N_2$. The multistage vector quantization system for 'N' stages is shown in Fig. 2. In the figure, 'X' represents the input vector, LUT stands for lookup table and i_1, i_2 , etc represent indices from different stages. The overall index is the concatenation of indices chosen from each of the two codebooks. From the Fig. 2, it is evident that the input vector is given only to the first stage, whereas the input to the successive stages is the error vectors from the previous stage which are denoted by e_1, e_2, \dots, e_N . \hat{X} is the reconstructed signal at the decoder end.

V. PROPOSED ALGORITHM

The proposed image coder scheme is explained below.

1. The correlation present in the input image is removed by taking multiwavelet transform of the input image.
2. The non-linear approximation of the multiwavelet coefficients is performed.
3. The transform coefficients obtained in step 2 are vector quantized in a multistage manner where the residual error coefficients due to quantization are iteratively feedback and vector quantized. If the number of stages in MSVQ is more, the refinement of the quantized vectors will be better. But it suffers from the need for a high bit-rate for each additional stage is added. Hence we have restricted our attention to two stages in Multistage Vector Quantization.
4. The outputs from step 3 are lossless coded using static Huffman code. This completes the encoder stage of the proposed algorithm which is illustrated in Fig. 3. In decoding, the decoder basically performs the reverse process of the above steps.

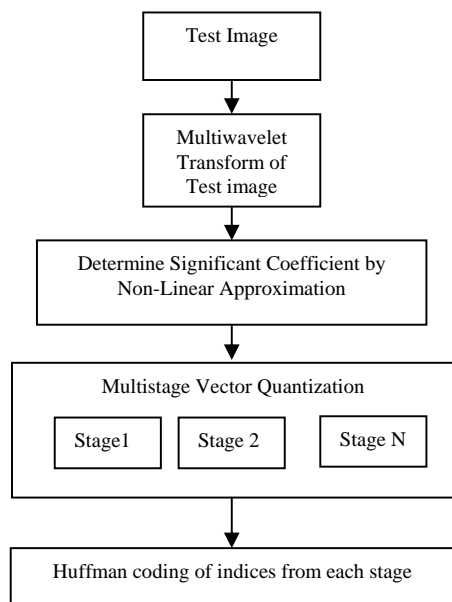

Fig. 3 Encoder of the proposed algorithm

VI. RESULTS AND DISCUSSIONS

We present the encoding results for 256 X 256, 8 bit resolution 'Lena', 'Barbara' and 'Boat' images [13]. 'Lena' is class of natural image that do not contain large amounts of high-frequency or oscillating patterns. 'Barbara' image exhibits large amounts of high-frequency and oscillating patterns. 'Boat' image contains significant amounts of both low and high-frequency region. The images are decomposed using multiwavelet transform. The multifilters used in this experiment are CL, SA4, GHM, and CARDBAL2. The pre-filter and post filter chosen are CLAP, SA4AP, GHMAP, ID respectively. The encoded multiwavelet coefficients are subjected to non-linear approximation and the resultant

coefficients are coded by multistage vector quantization. The results are compared with that of scalar wavelets in the same way. Table I, II and III shows the comparative results of 'Lena', 'Barbara' and 'Boat' images using 'CL' as multifilter and 'HAAR' as scalar filter. From these tables the following conclusions can be drawn

- (1) When the percentage of the significant coefficient retained is less, multiwavelet is giving better PSNR when compared to scalar wavelets.
- (2) As the level of decomposition increases, the performance of scalar wavelet matches with that of multiwavelet.
- (3) As the bit rate increases, the PSNR value increases which is in accordance with Rate-Distortion theory.

Figure 4 shows the plot of PSNR against the percentage of coefficients retained for multiwavelets and wavelets with rate as two, under second level of decomposition. When the NLA coefficients retained is less the gap between the performance of multiwavelet and scalar wavelet is more and it merges with the increase in NLA coefficients. This is completely evident from the Fig. 4.

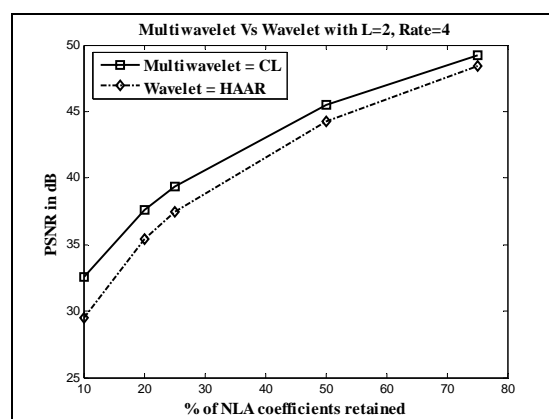

Fig. 4 Comparison of PSNR values for multiwavelets and wavelets for 'Lena' image

Figure 5 shows the original and the reconstructed 'Lena' image using multiwavelet transform and wavelet transform with 10% of the coefficients retained with first level of decomposition and rate as four. From the Fig. 5b and 5c, it is obvious the visual quality of the reconstructed image using multiwavelet transform is better than that of wavelet transform.

Figure 6 shows the original and reconstructed 'Barbara' image using wavelet and multiwavelet transform with 25% of the significant coefficient retained for the first level of decomposition and the selected rate is four. The original and the reconstructed 'Boat' image using multiwavelet transform and wavelet transform are shown in Fig. 7.

We have used our algorithm to compare the performance of different multifilters against different wavelets like 'HAAR', 'LA8', 'BI9/7' for 'Lena' image with 25% NLA coefficients retained, and the results are tabulated in table IV.

Figure 8, shows the plot of PSNR against the significant rate as eight under second level of decomposition. From the

TABLE I
 PSNR RESULTS FOR 'LENA' IMAGE

Level of decomposition	Multiwavelet (PSNR in dB)				Wavelet (PSNR in dB)				
	Bit rate NLA %	1	2	4	8	1	2	4	8
1	10	23.27	29.27	30.14	30.21	11.81	10.76	10.51	10.45
	20	24.71	33.81	36.57	36.83	20.56	19.94	19.29	19.44
	25	25.00	34.93	38.63	39.02	23.05	27.56	28.05	28.02
	50	25.67	37.40	45.42	47.21	25.32	36.51	43.26	44.47
	75	25.92	38.46	49.63	56.25	25.77	38.23	48.79	54.23
2	10	23.43	31.02	32.59	32.71	22.19	28.44	29.48	29.57
	20	24.22	34.14	37.60	37.95	23.23	32.48	35.42	35.72
	25	24.43	34.98	39.68	39.89	23.53	33.55	37.44	37.89
	50	24.96	37.00	45.51	47.64	24.29	36.11	44.29	46.26
	75	25.17	37.90	49.20	56.37	24.59	37.37	48.41	55.08
3	10	23.24	31.20	32.84	32.98	22.11	29.67	31.24	31.38
	20	23.92	34.13	37.68	38.08	22.91	32.65	36.08	36.44
	25	24.11	34.94	39.43	39.99	23.16	33.53	37.86	38.39
	50	24.58	36.86	45.38	47.66	23.84	35.88	44.28	46.44
	75	24.77	37.71	48.83	56.25	24.10	37.04	48.11	55.00

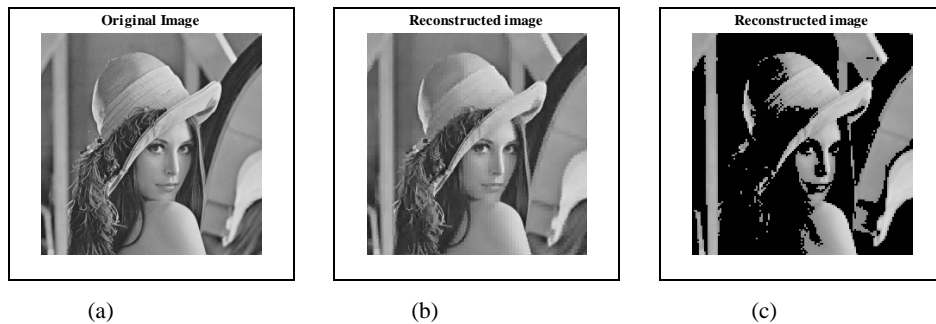

Fig. 5 (a) Original image (b) Reconstructed image using multiwavelet transform (c) Reconstructed image using scalar wavelet

TABLE II
 PSNR RESULTS FOR 'BARBARA' IMAGE

Level of decomposition	Multiwavelet (PSNR in dB)				Wavelet (PSNR in dB)				
	Bit rate NLA %	1	2	4	8	1	2	4	8
1	10	21.60	25.06	25.39	25.41	12.53	11.46	11.20	11.14
	20	23.28	29.79	30.80	30.87	18.41	20.11	19.84	19.76
	25	23.71	31.46	33.01	33.12	22.20	24.12	24.16	24.13
	50	24.97	35.98	42.09	43.03	25.89	35.72	38.93	39.23
	75	25.48	37.88	48.33	53.23	26.65	38.72	48.27	51.48
2	10	21.73	26.71	27.32	27.36	21.22	24.41	24.70	24.72
	20	22.84	30.41	31.92	32.04	23.09	29.02	29.83	29.87
	25	23.23	31.81	33.95	34.13	23.61	30.77	32.01	32.09
	50	24.37	35.61	42.34	43.49	24.92	35.86	41.30	42.04
	75	24.82	37.29	47.94	53.35	25.42	37.77	47.97	52.26
3	10	21.65	26.84	27.51	27.56	21.66	25.73	26.15	26.17
	20	22.71	30.42	32.01	32.15	23.02	29.56	30.58	30.64
	25	23.10	32.79	34.02	34.22	23.47	31.18	32.62	32.72
	50	24.17	35.47	42.26	43.50	24.66	35.66	41.40	42.22
	75	24.60	37.09	47.64	53.33	25.13	37.45	47.84	52.62

coefficients retained for multiwavelets and wavelets with the figure it is evident that, when the percentage of significant

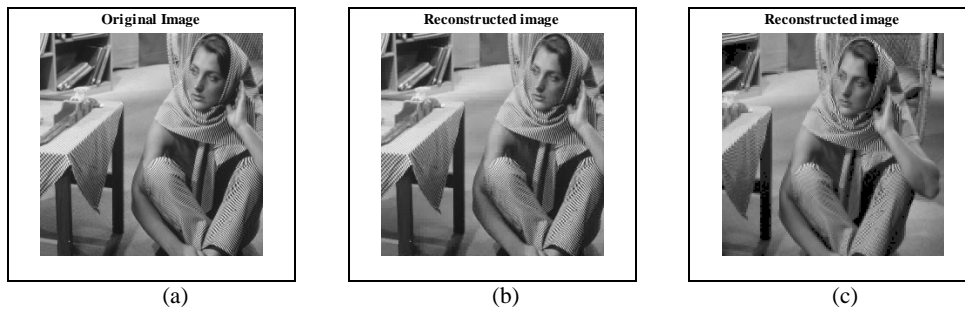

Fig. 6 (a) Original image (b) Reconstructed image using multiwavelet transform (c) Reconstructed image using scalar wavelet

TABLE III
 PSNR RESULTS FOR 'BOAT' IMAGE

Level of decomposition	Multiwavelet (PSNR in dB)				Wavelet (PSNR in dB)				
	Bit rate	1	2	4	8	1	2	4	8
1	NLA %								
	10	23.91	29.24	30.14	30.19	10.31	9.43	9.22	9.17
	20	25.11	33.86	36.29	36.49	20.44	19.40	19.08	18.99
	25	25.41	35.05	38.48	38.82	24.68	29.09	29.44	29.42
	50	26.12	37.85	46.49	48.78	26.66	38.19	4.21	49.89
2	75	26.32	38.74	50.32	58.51	26.86	38.96	50.60	59.98
	10	23.84	30.95	32.32	32.41	23.38	29.13	29.95	30.00
	20	24.65	34.11	37.22	37.51	24.50	33.71	36.58	36.83
	25	24.90	35.10	39.19	39.64	24.79	34.96	39.12	39.58
	50	25.49	37.85	46.49	48.78	25.43	37.47	47.80	52.27
3	75	25.67	38.13	49.80	58.42	25.55	38.01	50.03	61.05
	10	23.74	31.00	32.44	32.55	23.30	30.37	31.68	31.78
	20	24.49	34.00	37.24	37.54	24.19	33.80	37.21	37.55
	25	24.71	34.93	39.19	39.66	24.45	34.87	39.59	40.16
	50	25.24	37.01	46.37	49.12	25.04	37.18	47.73	52.80
	75	25.40	37.67	49.52	48.78	25.16	37.66	49.67	60.83

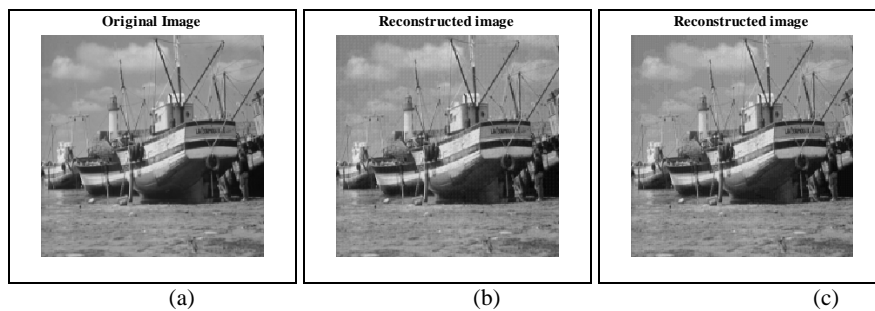

Fig. 7 (a) Original image (b) Reconstructed image using multiwavelet transform (c) Reconstructed image using scalar wavelet

TABLE IV
 RESULTS OF THE MSVQ SCHEME FOR LENA IMAGE

Rate	Multiwavelet (PSNR in dB)				Wavelet (PSNR in dB)		
	CL	SA4	GHM	CARDB AL2	HAAR	LA8	BI9/7
1	25.00	24.80	23.12	24.19	23.05	23.02	23.03
2	34.93	34.95	28.23	29.28	27.56	29.24	29.35
4	38.63	38.90	28.41	29.63	28.05	29.79	29.66
8	39.02	39.30	28.70	29.65	28.02	29.81	29.91

coefficient retained is less than twenty percent, the performance of multiwavelet is better than scalar wavelet, at around thirty percent of retained coefficients, both multiwavelets and wavelets are performing equally well beyond that wavelets dominates multiwavelets.

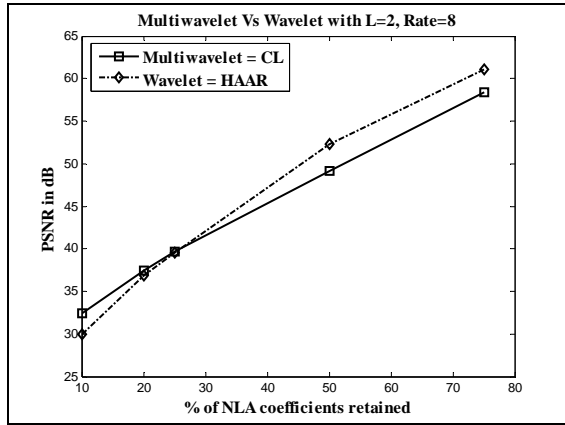

Fig. 8 Comparison of Multiwavelets against wavelets for 'Boat' image

Figure 9 shows the performance of multiwavelets tested for different images under third level of decomposition with twenty percentages of NLA coefficients retained, from the figure, it is evident that PSNR obtained in the case of 'Lena', 'Boat' is better than that of 'Barbara' image.

From this we can conclude that the proposed scheme works well for low frequency images than high frequency image, under the same amount of NLA coefficients retained.

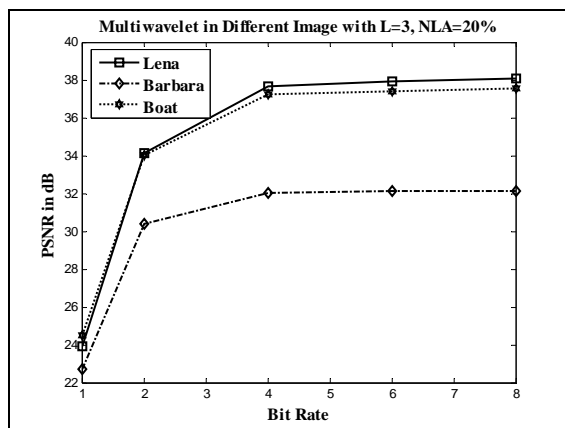

Fig. 9 Comparative performances of multiwavelets for different images

VII. CONCLUSION

In this work we have proposed a new image coding algorithm based on non-linear approximation of multiwavelet transform along with multistage VQ. Our aim is to compare the performance of multiwavelets against scalar wavelets on different images along with the application of multistage

vector quantization on both the schemes. When the number of significant coefficients is less than fifty percent, the performance of multiwavelet dominates wavelets irrespective of images chosen. This implies that, few significant multiwavelet coefficients are sufficient to reconstruct the image in a better manner than with the same significant wavelet coefficients. If we allow more significant coefficients, the performance of scalar wavelets dominates the performance of multiwavelets. This proves that multiwavelet cannot always substitute scalar wavelets with respect to image compression even though multiwavelets offer the advantages of combining symmetry, orthogonality, and short support, properties not mutually achievable with scalar two-band wavelet systems.

ACKNOWLEDGMENT

The authors wish to thank their teachers Dr. S. Jayaraman, Dr. N. Malmurugan, and Mr. R. Sudhakar for their continued support and encouragement. They also thank their present institution where they are working.

REFERENCES

- [1] K. R. Rao, and Yip, "Discrete Cosine Transform: Algorithms, Advantages, Applications," Academic Press, 1990.
- [2] I. Daubechies, "Ten Lectures on Wavelets", Philadelphia, PA:SIAM, 1992.
- [3] X. G. Xia, J. S. Geronimo, D. P. Hardin, and B. W. Suter, "Design of prefilters for discrete multiwavelet transforms," IEEE Trans. Signal Process., vol. 44, pp. 25-35, Jan. 1996.
- [4] V. Strela, P. N. Hellers, G. Strang, P. Topiwala, and C. Heil, "The application of multiwavelet filter banks to image processing", IEEE Trans. Image Process., vol. 8, pp. 548-563, Apr. 1999
- [5] R. M. Gray, "Vector Quantization," IEEE ASSP magazine, vol. 1, No.2, pp. 4-29, Apr. 1984
- [6] A. Gersho and R.Gray, "Vector Quantization and Signal Compression", Kluwer Academic Publishers, M.A, 1995.
- [7] M. Vetterli and G. Strang "Time-varying filter banks and multiwavelets," Sixth IEEE DSP workshop, Yosemite, 1994
- [8] S.G. Mallat, "A theory for multiresolution signal decomposition: The wavelet representation", IEEE Trans. Pattern Anal. Mech. Intell., vol. 11, pp. 674-693, Jul. 1989.
- [9] J. T. Miller, and C.C. Li, "Adaptive multiwavelet initialization", IEEE Trans. Signal Process., vol. 46, pp. 3282-3291, Dec. 1998.
- [10] V. Strela, "Multiwavelets: theory and application" PhD dissertation, Department of Mathematics, Massachusetts Institute of Technology, 1996.
- [11] Albert Cohen, I. Daubechies, G. Guleryuz and Micheal T.Orchard, "On the importance of combining wavelet-based nonlinear approximation with coding strategies", IEEE Trans. Information Theory, vol. 48, pp. 1895-1921, July 2002.
- [12] B.H. Juang and A. Gray, "Multiple stage vector quantization for speech coding", in Proc. IEEE Int. Conf. Acous., Speech, Signal processing (Paris, France), pp. 597-600, Apr. 1982.
- [13] M. B. Martin "Applications of Multiwavelets to Image Compression", Master Thesis, Department of Electrical Engineering, Virginia Tech, 1999.

S. Esakkirajan received his Bachelor of Science degree from Sadakathullah Appa College, Palayamkottai, Bachelor of Technology degree from Cochin University of Science and Technology. He received his postgraduate degree from PSG College of Technology. He is currently working as a lecturer in Instrumentation and Control Systems Engineering Department, PSG College of Technology, Coimbatore.

T. Veerakumar received his Bachelor of Engineering degree from RVS College of Engineering and Technology, Dindugal. He received his Master of

Engineering degree from PSG College of Technology, Coimbatore. He is currently working as a lecturer in Electronics and Communication Engineering Department, PSG College of Technology, Coimbatore.

V. Senthil Murugan received his Bachelor of Engineering degree from PSG College of Technology. He is currently working as a design engineer in Mahindra and Mahindra, Nasik, India.

Dr. P. Navaneethan is currently working as a Professor in Electrical and Electronics Engineering Department, PSG College of Technology, Coimbatore. He received his Bachelor of Engineering degree from Coimbatore Institute of Technology, Master of Engineering from Anna University and Doctorate degree from Indian Institute of Science, India.