

# Low-MAC FEC controller for JPEG2000 image transmission over IEEE 802.15.4

Kyu-Yeul Wang, Sang-Seol Lee, Jea-Yeon Song, Jea-Young Choi, Seong-Seob Shin, Dong-Sun Kim, and Duck-Jin Chung

**Abstract**—In this paper, we propose the low-MAC FEC controller for practical implementation of JPEG2000 image transmission using IEEE 802.15.4. The proposed low-MAC FEC controller has very small HW size and spends little computation to estimate channel state. Because of this advantage, it is acceptable to apply IEEE 802.15.4 which has to operate more than 1 year with battery. For the image transmission, we integrate the low-MAC FEC controller and RCPC coder in sensor node of LR-WPAN. The modified sensor node has increase of 3% hardware size than conventional zigbee sensor node.

**Keywords**—FEC, IEEE 802.15.4, JPEG2000, low-MAC.

## I. INTRODUCTION

THE image transmission over conventional wireless network requires broadband and long data transmission time and moreover it even cannot be done at the low Signal-to-Noise Ratio (SNR) channel condition. To ameliorate this shortcoming, there are some studies. But, there are few studies about JPEG2000 image transmission over IEEE 802.15.4 and hardware for efficient image transmission. Therefore, in our study, we proposed Low-MAC Forward Error Correction (FEC) controller for low-rate wireless sensor network.

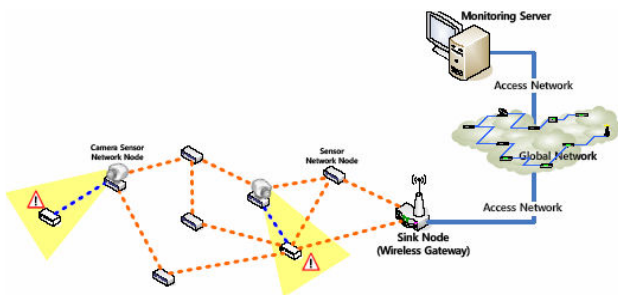

Fig. 1 Image Sensor Network

Kyu-Yeul Wang, Sang-Seol Lee, Jea-Young Choi, and Duck-Jin Chung are with School of information and communication engineering, INHA University, Incheon, Korea. (phone: +82-32-874-1663; fax: +82-32-864-1664; e-mails: wangky1007@inhaian.net, djchung@inha.ac.kr)

Dong-Sun Kim was with INHA University, Inchoen, Korea. He is now with the DxB communication convergence research center, Korea Electronics Technology Institute, Gyeonggi-do, Korea (e-mail: dskim@keti.re.kr).

This article is organized as follows. In section II, we look around previous studies that researched JPEG2000 image transmission over various wireless networks. In section III, we describe proposed low-MAC FEC controller about workflow and implementation. And then we explain the implementation results of the proposed low-MAC FEC controller in the section IV. Finally, in the section V, we make conclusion of this paper.

## II. PREVIOUS STUDY OVERVIEW

The application of the IEEE 802.15.4 is defined as low rate data or control signal transmission by zigbee alliance. But the studies about image transmission using IEEE 802.15.4 [3] and test-bed design [4][5] are investigated ahead. But, there are few studies about reliance of image transmission over wireless sensor network. In the previous studies like PSFQ [6] and RMST [7], they focused on image data transmission to specific node within minimum re-transmission. But, the multi-path image data transmission used in previous studies had a weak point because the system can cause multiple data transmission overhead in the bad channel condition. Especially, when the compressed image data is transmitted, the re-transmission resulting from the transmission error or image decoding failure would be controversial issue in the image transmission application. The sensor network like an IEEE 802.15.4 use low-end embedded processor. This processor doesn't have sufficient processing capacity for handling protocol and its processing power is closely related with battery life. Therefore, it couldn't operate for a long tract of time if it needs to treat theses computation. And reference [8] [9] proposed Unequal Error Protection (UEP) based on analysis of JPEG2000 bit-stream and error resilient tools. These works doesn't have practical implementation method to apply the proposed JPEG2000 bit-stream transmission scheme to wireless network. As the results, we proposed the method to reduce data re-transmission for JPEG2000 image transmission over IEEE 802.15.4 and low-MAC FEC controller for efficient implementation and reduction of computational efforts.

## III. PROPOSED LOW-MAC FEC CONTROLLER

If we use conventional data transmission method of zigbee for image transmission, the re-transmission is occurred in the case of failure of Start-of-Frame Delimiter (SFD) detection or error detection in the Cyclic Redundancy Check (CRC). But JPEG2000 bit-stream includes error resilient tools like a start of packet (SOP) marker, error resilient termination (ERTERM),

and segmentation mark (SEGMARK). If there are a few errors in the transmitted bit stream, the error is robustly recovered because of error resilient tools. So, the image transmission using data transmission method of zigbee is not acceptable because it brings about re-transmission overhead.

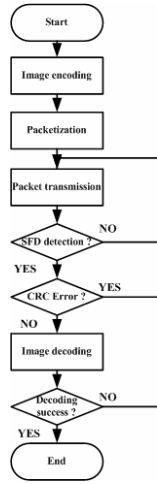

Fig. 2 Data Transmission flow using conventional IEEE 802.15.4

Therefore, we can achieve the efficient JPEG2000 image transmission with modifying the conventional data transmission scheme of zigbee. For this, we propose the FEC decision scheme based on previous study [8]. To decide code rate of channel coder, we simulated CRC check failure rate and SFD detection failure rate according to channel condition.

With this result, we decide the code rate for JPEG2000 bit-stream protection. First of all, we estimate channel by means of PHY protocol data unit (PPDU) transmission last 10 times. In the procedure, we decide the code rate as a following pseudo code.

TABLE I  
 PSEUDO CODE FOR CODE RATE DECISION

```
// initialization
CR = 1/2; // code rate 1/2
NACK = 0; // reset the number of NACK
For (i=1; i<=10; i++) //Transmit 10 PPDU;
{
    Count the number of ARQ;
    if (NACK == 0){
        CR = 1;
        re-transmit the image;}
    else If ( NACK <= 2){
        CR = 1/2;
        continue the transmission;}
    else if ( NACK <= 7){
        CR = 1/3;
        re-transmit the image;}
    else{
        CR=1/4;
        re-transmit the image;}
} //end
```

To implement image transmission scheme, we need to modify data transmission mechanism between transmitter and receiver. In the JPEG2000 image transmission mode, first of all, transmitter announces receiver that the transmitting data is JPEG2000 image bit-stream and then the receiver accepts the data even if there are some errors and decodes the bit-stream. If the receiver finds the error in the CRC checking, it transmits the NACK signal to the transmitter. But the transmitter doesn't re-transmit the PPDU. The NACK signal is used for channel estimation during JPEG2000 image transmission. The error in the transmitted bit-stream is canceled with viterbi decoder or JPEG2000 error resilient tools. The received bit-stream is used for JPEG2000 image decoding. If the decoding is failed, the receiver announces the failure to the transmitter to retransmit JPEG2000 bit-stream.

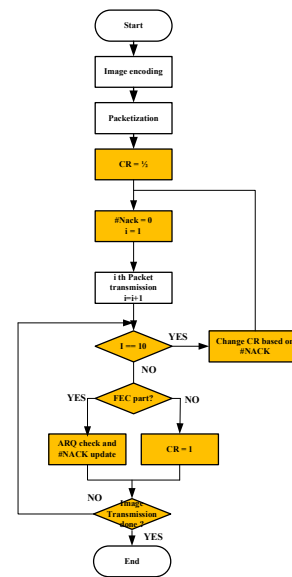

(a) Transmitter

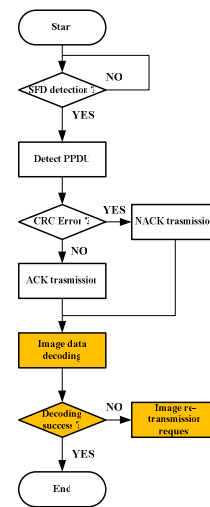

(b) Receiver

Fig. 3 Modified workflow of IEEE 802.15.4 for the JPEG2000 image Transmission

The transmitted JPEG2000 bit-stream is encoded by using gray level 512x512 lena image which is compressed at the bit rate 0.5 bpp with JPEG2000 error resilient tools. We also assigned convolutional code as a FEC at initial 12% of the bit-stream [8].

We simulated the proposed JPEG2000 transmission method. The simulation results are averaged through 100 times experiments. The simulation results depict that the re-transmission is reduced about 72% at the SNR -2 channel without decrease of image quality.

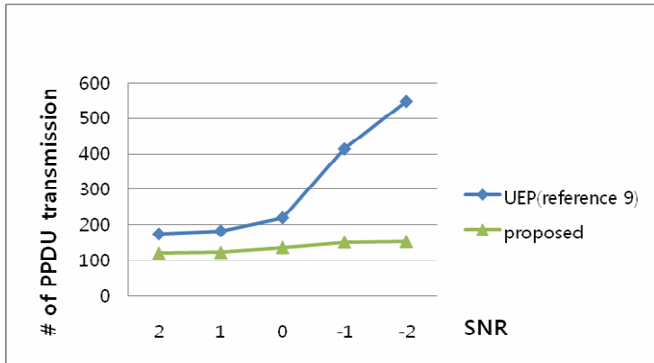

Fig. 4 The number of PPDU transmission per image

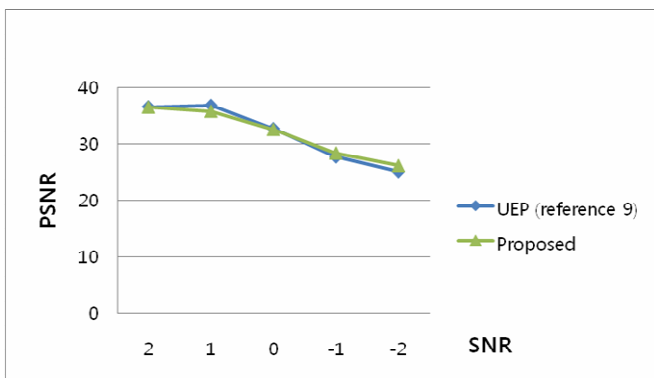
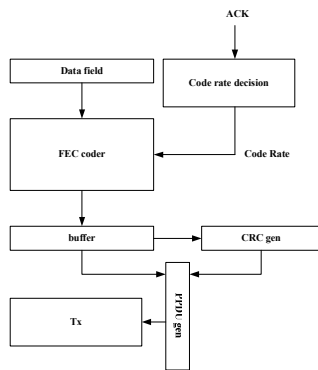
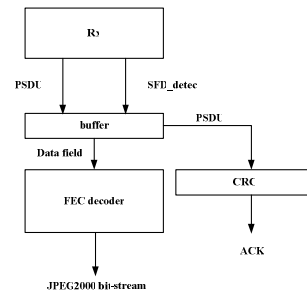

Fig. 5 Image quality according to Image transmission method

#### IV. IMPLEMENTATION RESULTS OF LOW-MAC FEC CONTROLLER



(a) Transmitter



(b) Receiver

Fig. 6 Proposed low-MAC FEC controller

If we use the proposed JPEG2000 bit-stream transmission method, the transmission can be done with reduced transmission efforts. We proposed low-MAC FEC controller to apply the proposed mechanism to IEEE 802.15.4.

The proposed low-MAC controller estimates channel with simple computation. So, it consume little power and computation time. In fine, the proposed low-MAC FEC controller is acceptable in IEEE 802.15.4

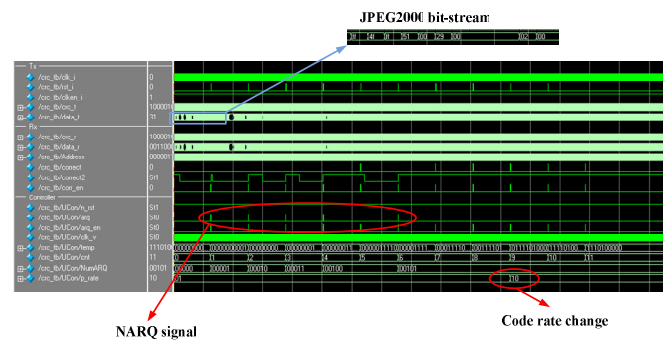

Fig. 7 Channel coding rate decision using low-MAC controller

Fig. 7 depicts the code rate decision process based on NACK signal which is decided by low-MAC FEC controller. The simulation is performed with channel BER which correspond to 10-2. There are 5 NACK signal in the 10 times PPDU transmissions. So, the low- MAC FEC channel controller computes channel SNR to -2. As a result, the low-MAC FEC controller decide the code rate to 1/3 which is proposed in section III.

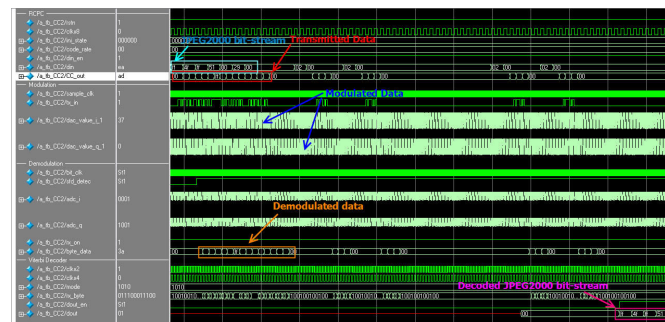

Fig. 8 Timing simulation

For the timing simulation, we use modelsim 6.0c and SDF (Standard Delay File) which is synthesized by ISE 9.2i. The JPEG2000 bit-stream which is input of Rate Compatible Punctured Convolution (RCPC) coder is identical to decoded bit-stream by viterbi decoder.

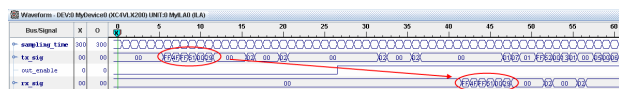

Fig. 9 Verification using chip-scope

We verified the design by downloading at virtex-4 xc4vlx200. We prove the input signal of transmitter and reconstructed signal of receiver. The proving signals are identical with timing signal results, respectively. The proposed HW is synthesized with magna chip 0.18 library by using design compiler of synopsys inc. The synthesization results are described in the following Table II.

TABLE II  
 UNITS FOR MAGNETIC PROPERTIES

		Gate count	Ratio
IEEE 802.15.4	Sensor	37877	1
	monitor	37877	1
Reference[9]	Sensor	38524	1.02
	Monitor	249166	6.58
proposed	Sensor	39162	1.03
	Monitor	249166	6.58

The proposed low-MAC FEC controller is composed of 638 gates. On the other hand, the monitoring system has a huge increase in gate count because of viterbi decoder as a FEC decoder. But, in the sensor network, the monitoring system is high performance and connected at the power line. The increases of the monitoring system's HW size and computational efforts are not critical consideration. In contrast with monitoring system, the sensor node which needs to operate with battery includes slight increase of 1285 gate and estimates channel state with a few computations.

## V. CONCLUSION

If the re-transmission scheme is used for image transmission, it causes network congestion and reduction of network operation time. Because of this, re-transmission scheme is not acceptable in image transmission. The proposed low-MAC FEC controller estimate channel state with little computation and it has slight increase of gate counts. Therefore, it is suitable for the image transmission application using IEEE 802.15.4 the zigbee sensor node has 3% increase of the HW size by integrating the proposed low-MAC controller and RCPC coder.

## ACKNOWLEDGMENT

This work was supported by "System IC 2010" project of Korea Ministry of Knowledge Economy.

## REFERENCES

- [1] JPEG2000 Part I: Final Draft International Standard (ISO/IEC FDIS15444-1), *ISO/IEC JTC1/SC29/WG1/N1855*, 2000.
- [2] IEEE Standard for 802.15: Wireless Medium Access Control (MAC) and Physical Layer (PHY) Specifications for Low Rate Wireless Personal Area Networks (LR-WPANs), 2006.
- [3] Georgiy Pekhteryev, Zafer Sahinoglu, Philip Orlik, Ghulam Bhatti, "Image Transmission over IEEE 802.15.4 and Zigbee Networks," *ISCAS 2005*, pp. 3539-3542.
- [4] Teresa Ko, ZainulM Charbiwala, Shaan Ahmadian, Mohammad Rahimi, "Exploring Tradeoffs in Accuracy, Energy and Latency of Scale Invariant Feature Transform in Wireless Camera Networks," *ICDSC 2007*, pp. 313-320.
- [5] Stephan Hengstler, Hamid Aghajan, "WiSNAP: A Wireless Image Sensor Network Application Platform," *TRIDENTCOM 2006*, March 2006.
- [6] Wan, C.-Y., Campbell, A.T., Krishnamurthy, L., "Pump-slowly, fetch-quickly (PSFQ): a reliable transport protocol for sensor networks," *IEEE Journal on Selected Areas in Communications*, Vol. 23, No. 4, pp. 862-872, 2005.
- [7] Stann, F., Heidemann, J., "RMST: reliable data transport in sensor networks," *IEEE International Workshop on Sensor Network Protocol and Applications*, pp. 102-112, 2003.
- [8] Kyu-Yeul Wang, Seung-Yerl Lee, Byung-Soo Kim, Sang-Seol Lee, Jea-Yeon Song, Dong-Sun Kim, Duck-Jin Chung, "Robust JPEG2000 Image Transmission over IEEE 802.15.4," *IEEE International Symposium on Electronic Design, Test and Application 2008*, pp.253-257.
- [9] V. S. Sanchez and M. K. Mandal, "Robust transmission of JPEG2000 images over noisy channels," *IEEE Transactions on Consumer Electronics*, Vol. 48, No. 3, Aug. 2002.