

# Morphology of Machined Surfaces from Electro Discharge Sawing and Sinking Electro Discharge Machining

N. Nagabhushana Ramesh, Kalley Harinarayana, T. Raghavender Reddy, and B. Balu Naik

**Abstract**—Electro Discharge Sawing is a hybrid process combining the features of SEDM and ECM. Its major characteristic is extremely fast erosion rate compare to either of the above processes. This paper brings out its relative feature of SEDM and EDS about their erosion rates, surface roughness, and morphology of machined surfaces.

**Keywords**—Electro Chemical Machining (ECM), Electro Discharge Sawing (EDS), Sinking Electro Discharge Machining (SEDM).

## I. INTRODUCTION

ELECTRO discharge machining (EDM) finds extensive application for machining exotic materials and complex shapes. But its slow machining rates are a major limitation for its application for sawing of large billets or bar-stocks of high strength materials. Since sawing does not require good surface finish, the modified EDM process combines the features of Electrochemical machining with EDM to obtain very high machining rates. This basically involves replacement of dielectric of EDM with an electrolyte [1].

Both the processes employ pulsed power sources. The pulse time has two parts i.e., pulse on time ( $T_{on}$ ) and pulse off time ( $T_{off}$ ). The off time facilitates deionisation of spark channel in the two EDM process and in EDS it permits the reactions of ECM, which are evolution of  $H_2$  at cathode and  $O_2$  at anode. In SEDM the dielectric in a tank surrounds the tool work set up to avoid fire hazard by preventing oxygen from spark zone. In EDS the working fluid is sprayed through nozzles to flow through the electrode-workpiece gap. Electrode in EDM is generally copper and preshaped. In EDS it is a mild steel belt with typical dimensions of 0.9 X 35 X 7450 mm and guided through ceramic assemblies.

The belt is formed by resistance butt welding and ground to uniform belt thickness. The belt runs at a speed of 16m/sec Pulse voltage (30 to 60V) and current (15 to 300A) are not significantly different than in SEDM. However it is the pulse

duration (as high as 20,000  $\mu s$  compared to 100  $\mu s$  in SEDM) with negligible pulse off time (compared to about 40 to 50 percent in SEDM).

The working fluid is an electrolyte (Sodium silicate plus water with a specific gravity of 1.25). Similar to EDM it quenches and removes the eroded debris. The additional functions of the electrolyte are a) evolve hydrogen gas to promote ionization and ionic discharge (b) forms electrolytic cell (c) form passivation film on anode (work piece) to promote insulation and prevent short circuits. The continuous ionization and insulating film formation facilitates high pulse on time and low off times thus increasing effective pulse energies. The polarity in SEDM is electrode positive whereas in EDS it is electrode negative a feature of ECM to promote the features already discussed.

The Physical setup in the two processes is shown in Fig. 1.

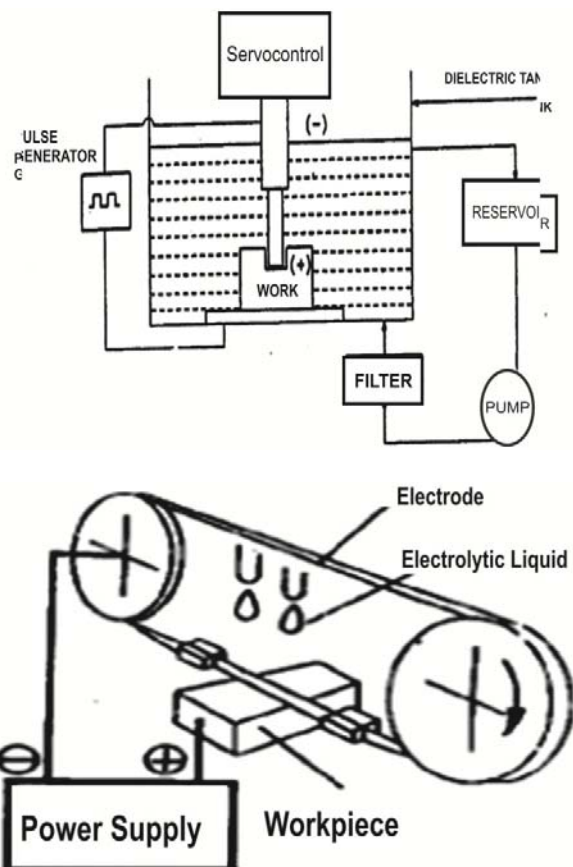

Fig. 1 Schematic diagrams of the electrical discharge machining processes

N. Nagabhushana Ramesh is Principal & Professor with the CMR Engineering College, Hyderabad, A.P., India (e-mail: nagabhushana.nnr@gmail.com).

Kalley Harinarayana is Research Scholar with the Jawaharlal Nehru Technological University, Hyderabad, A.P., India (e-mail: harinarayana.k62@gmail.com).

T. Raghavender Reddy is with the State Board of Technical Education and Training, Andhra Pradesh, India (e-mail: asee1sbtet@gmail.com).

B. Balu Naik is Professor with the Jawaharlal Nehru Technological University, Hyderabad, A.P., India (e-mail: banothbn@rediff.com).

## II. EXPERIMENTAL SETUP

The machining rates were evaluated in the SEDM setup and EDS set up. Owing to the absence of exact values of process parameters on the knobs of the control panels on these machines, it was not possible to select similar magnitudes of the process variables for direct and quantitative comparison. However to demonstrate the highly superior erosion rates in EDS, it was sought through selecting lowest values on EDS and highest possible values in SEDM from the respective technology guidelines provided by the manufacturers and listed below.

SEDM (Char miles):80v, pulse time 200 $\mu$ s, off time 50 $\mu$ m,

EDS (Electronica): 20v, 15Amps, Lowest pulse times [2]

Work Materials: HSS and Titanium (High melting point)

The surface finish was evaluated by Taylor - Hobson Talysurf which provided both the roughness profile and indices. Morphological features of eroded surfaces as also the debris were studied under scanning electron microscope (SEM).

## III. RESULTS AND DISCUSSIONS

### A. Machining Characteristics

The results on erosion rates and roughness are listed in Table I and Table II respectively with several replications range from.

The findings are as expected but illustrate the considerably high erosion rates and surface roughness in EDS compared to SEDM. Considerable fluctuations in the range of Ra were observed along EDS surfaces. This is attributed to nonuniform erosion owing to spark and arc discharges as well as short circuit current surge. The theory presented in the preceding section explains the reasons thereby. The eroded surfaces in EDS were very rough with poor appearance which interestingly was similar to those from conventional band saw. However they were highly superior to those from arc cutting plates which are extremely rough with extensive burrs. The geometric accuracy and surface finish of EDS surfaces have considerable superiority over surfaces from electrical arc cutting but inferior to SEDM surfaces. Since sawing operation requires only faster cuts but not any type of quality of machined surfaces. EDS is a highly suitable process for sawing large size bars, ingots etc of high strength materials.

The high energy densities of arc discharges create melting at the spot of its impingement and atomization of liquid metal by the arc forces and expanding gases. However the erosion rates in EDS are so high that the high energy pulses and arcing along may not be the reason but also the short circuits between electrode and work with current surge. In normal spark and arc discharge major amount of molten metal is retained and only a small part gets removed as atomized droplets.

But the explosive force of short circuits provides much higher expulsion and lower retention of molten metal. This aspect needs further exploration in the erosion mechanism of EDS. Erosion rates are higher in Titanium compared to HSS material as shown in Table I & Table II.

TABLE I  
 MACHINING RATES (RANGE) IN SEDM AND EDS WITH TWO LEVELS (HIGH AND LOW) CURRENT SETTINGS MG/MIN

| PROC<br>ESS | MATERIALS      |                 |                |                 |
|-------------|----------------|-----------------|----------------|-----------------|
|             | TITANIUM       |                 | HSS            |                 |
|             | LOW<br>CURRENT | HIGH<br>CURRENT | LOW<br>CURRENT | HIGH<br>CURRENT |
| EDS         | 185-224        | 210-277         | 151-183        | 212-247         |
| EDM         | 16.7-20.1      | 28.1-34.6       | 18.8-21.6      | 31.6-33.4       |

TABLE II  
 SURFACE ROUGHNESS ( $R_a$ ) RANGE IN SEDM AND EDS ( $\mu$ m)

| PROCE<br>SS | MATERIALS      |                 |                |                 |
|-------------|----------------|-----------------|----------------|-----------------|
|             | TITANIUM       |                 | HSS            |                 |
|             | LOW<br>CURRENT | HIGH<br>CURRENT | LOW<br>CURRENT | HIGH<br>CURRENT |
| EDS         | 6.0-9.2        | 8.5-14.1        | 3.6-8.7        | 6.3-11.4        |
| EDM         | 1.45-4.23      | 1.65-5.2        | 0.91-1.02      | 1.94-2.63       |

### B. Morphological Studies

The SEM photographs of the eroded surface of both electrode and work materials from both EDM and EDS are shown in Fig. 2.

There is considerable similarity in the erosive effect of sparks or arcs associated with EDM and EDS. Arcing being continuous local spark discharges, hence forth the word sparks will be employed for both the processes. The tool electrodes are made cathode in EDS and anode in EDM. In EDS the typical occurrence of passivation film formation on anode and

evolution of hydrogen at cathode for gaseous bridging of spark gap and ionization for sparks channel formation requires the type of polarity reversal employed. Larger pits on MS electrode in EDS (Fig. 2.a, b) compared to those on copper electrode of EDM and similar occurrence on work surfaces (Fig. 2.c. to h) indicate superior expulsion of molten metal from the spark attacked spots. The erosion in each case appears in mother for on and the high quenching effect of circulating fluid prevents vapourization. There is considerable retained metal which appears to have been resolidified at spark zones. The solidification shrinkage and resultant cracks [Fig. 2.c,d] are extensive in EDS owing to high quenching effect of water based electrolyte.

The eroded surface of Titanium, HSS show typical appearance associating with EDM [3] like burst blisters from dissolved gases, pock marks and craters after expulsion of molten metal from spark energy. This expulsion appears to be superior in EDS due to superior quenching from water based electrolyte which also promotes the oxidation tendency of aluminium [Fig. 2.f]. The erosive effect of sparks is also seen from the debris collected.

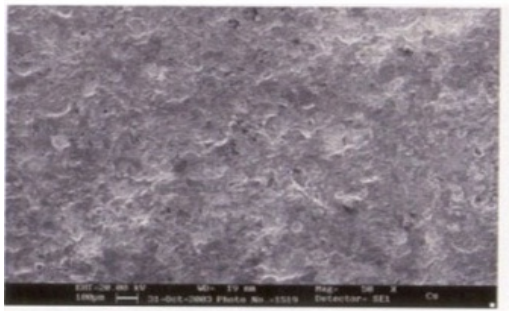

(a) Cu Electrode (EDM)

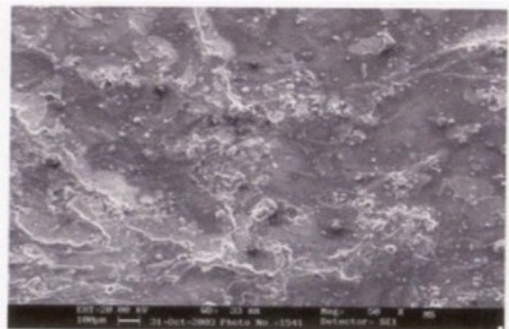

(b) MS Electrode (EDS)

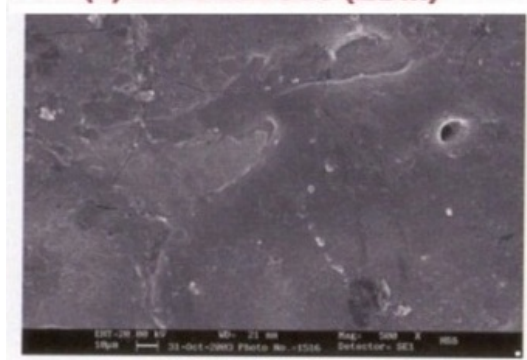

(c) HSS (EDM)

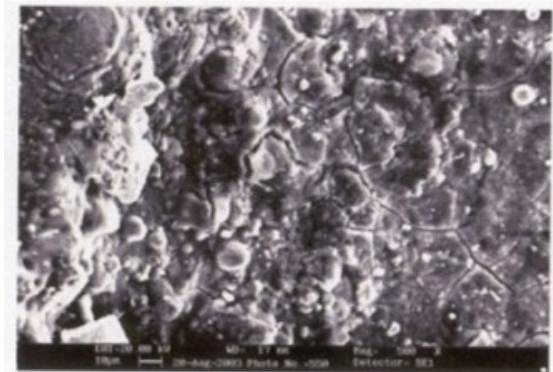

(d) HSS (EDS)

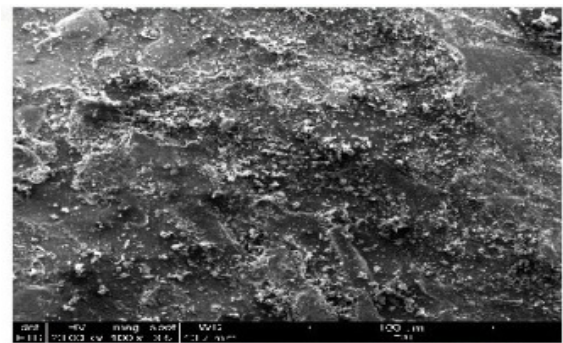

(e) Titanium (EDM)

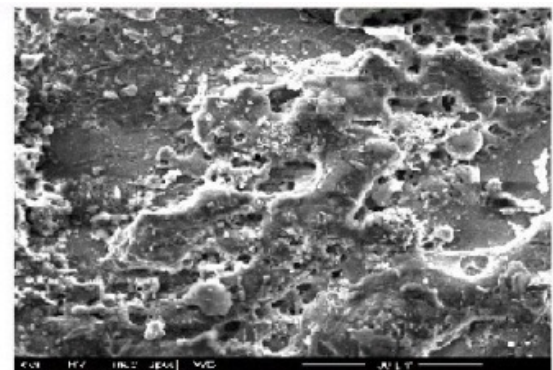

(f) Titanium (EDS)

Fig. 2 SEM Photomicrographs of electrode and Machined Surfaces

The erosion from molten state is clearly seen from the uniformly shaped spheroidal particles in EDM [Fig. 3.a]. However in EDS the high quenching rates from water based electrolyte is once again seen in the sludge formation with inadequate time for spheroidization [Fig. 3.b]. The low surface energies and oiliness of kerosene not only promotes uniform spheroidal debris [4] but also prevents their sticking.

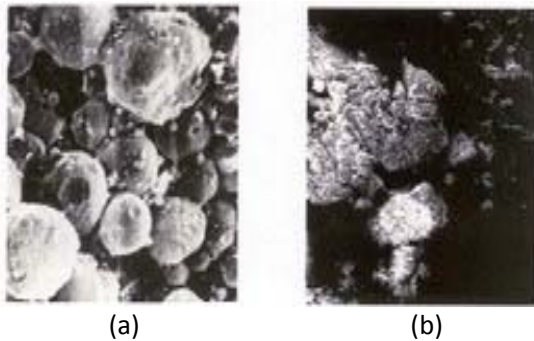

Fig. 3 Erosion debris from (a) SEDM (b) EDS  
EDM debris have discrete spheroidal shape where as  
EDS show the debris as sludge and bear significant similarity

#### IV. CONCLUSION

1. EDS has considerably higher erosion rates than EDM and is eminently suitable for sawing large bar stocks.
2. In both EDM and EDS, high thermal and electrical conductivity leads to poorer erosion rates.
3. Surface roughness follows the expected and normal pattern similar to that of erosion rates.
4. The erosion in both the cases is thermoelectric with melting and expulsion of molten droplets from the spots of sparks impingement.
5. There is considerable retained metal which resolidified and exhibits typical features of spark erosion in the form of gas pockets and solidification cracking.
6. High quenching effect of water based working fluid of EDS results in irregular debris which stick together and appear in sludge form.

#### REFERENCES

- [1] J.A. McGeough, A.B.Khayry, W. Munro, J.R. Crook - all, "Theoretical and Experimental Investigation of the Relative Effects of Spark Erosion and Electrochemical Dissolution in Electrochemical Arc Machining," *Annals of the CIRP*, 32(1)(1983), 113-118.
- [2] Electronica, "Electro-Discharge Sawing," *Manual-Electronica Machine Tools*, Pune, India (2003).
- [3] R.E. Williams and K.P. Rajurkar, "Study of Wire Electrical Discharge Machined Surface Characteristics," *Journal of Materials Processing Technology*, 28(1991), 127-137.
- [4] V.S.R. Murti and P.K. Philip, "An Analysis of Debris in Ultrasonic Assisted EDM," *Wear*, 117 (1987), 241 -250.

**N. Nagabushana. Ramesh** was born in Razole, East Godavari District, A.P, India on 04/11/1961. He completed his B.E in Mechanical Engineering and M.E in Production Engineering from Osmania University, Hyderabad, A.P, India. He did his Ph.D., in Mechanical Engineering with specialization as Production Engineering in the field of Electro Discharge Machining from Osmania University, Hyderabad, A.P, India

He worked as Professor in Mechanical Engineering Department with J.N.T.U & Osmania University Engineering colleges. He has also experience in industries with specialized fields like Tool Design, Production and Maintenance engineering. Presently he is working as Professor & Principal, C.M.R. Engineering College, Hyderabad A.P India. He presented and published papers 2 in International Journal, 14 International Conferences and 12 National Conferences. He is the Life Member of ISTE, India.

**K. Harinarayana** was born in Hyderabad, A.P., India on 01/06/1962. He completed his B.Tech., in (Mechanical Engineering) from S.V.University, Tirupathi, A.P., and M.Tech in Production Engineering from J.N.T.U, Hyderabad, A.P. Presently he is working as research scholar in J.N.T.U, Hyderabad.

He has an experience of 14 years in different industries and 9 years of teaching faculty with different university affiliated colleges. He presented papers at 1 National and 3 International conferences.

**T. Raghavender Reddy** was born in Nalgonda, A.P., India on 03/06/1960. He completed his B.Tech., in Mechanical Engineering from Osmania University, Hyderabad, A.P., and M.Tech in Industrial Engineering from J.N.T.U, Hyderabad, A.P.. Earlier he worked as Assistant Secretary in State Board of Technical Education & Training, A.P, Hyderabad .He presented papers at 1 National and 1 International Conferences.

Presently he is working as Head of Mechanical Engineer- Ing department, Government Polytechnic, Nalgonda, A.P.,

**B. Balu Naik** was born in Warangal, A.P., India on 02/04/1969. He completed his B.Tech., in Mechanical Engineering from J.N.T.U, Hyderabad, A.P., and M.Tech in Production Engineering from J.N.T.U, Hyderabad, A.P. He did his Ph.D., in Energy Systems from J.N.T.U. Hyderabad.

Presently he is working as Professor in Mechanical Engineering and Deputy Director at U.G.C. Academic Staff College, J.N.T.U, and Hyderabad. He presented papers at 10 National conferences and 6 International conferences. He is the Life Member of ISTE, India.