

Multimachine Power System Stabilizers Design Using PSO Algorithm

H. Shayeghi, A. Safari, H. A. Shayanfar

Abstract—In this paper, multiobjective design of multi-machine Power System Stabilizers (PSSs) using Particle Swarm Optimization (PSO) is presented. The stabilizers are tuned to simultaneously shift the lightly damped and undamped electro-mechanical modes of all machines to a prescribed zone in the s -plane. A multiobjective problem is formulated to optimize a composite set of objective functions comprising the damping factor, and the damping ratio of the lightly damped electromechanical modes. The PSSs parameters tuning problem is converted to an optimization problem which is solved by PSO with the eigenvalue-based multiobjective function. The proposed PSO based PSSs is tested on a multimachine power system under different operating conditions and disturbances through eigenvalue analysis and some performance indices to illustrate its robust performance.

Keywords—PSS Design, Particle Swarm Optimization, Dynamic Stability, Multiobjective Optimization.

I. INTRODUCTION

STABILITY of power systems is one of the most important aspects in electric system operation. This arises from the fact that the power system must maintain frequency and voltage levels in the desired level, under any disturbance, like a sudden increase in the load, loss of one generator or switching out of a transmission line, during a fault [1]. Since the development of interconnection of large electric power systems, there have been spontaneous system oscillations at very low frequencies in order of 0.2 to 3.0 Hz. Once started, they would continue for a long period of time. In some cases, they continue to grow, causing system separation if no adequate damping is available. Moreover, low-frequency oscillations present limitations on the power-transfer capability. To enhance system damping, the generators are equipped with power system stabilizers (PSSs) that provide supplementary feedback stabilizing signals in the excitation systems. PSSs augment the power system stability limit and extend the power-transfer capability by enhancing the system damping of low-frequency oscillations associated with the electromechanical modes [2].

H. Shayeghi is with the Department of Technical Eng., University of Mohaghegh Ardabili, Ardabil, Iran (corresponding author to provide phone: 98-551-2910; fax: 98-551-2904; e-mail: hshayeghi@gmail.com).

A. Safari with the Electrical Engineering Department, Zanjan University, Zanjan, Iran.

H.A. Shayanfar with the Center of Excellence for Power System Automation and Operation, Electrical Eng. Department, Iran University of Science and Technology, Tehran, Iran.

The eigenvalue sensitivity analysis has been used for PSS design in many literatures under deterministic system operating conditions. To consider the effect of more system operating factors, the technique of probabilistic eigenvalue analysis was proposed and has been applied for the parameter design of power system damping controllers [2-3]. In the probabilistic eigenvalue analysis the system stability is enhanced by shifting the distribution ranges of the critical eigenvalues to the left side of the complex plane. A new approach for the optimal decentralized design of PSSs with output feedback is investigated in [4]. If PSSs with complete state feedback control scheme are adopted, the requirements of estimators and centralized controls may be used for the unavailable states and control signals. However, these increase the hardware cost and reduce the reliability of the control system. Novel intelligent control design methods such as fuzzy logic controllers [5-6] and artificial neural network controllers [7] have been used as PSSs. Unlike other classical control methods fuzzy logic and neural network controllers are model-free controllers; i.e. they do not require an exact mathematical model of the controlled system. Moreover, speed and robustness are the most significant properties in comparison to other classical schemes.

Despite the potential of modern control techniques with different structures, power system utilities still prefer the conventional lead-lag power system stabilizer (CPSS) structure [8-9]. The reasons behind that might be the ease of online tuning and the lack of assurance of the stability related to some adaptive or variable structure techniques. On the other hand, Kundur et al. [10] have presented a comprehensive analysis of the effects of the different CPSS parameters on the overall dynamic performance of the power system. It is shown that the appropriate selection of CPSS parameters results in satisfactory performance during system upsets. In addition, Gibbard [11] demonstrated that the CPSS provide satisfactory damping performance over a wide range of system loading conditions. The robustness nature of the CPSS is due to the fact that the torque-reference voltage transfer function remains approximately invariant over a wide range of operating conditions. A gradient procedure for optimization of PSS parameters at different operating conditions is presented in [12]. Unfortunately, the optimization process requires computations of sensitivity factors and eigenvectors at each iteration. This gives rise to heavy computational burden and slow convergence. Thus, conventional optimization methods that make use of derivatives and gradients are, in general, not able to locate or identify the global optimum, but for real-world applications, one is often content with a “good”

solution, even if it is not the best. Consequently, heuristic methods are widely used for global optimization problems.

Recently, global optimization techniques like genetic algorithms (GA), evolutionary programming, Tabu search, simulated annealing and rule based bacteria foraging [13-20] have been applied for PSS parameter optimization. These evolutionary algorithms are heuristic population-based search procedures that incorporate random variation and selection operators. Although, these methods seem to be good methods for the solution of PSS parameter optimization problem. However, when the system has a highly epistatic objective function (i.e. where parameters being optimized are highly correlated), and number of parameters to be optimized is large, then they have degraded efficiency to obtain global optimum solution and also simulation process use a lot of computing time. Moreover, in [13-14, 17, 19] the robust PSS design was formulated as a single objective function problem, and not all PSS parameter were considered adjustable. In order to overcome these drawbacks, a Particle Swarm Optimization (PSO) based PSS (PSOPSS) is proposed in this paper. In this study, PSO technique is used for optimal tuning of PSS parameter to improve optimization synthesis and the speed of algorithms convergence. PSO is a novel population based metaheuristic, which utilize the swarm intelligence generated by the cooperation and competition between the particle in a swarm and has emerged as a useful tool for engineering optimization. It has also been found to be robust in solving problems featuring non-linear, non-differentiability and high dimensionality [21-23]. PSO has been motivated by the behavior of organisms, such as fish schooling and bird flocking. Unlike the other heuristic techniques, it has a flexible and well-balanced mechanism to enhance the global and local exploration abilities. Also, it suffices to specify the objective function and to place finite bounds on the optimized parameters.

In this paper, the problem of robust PSS design is formulated as a multiobjective optimization problem and PSO is used to solve this problem. The multiobjective problem is concocted to optimize a composite set of two eigenvalue-based objective functions comprising the desired damping factor, and the desired damping ratio of the lightly damped and undamped electromechanical modes [16]. The stabilizers are automatically tuned with optimization an eigenvalue based multi-objective function by PSO to simultaneously shift the lightly damped and undamped electro-mechanical modes of all machines to a prescribed zone in the s-plane such that the relative stability is guaranteed and the time domain specifications concurrently secured. The effectiveness of the proposed PSO based PSS (PSOPSS) is tested on a multimachine power system under different operating conditions through eigenvalue analysis and some performance indices. Results evaluation show that the proposed method achieves good robust performance for damping low frequency oscillations under different operating conditions.

II. PROBLEM STATEMENT

A. Power system model

The complex nonlinear model related to an n-machine interconnected power system, can be described by a set of

differential- algebraic equations by assembling the models for each generator, load, and other devices such as controls in the system, and connecting them appropriately via the network algebraic equations. The generator in the power system is represented by Heffron-Philips model and the problem is to design the parameters of the power system stabilizers. In this study, the two-axis model [2] given in Appendix is used for time domain simulations. For a given operating condition, the multi-machine power system is linearized around the operating point. The closed loop eigenvalues of the system are computed and the desired objective functions are formulated using only the unstable or lightly damped electromechanical eigenvalues, keeping the constraints of keeping all the system modes stable under any condition.

B. PSS structure

The operating function of a PSS is to produce a proper torque on the rotor of the machine involved in such a way that the phase lag between the exciter input and the machine electrical torque is compensated. The supplementary stabilizing signal considered is one proportional to speed. A widely speed based used conventional PSS is considered throughout the study [2]. The transfer function of the *i*th PSS is given by:

$$U_i = K_i \frac{sT_w}{1+sT_w} \left[\frac{(1+sT_{1i})(1+sT_{3i})}{(1+sT_{2i})(1+sT_{4i})} \right] \Delta\omega_i(s) \quad (1)$$

Where, $\Delta\omega_i$ is the deviation in speed from the synchronous speed. This type of stabilizer consists of a washout filter, a dynamic compensator. The output signal is fed as a supplementary input signal, U_i , to the regulator of the excitation system. The washout filter, which essentially is a high pass filter, is used to reset the steady-state offset in the output of the PSS. The value of the time constant T_w is usually not critical and it can range from 0.5 to 20 s. In this paper, it is fixed to 10 s. The dynamic compensator is made up to two lead-lag stages and an additional gain. The adjustable PSS parameters are the gain of the PSS, K_i , and the time constants, T_{1i} - T_{4i} . The lead-lag block present in the system provides phase lead compensation for the phase lag that is introduced in the circuit between the exciter input and the electrical torque. The required phase lead can be derived from the lead-lag block even if the denominator portion consisting of T_{2i} and T_{4i} gives a fixed lag angle. Thus, to reduce the computational burden here, the values of T_{2i} and T_{4i} are kept constant at a reasonable value of 0.05 s and tuning of T_{1i} and T_{3i} are undertaken to achieve the net phase lead required by the system.

C. Objective function

1) Very often, the closed-loop modes are specified to have some degree of relative stability. In this case, the closed loop eigenvalues are constrained to lie to the left of a vertical line corresponding to a specified damping factor. The parameters of the PSS may be selected to minimize the following objective function [19]:

$$J_1 = \sum_{\sigma_i \geq \sigma_0} (\sigma_0 - \sigma_i)^2 \quad (2)$$

Where, σ_i is the real part of the *i*th eigenvalue, and σ_0 is a chosen threshold. The value of σ_0 represents the desirable level of system damping. This level can be achieved by

shifting the dominant eigenvalues to the left of $s=\sigma_0$ line in the s -plane. This also ensures some degree of relative stability. The condition $\sigma_i \geq \sigma_0$ is imposed on the evaluation of J_1 to consider only the unstable or poorly damped modes that mainly belong to the electromechanical ones. The relative stability is determined by the value of σ_0 . This will place the closed-loop eigenvalues in a sector in which $\sigma_i \leq \sigma_0$ as shown in Fig. 1-(a).

2) To limit the maximum overshoot, the parameters of the PSS may be selected to minimize the following objective function [24]:

$$J_2 = \sum_{\zeta_i \leq \zeta_0} (\zeta_0 - \zeta_i)^2 \quad (3)$$

Where ζ_i is the damping ratio of the i th eigenvalue. This will place the closed-loop eigenvalues in a wedge-shape sector in which $\zeta_i \geq \zeta_0$ as shown in Fig. 1-(b). In the case of J_2 , ζ_0 is the desired minimum damping ratio, which is to be achieved. It is necessary to mention here that if only particular eigenvalues need to be relocated, then only those eigenvalues should be taken into consideration in the computation of the objective function. This is usually the case

in dynamic stability where it is desired to relocate the electromechanical modes of oscillations.

3) The parameters of the PSS may be selected to minimize the following objective function:

$$J_3 = J_1 + aJ_2 \quad (4)$$

This will place the system closed-loop eigenvalues in the D-contour sector characterized by $\sigma_i \leq \sigma_0$ and $\zeta_i \geq \zeta_0$ [16] as shown in Fig. 1-(c).

If all the closed loop poles are located to the left of the contour, then the constraints on the damping factor and the real part of rotor mode eigenvalues are satisfied and a well damped small disturbance response is guaranteed.

The optimization problem can be stated as:

$$\text{Minimize } J_i \quad \text{Subject to:} \quad (5)$$

$$K_i^{\min} \leq K_i \leq K_i^{\max}$$

$$T_{1i}^{\min} \leq T_{1i} \leq T_{1i}^{\max}$$

$$T_{3i}^{\min} \leq T_{3i} \leq T_{3i}^{\max}$$

The proposed approach employs PSO to solve this optimization problem and search for an optimal set of PSS parameters, K_i , T_{1i} and T_{3i} ; $i=1, 2, 3$.

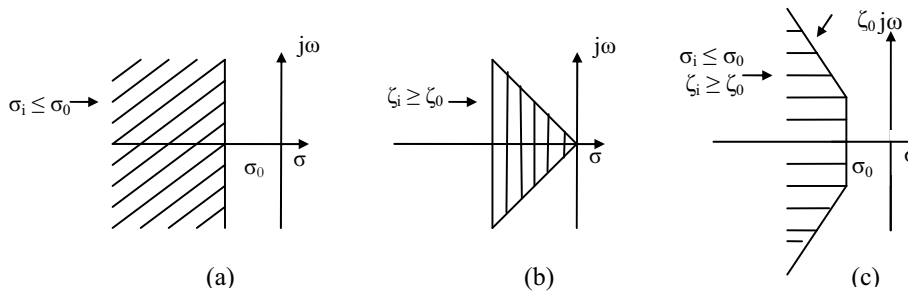

Fig. 1. Region of eigenvalue location for objective function.

III. PSO TECHNIQUE

Particle swarm optimization algorithm, which is tailored for optimizing difficult numerical functions and based on metaphor of human social interaction, is capable of mimicking the ability of human societies to process knowledge [22]. It has roots in two main component methodologies: artificial life (such as bird flocking, fish schooling and swarming); and, evolutionary computation. Its key concept is that potential solutions are flown through hyperspace and are accelerated towards better or more optimum solutions. Its paradigm can be implemented in simple form of computer codes and is computationally inexpensive in terms of both memory requirements and speed. It lies somewhere in between evolutionary programming and the genetic algorithms. As in evolutionary computation paradigms, the concept of fitness is employed and candidate solutions to the problem are termed particles or sometimes individuals, each of which adjusts its flying based on the flying experiences of both itself and its companion. It keeps track of its coordinates in hyperspace which are associated with its previous best fitness solution, and also of its counterpart corresponding to the overall best value acquired thus far by any other particle in the population. Vectors are taken as presentation of particles since most optimization problems are convenient for such variable

presentations. In fact, the fundamental principles of swarm intelligence are adaptability, diverse response, proximity, quality, and stability. It is adaptive corresponding to the change of the best group value. The allocation of responses between the individual and group values ensures a diversity of response. The higher dimensional space calculations of the PSO concept are performed over a series of time steps. The population is responding to the quality factors of the previous best individual values and the previous best group values. The principle of stability is adhered to since the population changes its state if and only if the best group value changes [23, 25]. As it is reported in [26], this optimization technique can be used to solve many of the same kinds of problems as GA, and does not suffer from some of GAs difficulties. It has also been found to be robust in solving problem featuring non-linear, non-differentiability and high-dimensionality. PSO is the search method to improve the speed of convergence and find the global optimum value of fitness function.

PSO starts with a population of random solutions “particles” in a D -dimension space. The i th particle is represented by $X_i = (x_{i1}, x_{i2}, \dots, x_{iD})$. Each particle keeps track of its coordinates in hyperspace, which are associated with the fittest solution it has achieved so far. The value of the fitness for particle i (pbest) is also stored as $P_i = (p_{i1}, p_{i2}, \dots, p_{iD})$.

The global version of the PSO keeps track of the overall best value (*gbest*), and its location, obtained thus far by any particle in the population. PSO consists of, at each step, changing the velocity of each particle toward its *pbest* and *gbest* according to Eq. (11). The velocity of particle *i* is represented as $V_i = (v_{i1}, v_{i2}, \dots, v_{iD})$. Acceleration is weighted by a random term, with separate random numbers being generated for acceleration toward *pbest* and *gbest*. The position of the *i*th particle is then updated according to Eq. (7) [22].

$$v_{id} = w \times v_{id} + c_1 \times rand() \times (P_{id} - x_{id}) + c_2 \times rand() \times (P_{gd} - x_{id}) \quad (6)$$

$$x_{id} = x_{id} + cv_{id} \quad (7)$$

Where, P_{id} and P_{gd} are *pbest* and *gbest*. Several modifications have been proposed in the literature to improve the PSO algorithm speed and convergence toward the global minimum. One modification is to introduce a local-oriented paradigm (*lbest*) with different neighborhoods. It is concluded that *gbest* version performs best in terms of median number of

iterations to converge. However, *Pbest* version with neighborhoods of two is most resistant to local minima. PSO algorithm is further improved via using a time decreasing inertia weight, which leads to a reduction in the number of iterations [28]. Figure 2 shows the flowchart of the proposed PSO algorithm.

This new approach features many advantages; it is simple, fast and easy to be coded. Also, its memory storage requirement is minimal. Moreover, this approach is advantageous over evolutionary and genetic algorithms in many ways. First, PSO has memory. That is, every particle remembers its best solution (local best) as well as the group best solution (global best). Another advantage of PSO is that the initial population of the PSO is maintained, and so there is no need for applying operators to the population, a process that is time and memory-storage-consuming. In addition, PSO is based on “constructive cooperation” between particles, in contrast with the genetic algorithms, which are based on “the survival of the fittest”.

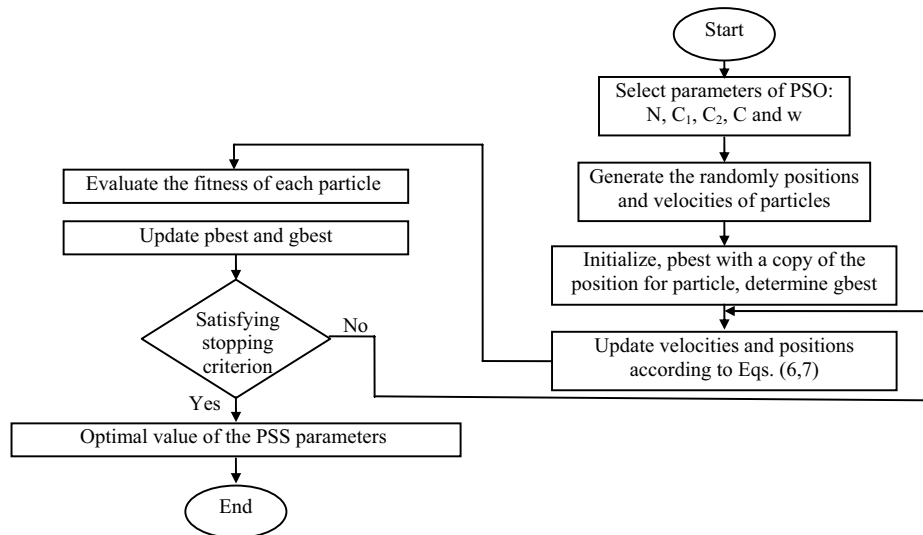

Fig. 2. Flowchart of the proposed PSO technique.

IV. CASE STUDY

In this study, the three-machine nine-bus power system shown in Fig. 3 is considered. Detail of the system data are given in Ref. [2].

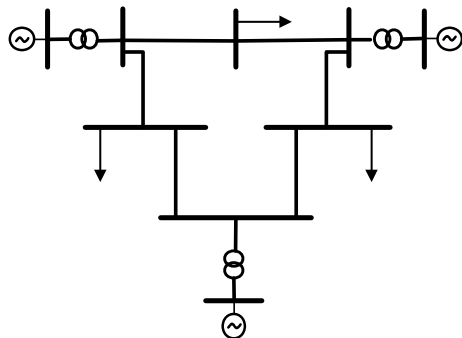

Fig. 3. Three-machine nine-bus power system.

To assess the effectiveness and robustness of the proposed method over a wide range of loading conditions, three different cases designated as nominal, light and heavy loading conditions are considered. The generator and system loading levels at these cases are given in Tables 1 and 2.

TABLE I
GENERATOR OPERATING CONDITIONS (IN PU)

Gen	Nominal		Heavy		Light	
	P	Q	P	Q	P	Q
G ₁	0.72	0.27	2.21	1.09	0.36	0.16
G ₂	1.63	0.07	1.92	0.56	0.80	-0.11
G ₃	0.85	-0.11	1.28	0.36	0.45	-0.20

TABLE II
LOADING CONDITIONS (IN PU)

Load	Nominal		Heavy		Light	
	P	Q	P	Q	P	Q
A	1.25	0.5	2.0	0.80	0.65	0.55
B	0.90	0.30	1.80	0.60	0.45	0.35
C	1.0	0.35	1.50	0.60	0.50	0.25

A. PSO-based PSS design and eigenvalue analysis

The PSS is connected to all machines in the test system. In the proposed method, we must tune the PSSs parameters optimally to improve the overall system dynamic stability in a robust way under different operating conditions and disturbances. To acquire an optimal combination, this paper employs PSO [22] to improve optimization synthesis and find the global optimum value of fitness function. In this study, the PSO module works offline. For the each PSS, the optimal setting of three parameters is determined by the PSO, i.e. 9 parameters to be optimized, namely K_b , T_{1b} and T_{3i} for $i= 1, 2, 3$. For our optimization problem, eigenvalue based multi objective functions as given in Eq. (5) is used.

In this work, the values of σ_0 , ζ_0 and a is considered as -1.5, 0.2 and 10, respectively. In order to acquire better performance, number of particle, particle size, number of iteration, C_1 , C_2 and C is chosen as 25, 9, 100, 2, 2 and 1, respectively. Also, the inertia weight, w , is linearly decreasing from 0.9 to 0.4. It should be noted that PSO algorithm is run several times and then optimal set of PSS parameters is selected. The convergence rate for different objective functions are shown in Fig. 4. The final values of the optimized parameters with both single objective functions J_1 , J_2 and the multi-objective function J_3 are given in Table 3.

The electromechanical modes and the damping ratios obtained for all operating conditions both with and without PSS in the system are given in Table 4. They are also depicted in the complex s-plane as shown in Fig. 5. When PSS is not installed, it can be seen that some of the modes are poorly

damped and in some cases, are unstable (highlighted in Table 4).

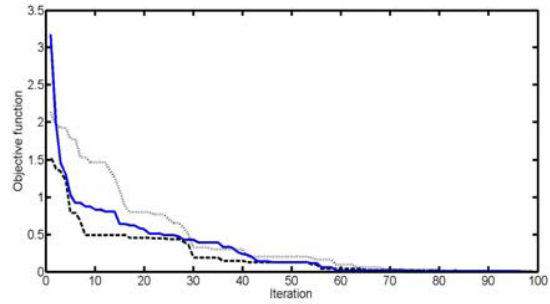

Fig. 4. Variations of objective functions, Solid (J_3), Dashed (J_2) and Doted (J_1)

Moreover, It is obvious that the electromechanical mode eigenvalues have been shifted to the left in s-plane and the system damping with the proposed method greatly improved and enhanced. Note that the parameter settings associated with J_1 are not able to shift the electromechanical modes in the region specified by $\zeta \geq 0.2$. The parameter settings associated with J_2 are not able to shift the electromechanical modes in the region specified by $\sigma \leq -1.5$. However, the parameter settings associated with the multiobjective function achieved both goals, namely $\zeta \geq 0.2$ and $\sigma \leq -1.5$. This clearly indicates that the single objective approach is not able to shift all electromechanical modes to the prescribed D-contour sector. Moreover, it is also clear that the system damping with the proposed J_3 tuned PSSs is greatly improved.

TABLE III
 OPTIMAL PSSS PARAMETERS WITH OBJECTIVE FUNCTIONS

Gen	J_1			J_2			J_3		
	K	T_1	T_3	K	T_1	T_3	K	T_1	T_3
G_1	78.34	0.0848	0.091	59.65	0.080	0.1251	50.51	0.1202	0.071
G_2	19.58	0.1821	0.1056	14.15	0.1743	0.1503	16.21	0.2122	0.083
G_3	36.2	0.1514	0.1871	25.87	0.1791	0.1187	29.67	0.1602	0.1907

TABLE IV
 EIGENVALUES OF ELECTROMECHANICAL MODES WITH AND WITHOUT PSSS

	Nominal	Heavy	Light
Without PSSs	2.0928 ± i4.1890 , -0.4469	2.3625 ± i9.2299 , -0.248	1.7279 ± i7.8521 , -0.215
	1.9378 ± i 5.6488 , -0.3245	2.9810 ± i4.7320 , -0.533	2.5451 ± i5.6182 , -0.4126
	-0.0537 ± i9.3626, 0.057	-0.1317 ± i4.5872, 0.0287	-0.3929 ± i2.3426, 0.1654
	-10.422 ± i5.0172, 0.9156	-10.943 ± i6.1334, 0.8723	-10.5856 ± i6.926, 0.4442
	-11.461 ± i2.2446, 0.9813	-10.628 ± i4.1433, 0.9317	-10.3769 ± i2.809, 0.965
PSSs with J_1	-1.9423 ± i23.048, 0.0840	-2.0644 ± i23.218, 0.0886	-3.5954 ± i22.493, 0.1578
	-4.8568 ± i15.746, 0.2947	-4.3076 ± i17.195, 0.2430	-1.8763 ± i20.508, 0.0911
	-1.5241 ± i10.400, 0.1426	-1.5386 ± i11.357, 0.1342	-1.6368 ± i10.918, 0.1483
	-1.5205 ± i 4.7851, 0.3028	-1.9414 ± i 6.9643, 0.2685	-2.6650 ± i 4.1054, 0.5445
	-1.6219 ± i2.2078, 0.592	-1.5037 ± i3.3199, 0.4126	-1.8525 ± i2.6769, 0.569
PSSs with J_2	-3.1641 ± i20.160, 0.2383	-7.1286 ± i18.003, 0.3682	-8.3518 ± i17.363, 0.4335
	-5.5697 ± i14.475, 0.2457	-3.8102 ± i17.019, 0.2169	-3.9573 ± i15.580, 0.2462
	-1.9746 ± i9.0094, 0.2343	-2.2260 ± i10.760, 0.2026	-2.1430 ± i10.135, 0.2069
	-0.9214 ± i5.7039, 0.2248	-1.7995 ± i7.6161, 0.230	-1.7208 ± i5.6866, 0.2896
	-1.6056 ± i2.6564, 0.4745	-1.0481 ± i4.3874, 0.2324	-1.6982 ± i4.4945, 0.3535
PSSs with J_3	-4.1726 ± i16.828, 0.2407	-4.6737 ± i17.140, 0.2631	-6.7108 ± i16.122, 0.3843
	-3.3363 ± i14.911, 0.2183	-3.0887 ± i15.005, 0.2016	-3.5852 ± i14.101, 0.2464
	-2.3224 ± i 9.6248, 0.2346	-2.0483 ± i8.9861, 0.2222	-1.8925 ± i9.0803, 0.2040
	-1.6347 ± i5.3947, 0.2900	-3.3485 ± i8.7138, 0.3587	-3.0027 ± i5.8930, 0.4540
	-2.0731 ± i2.5778, 0.6267	-1.5689 ± i4.2950, 0.3431	-2.1049 ± i4.2455, 0.4440

B. Nonlinear time-domain simulation

To evaluate the effectiveness of the PSO based PSSs tuned using the proposed multiobjective function A six-cycle three-phase fault disturbance at bus 7 at the end of line 5-7 is considered. The fault is cleared by tripping the line 5-7 with successful reclosure after 1.0 s. The performance of the PSSs tuned based on the multiobjective function is compared to that of the PSSs tuned using the single objective functions J_1 or J_2 for different operating conditions as given in Table 2. The

speed deviations of generators G1, G2 and G3 under the nominal, light and heavy loadings are shown in Figs. 6-8. It can be seen that the PSSs tuned using the multiobjective function achieves good robust and provides superior damping in comparison with the case when either of J_1 or J_2 are used. For completeness, the internal voltage of the all generators and transfer power, when the multiobjective function J_3 is used, are shown in Fig. 9.

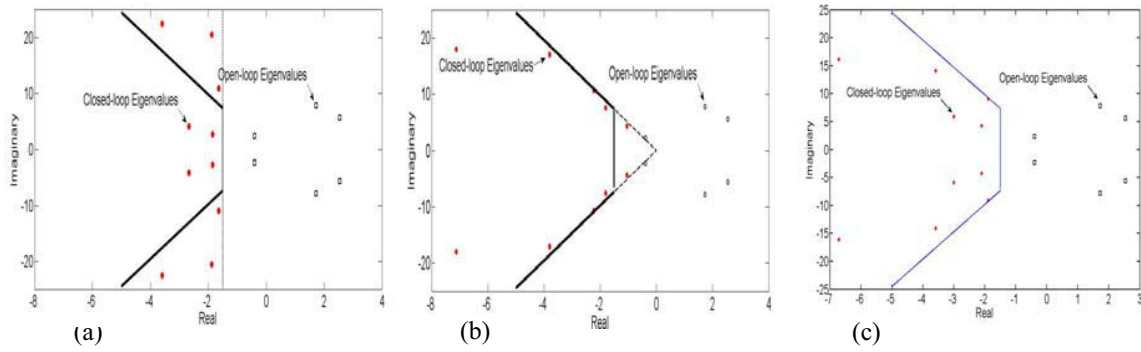

Fig. 5. Eigenvalues associated with electromechanical modes (J_1 , J_2 , and J_3)

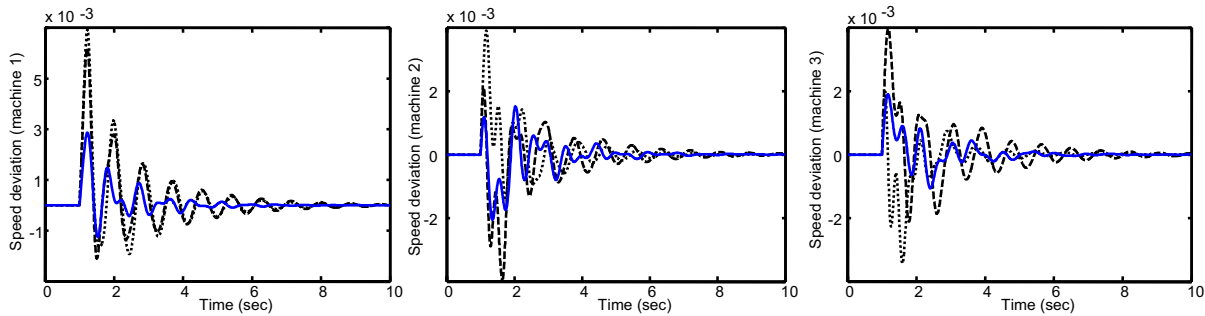

Fig. 6. The dynamic responses under nominal loading condition; Solid (J_3), Dashed (J_2) and Dotted (J_1).

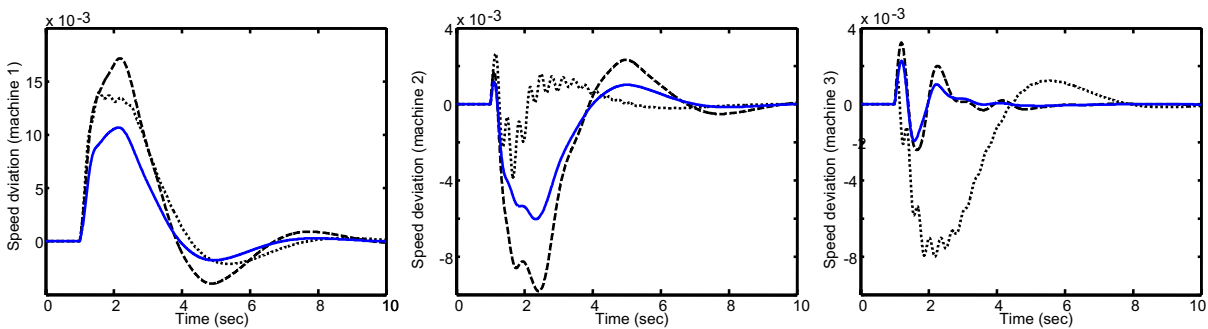

Fig. 7. The dynamic responses under heavy loading condition; Solid (J_3), Dashed (J_2) and Dotted (J_1).

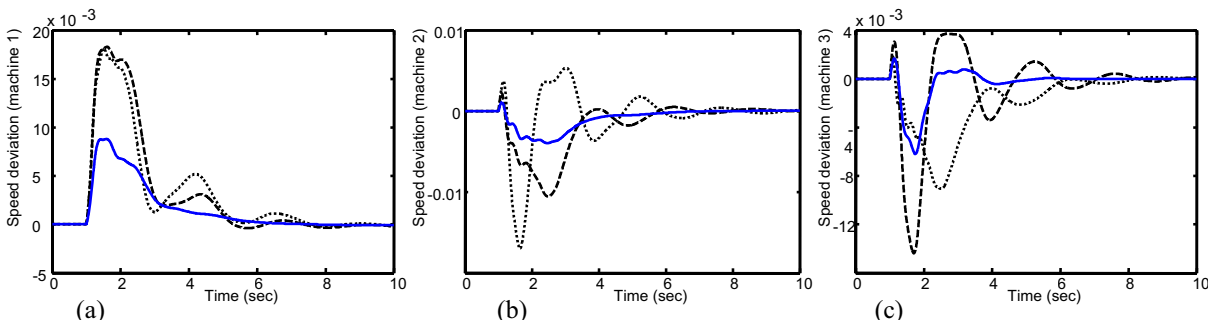

Fig. 8. The dynamic responses under light loading condition; Solid (J_3), Dashed (J_2) and Dotted (J_1).

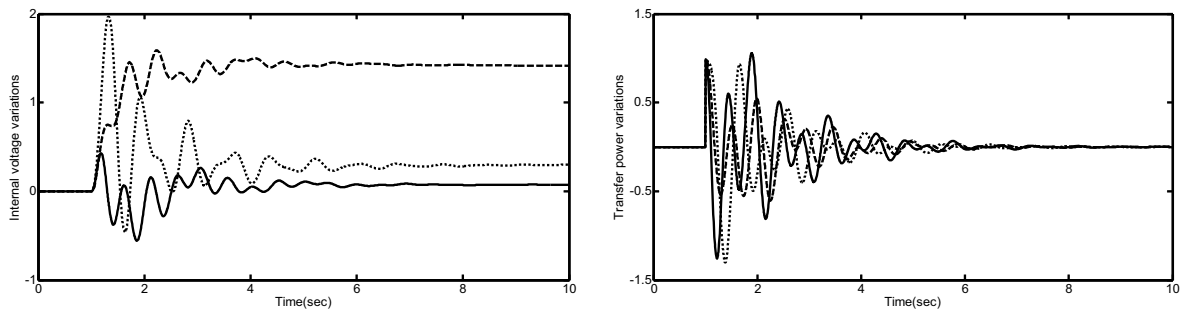

Fig. 9. Internal voltage and transfer power variations of generators; Solid (G_3), Dashed (G_2) and Dotted (G_1).

To demonstrate performance robustness of the proposed method, two performance indices: the Integral of the Time multiplied Absolute value of the Error (ITAE) and Figure of Demerit (FD) based on the system performance characteristics are being used as:

$$ITAE = \int_0^{10} t(|\Delta\omega_1| + |\Delta\omega_2| + |\Delta\omega_3|) dt \quad (9)$$

$$FD = (1000 \times OS)^2 + (1000 \times US)^2 + T_s^2 \quad (10)$$

Where, Overshoot (OS) Undershoot (US) and settling time of rotor angle deviation of all machines is considered for evaluation of the FD. It is worth mentioning that the lower the value of these indices is, the better the system response in terms of time-domain characteristics. Numerical results of performance robustness for all cases are listed in Table 5. It can be seen that the values of these system performance characteristics with the J_3 based tuned PSSs are much smaller compared to that of J_1 and J_2 based tuned PSSs. This demonstrates that the overshoot, undershoot settling time and speed deviations of all units are greatly reduced by applying the proposed J_3 based tuned PSSs.

TABLE V
 VALUES OF PERFORMANCE INDICES

Objective function	ITAE			FD		
	Nom.	Heavy	Light	Nom.	Heavy	Light
J_1	0.026	0.156	0.159	154.4	177.03	184.94
J_2	0.036	0.140	0.182	171.43	178.62	187.02
J_3	0.013	0.057	0.100	114.48	155.96	167.46

V. CONCLUSION

An optimal multiobjective design for multimachine power system stabilizers using PSO technique has been proposed. The stabilizers are tuned to simultaneously shift the lightly damped electromechanical modes of all plants to a prescribed zone in the s-plane. A multiobjective problem is formulated to optimize a composite set of objective functions comprising the damping factor, and the damping ratio of the lightly damped electromechanical modes. The design problem of the robustly PSSs parameters selection is converted into an optimization problem which is solved by a PSO technique with the eigenvalue-based multiobjective function.

Eigenvalue analysis give the satisfactory damping on system modes, especially the low-frequency modes, for systems with the proposed multiobjective function based tuned PSSs. Time-domain simulations show that the oscillations of synchronous machines can be quickly and effectively damped for power

systems with the proposed PSSs over a wide range of loading conditions. The system performance characteristics in terms of 'ITAE' and 'FD' indices reveal that the proposed multi-objective function based tuned PSSs demonstrates its superiority in computational complexity, success rate and solution quality.

APPENDIX: MACHINE MODELS

$$\dot{\delta}_i = \omega_b(\omega_i - 1) \quad (A.1)$$

$$\dot{\omega}_i = \frac{1}{M_i} (P_{mi} - P_{ei} - D_i(\omega_i - 1)) \quad (A.2)$$

$$\dot{E}'_{qi} = \frac{1}{T'_{doi}} (E_{fdi} - (x_{di} - x'_{di})i_{di} - E'_{qi}) \quad (A.3)$$

$$\dot{E}'_{fdi} = \frac{1}{T_{Ai}} (K_{Ai}(v_{refi} - v_i + u_i) - E'_{fdi}) \quad (A.4)$$

$$T_{ei} = E'_{qi}i_{qi} - (x_{qi} - x'_{di})i_{di}i_{qi} \quad (A.5)$$

- δ rotor angle
- ω rotor speed
- P_m mechanical input power
- P_e electrical output power
- E'_q internal voltage behind x'_d
- E'_{fd} equivalent excitation voltage
- T_e electric torque
- T'_{do} time constant of excitation circuit
- K_A regulator gain
- T_A regulator time constant
- v_{ref} reference voltage
- v terminal voltage

REFERENCES

- [1] X. Hugang, Ch. Haozhong, L. Haiyu, Optimal reactive power flow incorporating static voltage stability based on multi-objective adaptive immune algorithm, *Energy Conversion and Management*, Vol. 49, 2008, pp. 1175-1181.
- [2] H. Ping, Y. W. Kewen, T. Chitong, B. Xiaoyan, Studies of the improvement of probabilistic PSSs by using the single neuron model, *Electrical Power and Energy Systems*, Vol. 29, 2007, pp. 217-221.
- [3] C. Y. Chung, K. W. Wang, C. T. Tse, X. Y. Bian, and A. K. David, Probabilistic eigenvalue sensitivity analysis and PSS design in multimachine systems, *IEEE Trans. on Power Systems*, Vol. 18, No. 4, 2003, pp.1439 - 1445.

- [4] S. Lee, Optimal decentralised design for output-feedback power system stabilizers, *IEE Proc. Generation, Transmission and Distribution*, Vol. 152, No. 4, 2005, pp. 494-502.
- [5] J. Fraile-Ardanuy, P.J. Zufiria, Design and comparison of adaptive power system stabilizers based on neural fuzzy networks and genetic algorithms, *Neurocomputing*, Vol. 70, 2007, pp. 2902-2912.
- [6] Z. Barto, Robust control in a multimachine power system using adaptive neuro-fuzzy stabilizers, *IEE Proc. Generation, Transmission and Distribution*, Vol. 151, No. 2, 2004, pp.261-267.
- [7] R. Segal, A. Sharma, M.L. Kothari, A self-tuning power system stabilizer based on artificial neural network, *Electrical Power Energy Systems*, Vol. 26, 2004, pp. 423-430.
- [8] E. Larsen and D. Swann, Applying power system stabilizers, *IEEE Trans. Power App. Systems*, Vol. PAS-100, 1981, pp. 3017-3046.
- [9] G. T. Tse and S. K. Tso, Refinement of conventional PSS design in multimachine system by modal analysis, *IEEE Trans. on Power Systems*, Vol. 8, 1993, pp. 598-605.
- [10] P. Kundur, M. Klein, G. J. Rogers, and M. S. Zywno, Application of power system stabilizers for enhancement of overall system stability, *IEEE Trans. on Power Systems*, Vol. PAS-108, 1989, pp. 614-626.
- [11] M. J. Gibbard, Robust design of fixed-parameter power system stabilizers over a wide range of operating conditions, *IEEE Trans. on Power Systems*, Vol. 6, pp. 794-800, 1991.
- [12] V. A. Maslennikov, S. M. Ustinov, The optimization method for coordinated tuning of power system regulators, *Proceedings of the 12th Power Systems Computation Conference*, Dresden, Germany, 1996, pp. 70-75.
- [13] Y. L. Abdel-Magid, M. A. Abido, S. AI-Baiyat, A. H. Mantawy, Simultaneous stabilization of multimachine power systems via genetic algorithms, *IEEE Trans. on Power Systems*, Vol. 14, No. 4, 1999, pp. 1428-1439.
- [14] M. A. Abido, Y. L. Abdel-Magid, Hybridizing rule-based power system stabilizers with genetic algorithms, *IEEE Trans. on Power Systems*, Vol. 14, No. 2, 1999, pp.600 -607.
- [15] P. Zhang, A. H. Coonick, Coordinated synthesis of PSS parameters in multi-machine power systems using the method of inequalities applied to genetic algorithms, *IEEE Trans. on Power Systems*, Vol. 15, No. 2, 2000, pp. 811-816.
- [16] Y. L. Abdel-Magid, M. A. Abido, Optimal multiobjective design of robust power system stabilizers using genetic algorithms, *IEEE Trans. on Power Systems*, Vol. 18, No. 3, , 2003, pp. 1125 -1132.
- [17] Y. L. Abdel-Magid, M. A. Abido, A. H. Mantawy, Robust tuning of power system stabilizers in multimachine power systems. *IEEE Trans. on Power Systems*, Vol. 15, No. 2, 2000, pp. 735 -740.
- [18] M. A. Abido, Robust design of multimachine power system stabilizers using simulated annealing , *IEEE Trans. on Energy Conversion*, Vol. 15, No. 3, 2003, pp. 297-304.
- [19] M. A. Abido, Y. L. Abdel-Magid, Optimal design of power system stabilizers using evolutionary programming, *IEEE Trans. on Energy Conversion*, Vol. 17, No. 4, 2002, pp. 429-436.
- [20] S. Mishra, M. Tripathy, J. Nanda, Multi-machine power system stabilizer design by rule based bacteria foraging, *Electric Power Systems Research*, Vol. 77, 2007, pp. 1595-1607.
- [21] S. Yang, M. Wang, L. Jiao, A quantum particle swarm optimization, *Proceedings of the Congress on Evolutionary Computation*, Vol. 1, 2004, pp. 320-324.
- [22] J. Kennedy, R. Eberhart, Y. Shi, *Swarm intelligence*, Morgan Kaufmann Publishers, San Francisco, 2001.
- [23] M. Clerc, J. Kennedy, The particle swarm-explosion, stability, and convergence in a multidimensional complex space, *IEEE Trans. on Evolutionary Computation*, Vol. 6, No. 1, , 2002, pp. 58-73.
- [24] V. Mukherjee, S.P. Ghoshal, Comparison of intelligent fuzzy based AGC coordinated PID controlled and PSS controlled AVR system, *Electrical Power Energy Systems*, Vol. 29, 2007, pp. 679-689.
- [25] S. H. Zahiria, S. A. Seyedin, Swarm intelligence based classifiers, *Journal of Franklin Institute*, Vol. 344, 2007, 362-376.
- [26] X. M. Yu, X. Y. Xiong, Y. W. Wu, A PSO-based approach to optimal 28 capacitor placement with harmonic distortion consideration, *Electric Power Systems Research*, Vol. 71, 2004, pp. 27-33.